

Instruments

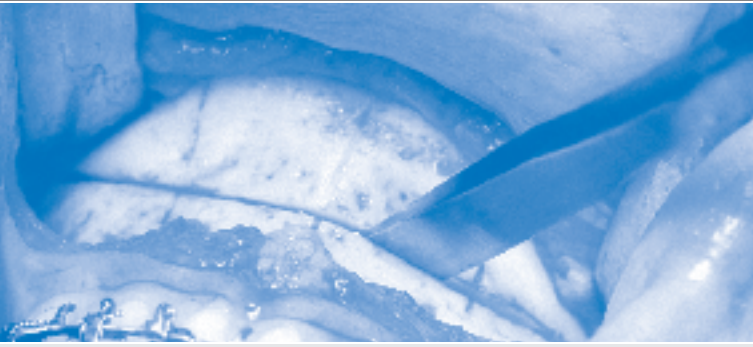

MEDICON

instruments

OMF SURGERY

Mund-, Kiefer- und Gesichtschirurgie
Oral and Maxillofacial Surgery
Cirugía oral y maxilofacial
Chirurgie maxillo-faciale
Chirurgia maxillo-facciale

medicon
Instrumente
the art of surgery



Instrumente für die Mund-, Kiefer- und Gesichtschirurgie
Instruments for Oral and Maxillofacial Surgery
Instrumentos para cirugía oral y maxilofacial
Instruments pour la chirurgie maxillo-faciale
Strumenti per la chirurgia maxillo-facciale



Die Entwicklung, Herstellung und der Vertrieb chirurgischer Instrumente und Implantate haben bei uns eine jahrzehntelange Tradition.

In unseren 13 Mitgliedsbetrieben werden über 30.000 verschiedene Artikel für die Humanmedizin gefertigt.

Wir haben es uns zur Aufgabe gemacht, Chirurgen und OP-Personal der MKG-Chirurgie mit innovativen Implantaten und Instrumenten zu versorgen, welche die Fortschritte in der Osteosynthese repräsentieren und somit die Lebensqualität der Patienten verbessern.

Our company has decades of experience in developing, manufacturing and selling surgical instruments and implants.

Our 13 member companies produce over 30,000 different items for human medicine. We have made it our mission to supply surgeons, and Cranio-Maxillofacial Surgery theatre staff with innovative implants and instruments that represent the progress made in osteosynthesis, thereby improving the quality of life of our patients.

El desarrollo, la fabricación y la distribución de implantes e instrumentos quirúrgicos representan para nosotros décadas de tradición. En nuestro taller de 13 miembros se fabrican más de 30.000 artículos diferentes para la medicina humana.

Nos hemos propuesto la tarea de abastecer a cirujanos y a personal de quirófano de la cirugía bucal y maxilofacial con innovadores implantes e instrumentos que suponen un progreso en osteosíntesis y, con ello, una mejora en la calidad de vida de los pacientes.

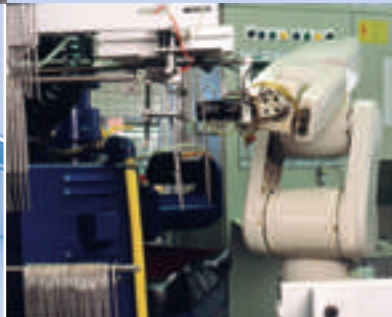

Le développement, la fabrication et la vente d'instruments chirurgicaux et d'implants sont pour nous une tradition longue de plusieurs décennies.

Nos 13 entreprises membres produisent plus de 30.000 articles différents dans le secteur de la médecine.

Nous nous sommes fixés pour objectif de fournir aux chirurgiens et au personnel opératoire actifs dans le secteur de la chirurgie CMF des implants et instruments innovateurs suivant le progrès dans l'ostéosynthèse, et donc d'améliorer la qualité de vie des patients.

Lo sviluppo, la produzione e la distribuzione di strumenti e impianti chirurgici hanno da noi una tradizione pluridecennale.

Nelle nostre 13 aziende associate, vengono preparati oltre 30.000 diversi articoli per la medicina umana.

Il compito che ci siamo proposti è quello di fornire ai chirurghi e personale della chirurgia OMF impianti e strumenti innovativi, che rappresentano i progressi nella osteosintesi e, quindi, migliorano la qualità di vita dei pazienti.

Der Ihnen vorliegende Katalog "Instrumente für die Mund-, Kiefer- und Gesichtschirurgie" bleibt unser Eigentum, auch wenn eine Leih- oder Schutzgebühr bezahlt wurde. Er darf nur zum Einkauf und Vertrieb der darin beschriebenen MEDICON-Produkte durch den dazu autorisierten Fachhandel und für die Bedarfsbeschaffung durch den jeweiligen Anwender verwendet werden. Seine Verwendung gegen unsere Interessen berechtigt uns zur sofortigen Rückforderung und möglichen weitergehenden Maßnahmen. Ohne unsere ausdrückliche, schriftliche Genehmigung darf dieser Katalog weder im Gesamten noch auszugsweise nachgedruckt oder kopiert werden.

This present "Instruments for Oral and Maxillofacial Surgery" catalogue remains exclusively our property even if a lending fee or charge has been paid for it. It shall only be used by specialized dealers to buy and sell MEDICON products or by individual users to meet their own requirements. In case of misuse we are entitled to recall the catalogue immediately and to take further steps if necessary. It is not allowed to reprint or copy this catalogue in whole or in parts without our written permission.

El presente catálogo "Instrumentos para cirugía oral y maxilofacial" sigue siendo nuestra propiedad aunque se ha pagado ciertos derechos de préstamo. Debe servir a los revendedores autorizados del ramo exclusivamente para la compra y la distribución de los productos MEDICON que describe, y a los especialistas y usuarios particulares para escoger los instrumentos necesarios para su abastecimiento. Su empleo abusivo en perjuicio de nuestros intereses, nos da derecho a exigir su devolución inmediata y a tomar todas las medidas ulteriores que juzguemos necesarias. Sin nuestro permiso expreso por escrito es prohibido reproducir o copiar este catálogo, tanto en su totalidad como en extractos.

Le présent catalogue "Instruments pour la chirurgie maxillo-faciale" demeure notre propriété, même après acquittement d'une taxe autorisée ou taxe de prêt. Il ne peut être utilisé que pour l'achat ou la vente des produits qui y sont décrits, par des spécialistes et étant autorisés et par l'utilisateur pour l'approvisionnement de ses besoins. Son utilisation contre nos intérêts nous autorise à une demande en restitution immédiate et à la prise éventuelle de mesures disciplinaires. Sans autorisation formelle écrite, ce catalogue ne peut être ni réimprimé, ni copié, que ce soit complètement ou partiellement.

Il presente catalogo "Strumenti per la chirurgia maxillo-facciale" rimane di nostra proprietà anche se è stato pagato un diritto di noleggio o di proprietà riservata. Esso può essere adoperato soltanto per l'acquisto e la vendita dei prodotti MEDICON ivi descritti attraverso il commercio specializzato e autorizzato o per l'approvvigionamento tramite chi, di volta in volta, li impiega. L'uso del catalogo contro i nostri interessi ci autorizza al suo immediato ritiro e possibili ulteriori provvedimenti. Senza la nostra esplicita autorizzazione scritta questo catalogo non può essere ristampato o copiato né integralmente né parzialmente.

Modelländerungen vorbehalten
Patterns are subject to change
Salvo modificaciones
Tous droits réservés des changements de modèle
Ci riserviamo la facoltà di cambiamenti nei modelli

Für Druckfehler übernehmen wir keinerlei Haftung
We are not liable for misprints
Declinamos toda responsabilidad por los errores de impresión que pueda contener este documento
Nous déclinons toute responsabilité en cas d'erreurs d'impression
Non ci assumiamo nessuna responsabilità per eventuali errori di stampa

Gedruckt in Deutschland
Printed in Germany
Impreso en Alemania
Imprimé en Allemagne
Stampato in Germania
Trykkt i Tyskland

© Copyright 06/2011, MEDICON eG, Tuttlingen, Germany





BASIC INSTRUMENTS

13 - 52

OMF INSTRUMENTS

53 - 120

SPECIALITIES

121 - 142

SET SUGGESTIONS

143 - 180

INDEX

181 - 216

A

Standardinstrumente Basic Instruments Instrumentos básicos Instruments de base Strumenti di base

A01	Skalpellsklingen und Skalpellgriffe Scalpel blades and scalpel handles Hojas de bisturí y mangos de bisturí Lames de bistouris et manches pour bistouris Lame per bisturi e manici per bisturi	14 - 16
A02	Scheren Scissors Tijeras Ciseaux Forbici	17 - 26
A03	Pinzetten Forceps Pinzas Pinces Pinze	27 - 35
A04	Nadelhalter Needle holders Porta-agujas Porte-aiguilles Portaghi	36 - 40
A05	Klemmen Clamps Pinzas Clamps Pinze	41 - 44
A06	Kornzangen Dressing forceps Pinzas para curaciones Pinces à pansements Pinze per medicazione	45
A07	Sauginstrumente Suction instruments Instrumentos de aspiración Instruments d'aspiration Strumenti per aspirazione	46 - 47
A08	Sonden Probes Estiletes Stylets Specilli	48 - 50

B**Instrumente für die Mund-, Kiefer- und Gesichtschirurgie
Instruments for Oral and Maxillofacial Surgery
Instrumentos para cirugía oral y maxilofacial
Instruments pour la chirurgie maxillo-faciale
Strumenti per la chirurgia maxillo-facciale**

B01	Retraktoren Retractors Separadores Ecarteurs Divaricatori	54 - 80
B02	Raspatorien und Elevatorien Raspatories and elevators Legras y elevadores Rugines et élévateurs Periostotomi ed elevatori	82 - 88
B03	Knocheninstrumente Bone instruments Instrumentos para huesos Instruments à os Strumenti per ossa	89 - 107
B04	Messinstrumente Measuring instruments Instrumentos para medir Instruments à mesurer Strumenti per misurare	108 - 110
B05	Drahtinstrumente Wire instruments Instrumentos para alambres Instruments pour fils métalliques Strumenti per fili d'acciaio	111 - 114
B06	Gaumenspalteninstrumente Cleft palate instruments Instrumentos para fisuras paladares Instruments pour fissures palatines Strumenti per fessure del palato	115 - 117
B07	Sinuslifting-Elevatorien Sinuslifting elevators Elevadores para sinuslifting Élévateurs pour sinuslifting Elevatori per sinuslifting	118 - 119

C**Spezialitäten
Specialities
Especialidad
Spécialités
Specialiti**

C01	“Kluba”-Spekulum und Nasenraspeln “Kluba” Speculum and nasal rasps “Kluba” Espéculo y raspadores nasales “Kluba” Spéculum et râpes nasales “Kluba” Specolo e raspe nasali	122 - 123
C02	Instrumente für den Beckenkamm Instruments for the pelvic crest Instrumentos para la cresta iliaca Instruments pour la crête iliaque Strumenti per la cresta iliaca	124 - 125
C03	Zylinder-Osteotome und Knochenmühlen Cylinder osteotomes and bone mills Osteótomos cilíndricos y molinos de hueso Ostéotomes cylindriques et moulins à os Osteotomi cilindrici e mulini per ossa	126 - 127
C04	Fibula-Raspatorium und Mucotom Fibula raspatory and mucotome Legra para fibula y mucotomo Fibula rugine et mucotome Fibula periostotomo e mucotomo	128 - 129
C05	Mikromotoren-System und Chirurgische Handstücke Micro motor system and surgical hand pieces Sistema de micromotor y piezas de mano quirúrgicas Système de micromoteur et pièces à main chirurgicales Sistema micromotore e manipoli chirurgici	130 - 131
C06	Winkelschraubendreher Angular screwdrivers Destornilladores de ángulo Tournevis angulaire Cacciaviti angolati	132 - 133
C07	Mikro-Sägen Micro saws Micro sierras Micro scies Micro seghe	134 - 139

D**Siebvorschläge
Set Suggestions
Proposiciones de juegos
Propositions pour boîtes
Proposte di sets**

D01	Rhinoplastik Rhinoplasty Rinoplastia Rhinoplastie Rinoplastica	144 - 147
D02	Lidkorrektur Eyelid correction Corrección de párpados Correction des paupières Chirurgia delle palpebre	148 - 149
D03	Lipofilling Lipofilling Lipofilling Lipofilling Lipofilling	150 - 151
D04	Mikrochirurgischer Gaumenverschluss Microsurgical palate closure Cierre del paladar con microcirugía Fermeture microchirurgicale du palais Chiusura microchirurgica del palato	152 - 153
D05	Lippen-, Kiefer- und Gaumenspalten Lip, jaw and palate fissures Fisuras palatinas, labiales y maxilares Fentes labiales, maxillaires et palatines Labio-palatoschisi	154 - 157
D06	Spongiosaentnahme aus dem Beckenkamm Removal of spongiosa from the iliac crest Extracción de sustancia esponjosa de la cresta iliaca „Cristaca“ Prélèvement d'os spongieux sur la crête iliaque Prelievo di spongiosa dalla cresta iliaca	158 - 159
D07	Spongiosaentnahme aus dem Beckenkamm Removal of spongiosa from the iliac crest Extracción de sustancia esponjosa de la cresta iliaca “Shepard” Prélèvement d'os spongieux sur la crête iliaque Prelievo di spongiosa dalla cresta iliaca	160 - 161
D08	Dysgnathie Dysgnathia Disgnatia Dysgnathie Disgnatia	162 - 167
D09	Frakturbehandlung Fracture treatment Tratamiento de fracturas Traitement des fractures Trattamento di frattura	168 - 171
D10	Orbitarekonstruktion Orbital reconstruction Reconstrucción de la cavidad orbitaria Reconstruction orbitale Ricostruzione dell'orbita	172 - 173
D11	Sinuslifting Sinuslifting Sinuslifting Lifting des sinus Sinuslifting	174 - 175
D12	Weichteilbehandlung Soft tissue therapy Tratamiento de tejido blando Traitement des parties molles Trattamento dei tessuti molli	176 - 179

E

Alphabetischer und numerischer Index Alphabetical and Numerical Index Índice alfabético y numérico Index alphabétique et numérique Indice alfabetico e numerico

E01	Alphabetischer Index Alphabetical Index Índice alfabético Index alphabétique Indice alfabetico	Deutsch	182 - 187
E02	Alphabetischer Index Alphabetical Index Índice alfabético Index alphabétique Indice alfabetico	English	188 - 193
E03	Alphabetischer Index Alphabetical Index Índice alfabético Index alphabétique Indice alfabetico	Español	194 - 198
E04	Alphabetischer Index Alphabetical Index Índice alfabético Index alphabétique Indice alfabetico	Français	199 - 203
E05	Alphabetischer Index Alphabetical Index Índice alfabético Index alphabétique Indice alfabetico	Italiano	204 - 208
E06	Numerischer Index Numerical Index Índice numérico Index numérique Indice numerico		212 - 216



Unsere Instrumenten-Abbildungen haben eine Größe von ca. 50 %. Andere Darstellungsgrößen werden im Maßstab (zum Beispiel 1:1) angegeben. Die dazugehörigen Detailbilder sind in Originalgröße (100 %) abgebildet. Die angegebenen Bemaßungen unterliegen herstellungsbedingt einer Fertigungstoleranz.

In general the instrument illustrations are scaled to be approximately 50 % of actual size. If other scales are used they are indicated (for example 1:1). The corresponding detailed tip illustrations are shown in actual size (100 %). The stated measurements may have a slight variation in permissible tolerances due to minor variations in manufacturing conditions.

Las ilustraciones de los instrumentos tienen un tamaño de aprox. 50 %. Otros tamaños de las ilustraciones serán indicados con la indicación de un escala (por ejemplo 1:1). Los imagenes detallados pertinentes son en su tamaño original (100 %). Las dimensiones indicadas son sujeto de tolerancias.

Nos illustrations d'instruments sont a 50 % de la taille réelle. D'autres dimensions de représentation sont données avec indication d'échelle (par exemple 1:1). Les images de détail sont projetées en grandeur réelle (100 %). Toutes les dimensions données ont une tolérance de fabrication.

Le illustrazioni dei nostri strumenti hanno una dimensione del 50 %. Altre dimensioni di raffigurazione sono segnate con una scala (per esempio 1:1). Le relative illustrazioni dettagliate sono illustrate in dimensioni originali (100 %). Le dimensioni indicate sono soggette a una tolleranza di fabbricazione.

Beispiel
Example
Ejemplo
Exemple
Esempio

Vorderansicht (Schere gerade)
Front view (straight scissors)
Vista frontal (tijera recta)
Vue de face (ciseaux droits)
Vista frontale (forbice retta)

Seitenansicht (Schere gebogen)
Lateral view (curved scissors)
Vista lateral (tijera curva)
Vue laterale (ciseaux courbes)
Vista laterale (forbice curva)

1:1

Darstellungsgröße
Image sizes
Tamaño de representación
Dimension de représentation
Dimensione di raffigurazione

Instrumentengröße
Instrument size
Tamaño del instrumento
Taille des instruments
Dimensione degli strumenti

14 cm - 5½"	14 cm - 5½"	
03.50.14	03.51.14	standard
203.50.14	203.51.14	supercut
213.50.14	213.51.14	blackline
03.50.64	03.51.64	"HM"
203.50.64	202.51.64	supercut plus
223.50.64	222.51.64	magiccut

Artikelnummer
Item number
Número de artículo
Numéro d'article
Codice

Mayo

MEDICON

instruments

OMF SURGERY



BASIC INSTRUMENTS





Skalpellklingen und Skalpellgriffe
Scalpel Blades and Scalpel Handles
Hojas de bisturí y mangos de bisturí
Lames de bistouris et manches pour bistouris
Lame per bisturi e manici per bisturi

1:1

STERILE



Fig. 10 **01.22.10** P₁₀₀



Fig. 11 **01.22.11** P₁₀₀



Fig. 12 **01.22.12** P₁₀₀



Fig. 15 **01.22.15** P₁₀₀

Verpackung für Skalpellklingen
 Packing for scalpel blades
 Paquete para hojas de bisturí
 Emballage pour lames de bistouris
 Confezione per bisturi



12,5 cm – 5" **01.27.03** no. 3



12,0 cm – 4¾" **01.27.17** no. 7K



16,5 cm – 6½" **01.27.07** no. 7



15,5 cm – 6⅛" **01.27.40**



15,5 cm – 6⅛" **01.30.38** **Blake**



21,0 cm – 8¼" **01.27.13** no. 3L

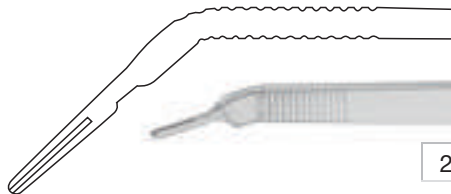

20,5 cm – 8" **01.27.23** no. 3LA



Einmalprodukt
 Single use product
 Prodotto para un solo uso
 Produit à usage unique
 Prodotto monouso

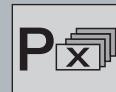

Verpackungseinheit "X" Stück
 Packing unit "X" pieces
 Paquete de "X" unidades
 Emballage de "X" pièces
 Confezione da "X" pezzi

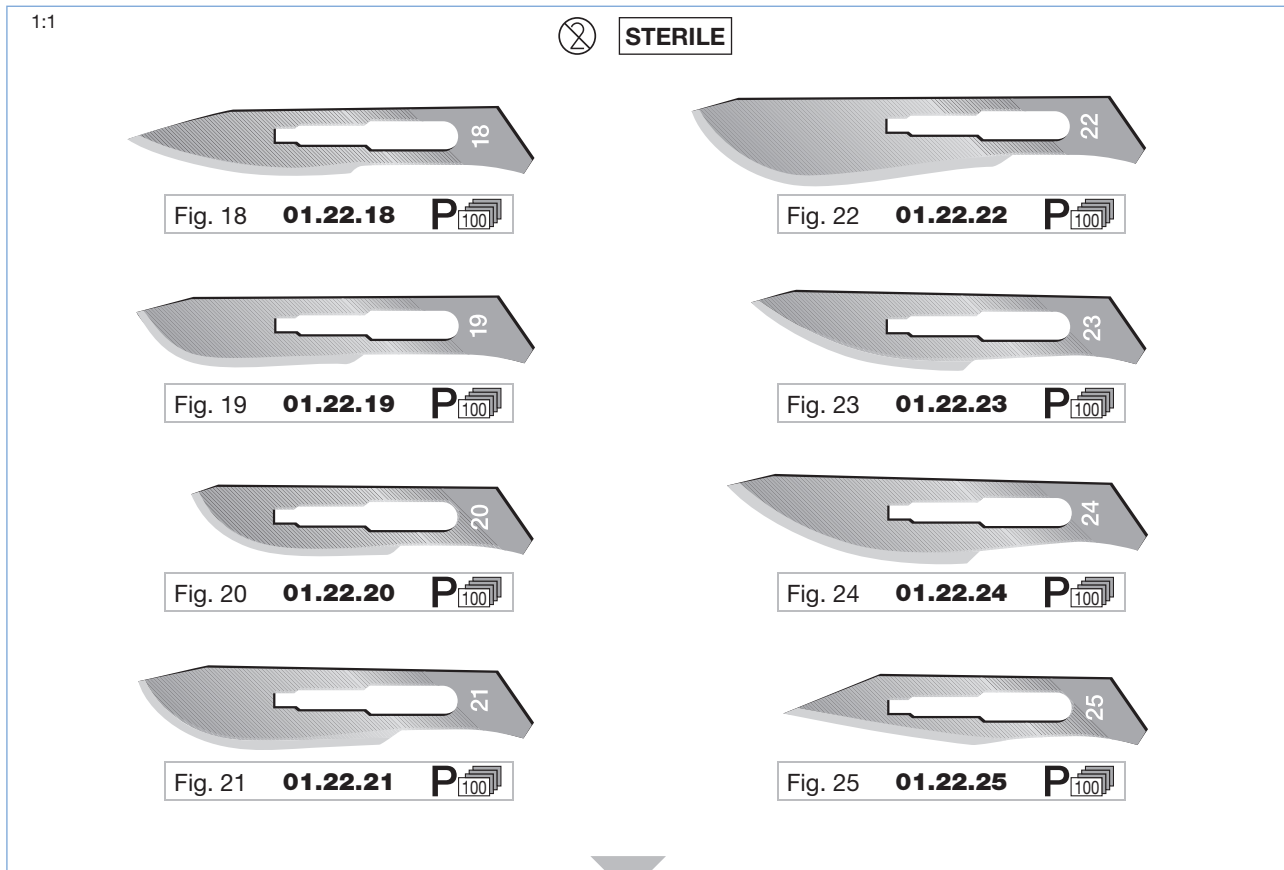

Verpackung für Skalpellklingen
 Packing for scalpel blades
 Paquete para hojas de bisturí
 Emballage pour lames de bistouris
 Confezione per bisturi



13,5 cm – 5³/₈" **01.28.04** no. 4



21,0 cm – 8¹/₄" **01.28.14** no. 4L

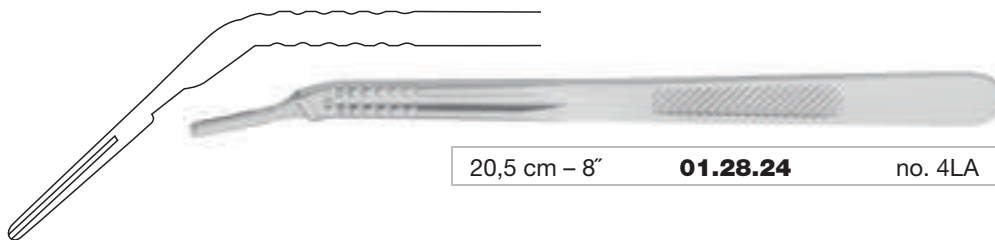

20,5 cm – 8" **01.28.24** no. 4LA



Einmalprodukt
 Single use product
 Prodotto para un solo uso
 Produit à usage unique
 Prodotto monouso



Verpackungseinheit "X" Stück
 Packing unit "X" pieces
 Paquete de "X" unidades
 Emballage de "X" pièces
 Confezione da "X" pezzi



Skalpellsklingen und Skalpellsgriffe
Scalpel Blades and Scalpel Handles
Hojas de bisturí y mangos de bisturí
Lames de bistouris et manches pour bistouris
Lame per bisturi e manici per bisturi

1:1



STERILE



Fig. 65 **01.30.65** P



Fig. 67 **01.30.67** P



13,0 cm – 5 1/8" **01.30.32**

15,5 cm – 6 1/8" **01.30.36**



450.00.03

Unser komplettes Skalpells-Programm finden Sie in unserem Hauptkatalog.
 For our complete scalpels line, see our main catalogue.
 El programa completo de bisturíes se encuentra en nuestro catálogo general.
 Vous trouverez notre programme complet des bistouris dans notre catalogue général.
 Troverete il nostro programma completo di bisturi nel nostro catalogo generale.

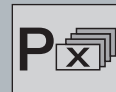

SCISSORS

Von "standard" bis "magic cut" – alle Scheren werden von fachkundigen Chirurgiemechanikern hergestellt, für dauerhafte Leistung sorgfältig gehärtet und qualitätsgerecht geprüft. Die besonderen Eigenschaften unserer Sondermodelle sind auf den Folgeseiten dargestellt.

Starting with "standard" up to "magic cut" – all scissors are manufactured by experienced professionals. They are thoroughly hardened to ensure a long-lasting performance and are quality-checked. The specific characteristics of our special models are explained on the following pages.

Desde tijeras "standard" hasta "magic cut" – todas las tijeras son fabricadas por expertos competentes. Las tijeras son templadas e investigadas respecto a la calidad para un durable rendimiento. Las características de los modelos especiales son mencionadas en las paginas siguientes.

De "standard" à "magic cut" – tous les ciseaux sont fabriqués par des mécaniciens de chirurgie compétents, sont trempés soigneusement afin d'obtenir une performance durable et passent un contrôle de qualité. Les caractéristiques particulières de nos modèles spéciaux sont décrites sur les pages suivantes.

Dalla "standard" alla "magic cut" – tutte le forbici sono prodotte da meccanici chirurgici specializzati. Per una lunga durata sono temprate accuratamente e devono passare il controllo di qualità. Sulle prossime pagine sono illustrate le particolarità dei nostri modelli esclusivi.

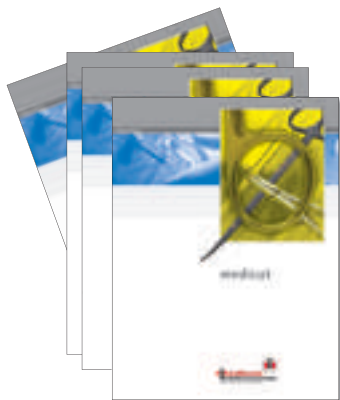

451.03.23

Unser komplettes Scheren-Programm finden Sie in unserem Sonderprospekt.
For our complete scissors line, see our special brochure.

El programa completo de tijeras se encuentra en nuestro folleto especial.

Vous trouverez notre programme complet des ciseaux dans notre prospectus spécial.
Troverete il nostro programma completo di forbici nel nostro depliant speciale.



supercut

Goldene Schraube
Golden screw
Tornillo dorado
Vis dorée
Vite dorata



black line

Goldene Schraube und schwarze Ringgriffe
Golden screw and black rings
Tornillo dorado y anillos negros
Vis dorée et anneaux noirs
Vite dorata e anelli neri



"HM"

Goldene Ringgriffe
Golden rings
Anillos dorados
Anneaux dorés
Anelli dorati



supercut plus

Goldene Schraube und goldene Ringgriffe
Golden screw and golden rings
Tornillo dorado y anillos dorados
Vis dorée et anneaux dorés
Vite dorata e anelli dorati



magic cut

Keramikbeschichtung und goldene Schraube
Ceramic coating and golden screw
Recubrimiento de cerámica y tornillo dorado
Couche céramique et vis dorée
Rivestimento di ceramica e vite dorata





Messerschleiff und Mikroverzahnung: Feiner, minimal traumatisierender Schnitt
Knife edges and micro serration: Fine, minimally traumatizing cut
Hoja de bisturí y dentadura micro: Corte fino, mínimo traumatizante
Aiguisement tranchant et dents micro: Coupe fine, peu traumatisante
Affilatura a scalpello e dentellatura micro: Taglio fine, minimo traumatizzante

Zusätzlicher Anschlag einer Blattrückseite: Bessere Sicht · Präzise Präparation
Reduction of the transversal cut: Better visibility · Precise dissection
Reducción del corte transversal: Vista mejorada · Disección precisa
Coupe transversale réduite: Vue améliorée · Dissection précise
Riduzione del taglio trasversale: Vista migliorata · Dissezione precisa

Eingeschweißte Hartmetallschneiden: Nahtlose, homogene und korrosionsfreie Verbindung von Hartmetall und Scherenstahl

Welded tungsten carbide cutting edges: Seamless, homogenous and corrosion-free junction of tungsten carbide and scissors steel

Hojas soldadas de carburo de tungsteno: Unión sin costuras, homogénea y resistente a la corrosión del carburo de tungsteno con el acero

Lames soudées d'un alliage de carbure de tungstène: Jointure sans trace, homogène et résistante à la corrosion du carbure de tungstène avec l'acier des ciseaux

Lame saldate al carburo di tungsteno: Congiunzione omogenea del carburo di tungsteno con l'acciaio delle forbici senza saldatura e resistente alla corrosione

Keramikbeschichtung: Lange Standzeit · Hohe Oberflächenhärte · Blendfreie Oberfläche · Hervorragende Gleitfähigkeit

Ceramic coating: Long lasting cutting ability · High surface hardness · Non-dazzling surface · Excellent sliding capacity

Recubrimiento de cerámica: Máxima duración del corte · Alta dureza de la superficie · Superficie antideslumbrante · Deslizamiento destacado

Couche céramique: Longue durée de vie · Grande dureté de la surface · Surface non-éblouissante · Glissement excellent

Rivestimento di ceramica: Massima durata del taglio · Alta durezza della superficie · Superficie antiriflesso · Eccellente scorrimento



Feine Scheren
 Delicate scissors
 Tijeras finas
 Ciseaux délicats
 Forbici delicate



Wagner

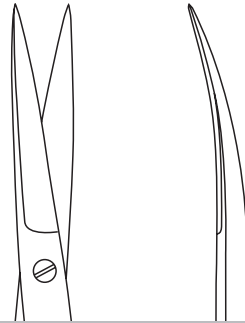

12 cm – 4¾"	12 cm – 4¾"	
02.06.12	02.07.12	standard

Feine Scheren
 Delicate scissors
 Tijeras finas
 Ciseaux délicats
 Forbici delicate

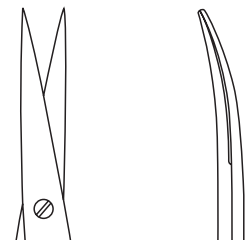

12 cm – 4¾"	12 cm – 4¾"	
02.26.12	02.27.12	standard

Feine Präparierscheren
 Delicate dissecting scissors
 Tijeras finas para disección
 Ciseaux délicats pour dissection
 Forbici delicate per dissezione

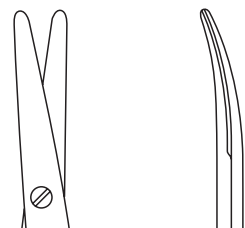

12 cm – 4¾"	12 cm – 4¾"	
02.40.12	02.41.12	standard
202.40.12	202.41.12	supercut
212.40.12	212.41.12	black line
02.40.62	02.41.62	"HM"
202.40.62	202.41.62	supercut plus
222.40.62	222.41.62	magic cut





16 cm - 6¼"
04.83.17
 standard

Locklin



16 cm - 6¼"
04.83.27
 standard

Locklin

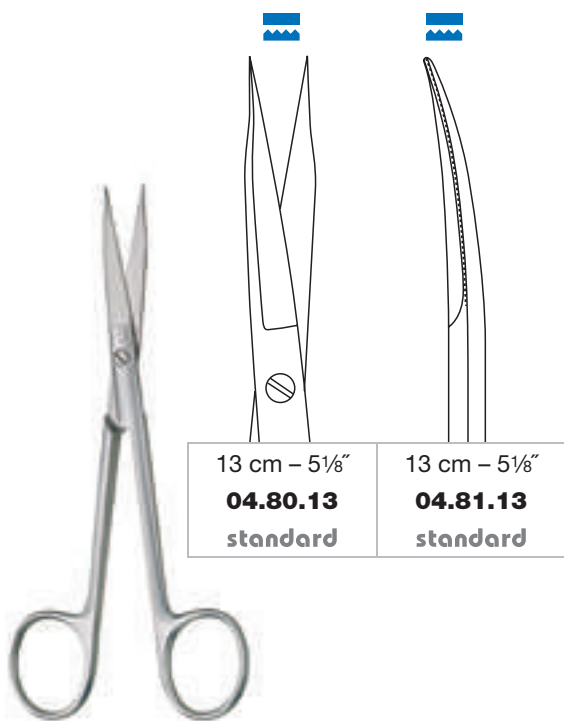

13 cm - 5⅛"
04.80.13
 standard

13 cm - 5⅛"
04.81.13
 standard

Fox

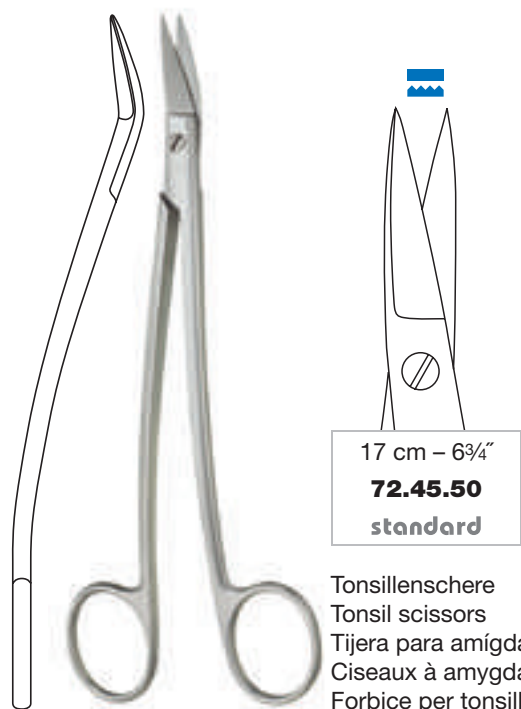

17 cm - 6¾"
72.45.50
 standard

Dean

Tonsillenschere
 Tonsil scissors
 Tijera para amígdalas
 Ciseaux à amygdales
 Forbice per tonsille



14,5 cm – 5¾"	14,5 cm – 5¾"	
03.02.14	03.03.14	standard
203.02.14	203.03.14	supercut
213.02.14	213.03.14	black line
03.02.64	03.03.64	"HM"

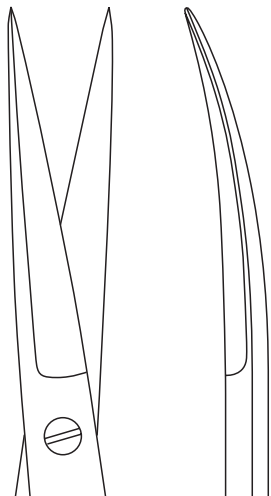

14,5 cm – 5¾"	14,5 cm – 5¾"	
03.04.14	03.05.14	standard
203.04.14	203.05.14	supercut
213.04.14	213.05.14	black line
03.04.64	03.05.64	"HM"

Chirurgische Scheren
 Operating scissors
 Tijeras quirúrgicas
 Ciseaux chirurgicaux
 Forbici chirurgiche



14,5 cm – 5¾"	14,5 cm – 5¾"	
03.06.14	03.07.14	standard
203.06.14	203.07.14	supercut
213.06.14	213.07.14	black line
03.06.64	03.07.64	"HM"

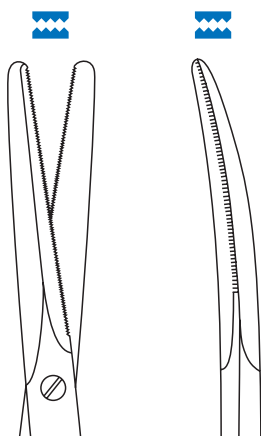

14 cm – 5½"	14 cm – 5½"
02.70.14	02.71.14
standard	standard

Beuse

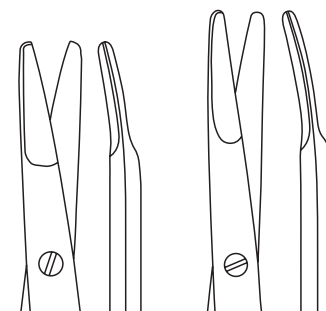

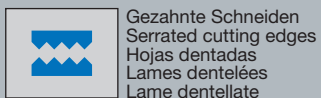

13 cm – 5⅛"	15 cm – 6"
04.13.13	04.13.15
standard	standard

Ragnell (Kilner)





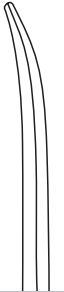

Feine Präparierscheren
Delicate Dissecting Scissors
Tijeras finas para disección
Ciseaux délicats pour dissection
Forbici delicate per dissezione



11,5 cm – 4½"	11,5 cm – 4½"
04.32.11	04.33.11
standard	standard

Baby-Metzenbaum



15 cm – 6"	15 cm – 6"
04.50.15	04.51.15
standard	standard

Joseph

16 cm – 6¼"	16 cm – 6¼"
04.54.16	04.55.16
standard	standard

Kelly

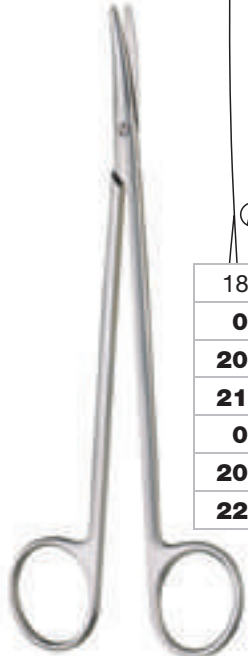
Präparierscheren
 Dissecting scissors
 Tijeras para disección
 Ciseaux pour dissection
 Forbici per dissezione

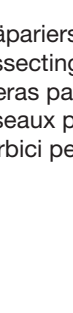
18 cm – 7⅛"	
04.63.18	standard
204.63.18	supercut
214.63.18	black line
04.63.68	"HM"
204.63.68	supercut plus
224.63.68	magic cut

Toennis-Adson





Metzenbaum-slim

14 cm – 5½"	18 cm – 7⅛"	20 cm – 8"	
04.34.14	04.34.18	04.34.20	standard
204.34.14	204.34.18	204.34.20	supercut
214.34.14	214.34.18	214.34.20	black line
04.34.64	04.34.68	04.34.70	"HM"
204.34.64	204.34.68	204.34.70	supercut plus



Metzenbaum-slim

14 cm – 5½"	18 cm – 7⅛"	20 cm – 8"	
04.35.14	04.35.18	04.35.20	standard
204.35.14	204.35.18	204.35.20	supercut
214.35.14	214.35.18	214.35.20	black line
04.35.64	04.35.68	04.35.70	"HM"
204.35.64	204.35.68	204.35.70	supercut plus
224.35.64	224.35.68	224.35.70	magic cut



Mayo-Style



15 cm – 6"	15 cm – 6"	
03.56.15	03.57.15	standard
203.56.15	203.57.15	supercut
213.56.15	213.57.15	black line
03.56.65	03.57.65	"HM"
203.56.65	203.57.65	supercut plus
223.56.65	223.57.65	magic cut



Mayo

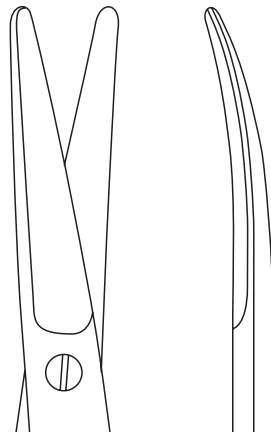

14 cm – 5½"	14 cm – 5½"	
03.50.14	03.51.14	standard
203.50.14	203.51.14	supercut
213.50.14	213.51.14	black line
03.50.64	03.51.64	"HM"
203.50.64	203.51.64	supercut plus
223.50.64	223.51.64	magic cut

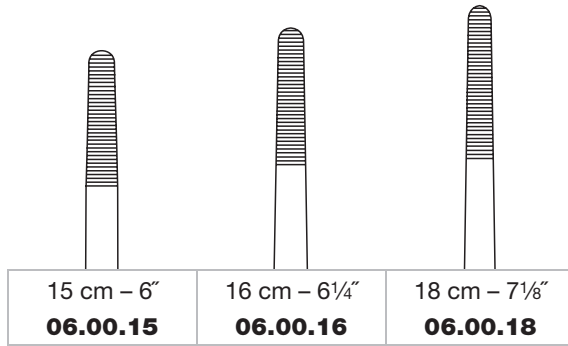
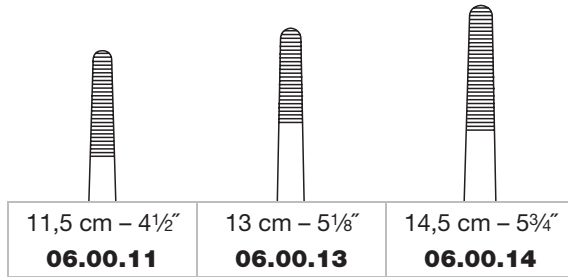

schlank
 slim
 delgada
 élancée
 stretta

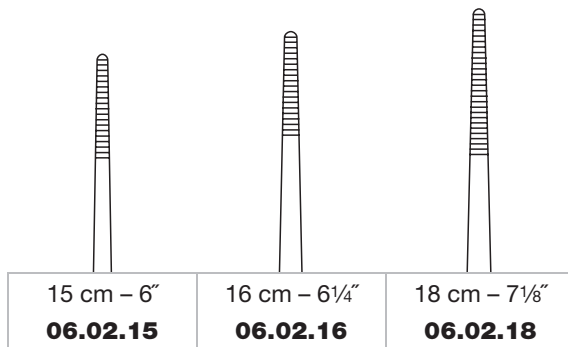
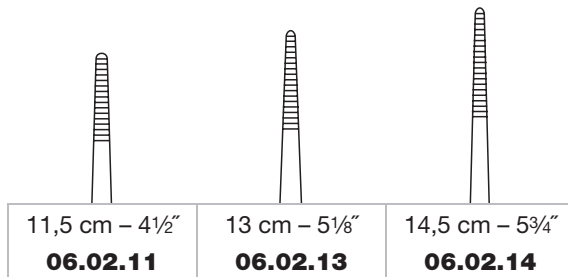



Anatomische Pinzetten
Dressing Forceps
Pinzas anatómicas
Pinces anatomiques
Pinze anatomiche



Potts-Smith "HM"

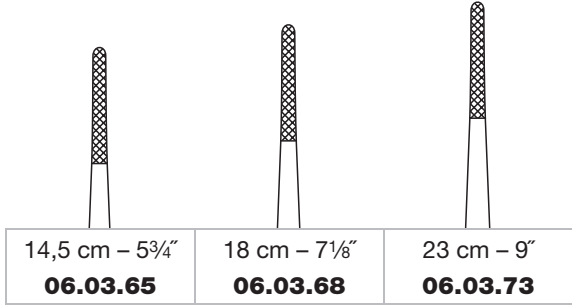

McIndoe

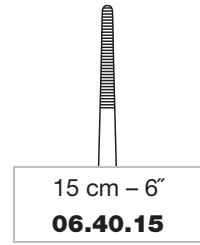

Adson

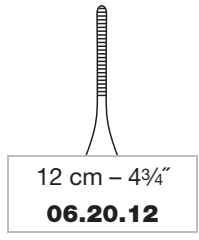

Adson "HM"

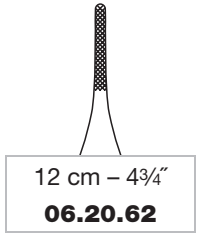

"HM"
 Hartmetall
 Tungsten carbide
 Carburo de tungsteno
 Carbure de tungstène
 Carburo di tungsteno

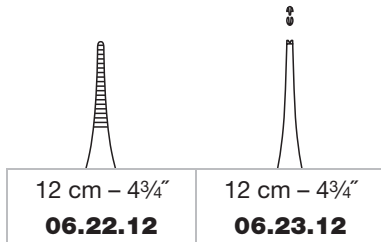

Micro-Adson

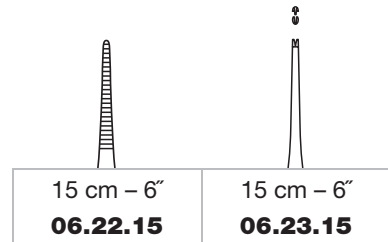

Micro-Adson

Bajonettpinzette
 Bayonet forceps
 Pinza en forma bayoneta
 Pince en forme baïonette
 Pinza a forma di baionetta

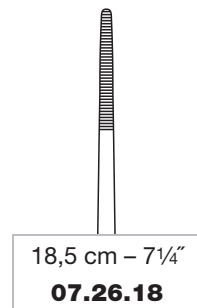

90 mm

Cushing (Taylor)

mit Dissektorende
 with dissector end
 con extremo sirviendo de legra
 avec extrémité dissecteur
 con la parte finale a forma di dissettore





Anatomische und chirurgische Pinzetten
Dressing and Tissue Forceps
Pinzas anatómicas y quirúrgicas
Pinces anatomiques et chirurgicales
Pinze anatomiche e chirurgiche

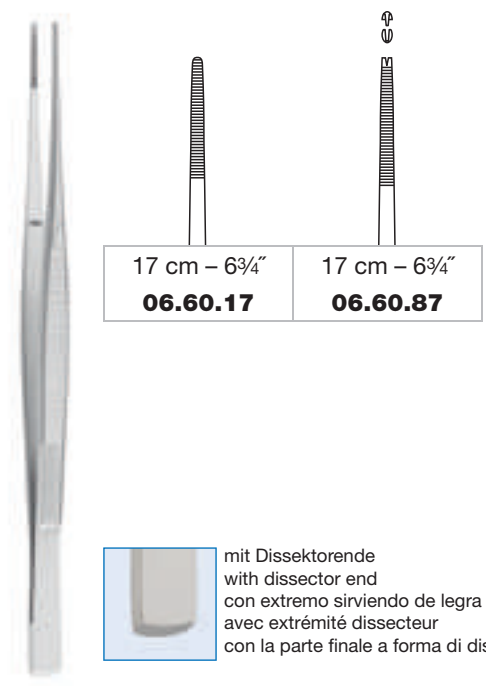

mit Dissektorende
 with dissector end
 con extremo sirviendo de legra
 avec extrémité dissecteur
 con la parte finale a forma di dissettore

Cushing

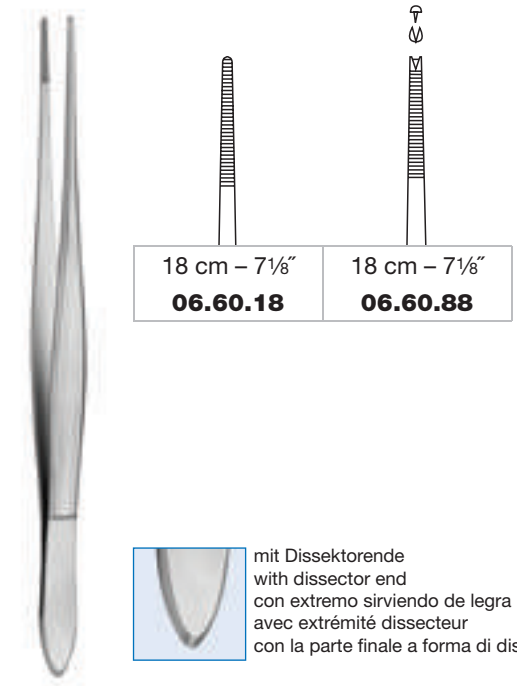

mit Dissektorende
 with dissector end
 con extremo sirviendo de legra
 avec extrémité dissecteur
 con la parte finale a forma di dissettore

Cushing

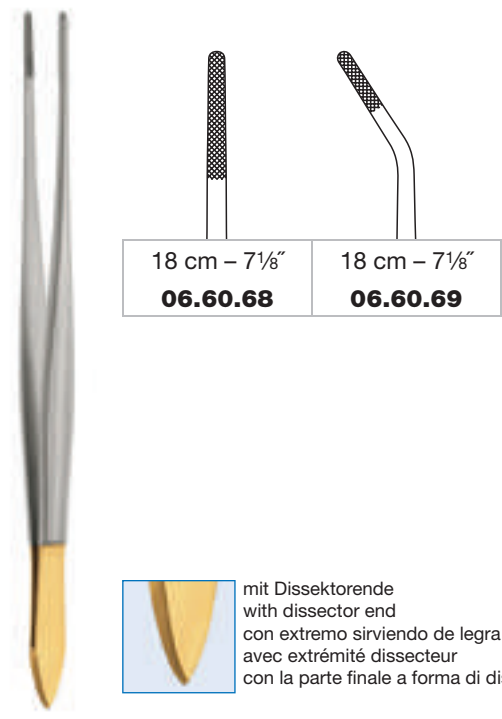

mit Dissektorende
 with dissector end
 con extremo sirviendo de legra
 avec extrémité dissecteur
 con la parte finale a forma di dissettore



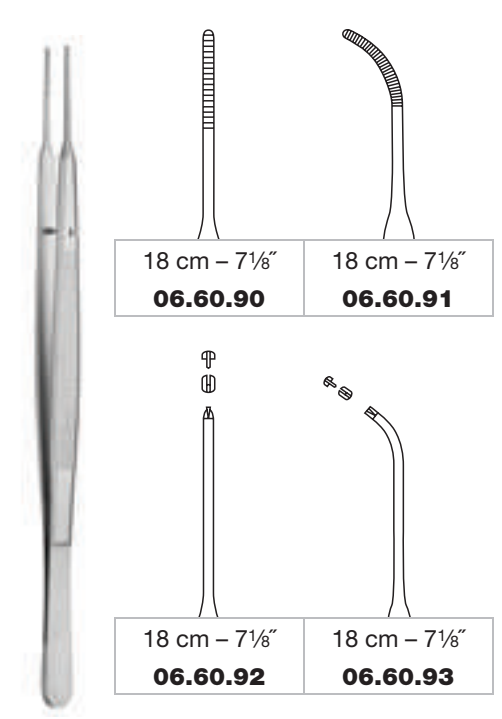

Cushing "HM"







Gerald



"HM"
 Hartmetall
 Tungsten carbide
 Carburo de tungsteno
 Carbure de tungstène
 Carburo di tungsteno



				
13 cm – 5 1/8"	14,5 cm – 5 3/4"	16 cm – 6 1/4"	18 cm – 7 1/8"	20 cm – 8"
06.10.13	06.10.14	06.10.16	06.10.18	06.10.20

			
13 cm – 5 1/8"	14,5 cm – 5 3/4"	16 cm – 6 1/4"	20 cm – 8"
06.11.13	06.11.14	06.11.16	06.11.20



	
14,5 cm – 5 3/4"	16 cm – 6 1/4"
06.11.84	06.11.86

15 cm – 6"
06.40.85

Gillies



Gewebefasspinzetten und Mikro-Pinzetten
Tissue Grasping Forceps and Micro Forceps
Pinzas para agarrar tejidos y micro pinzas
Pinces pour saisir le tissu et micro pinces
Pinze per afferrare tessuti e micro pinze



Brown

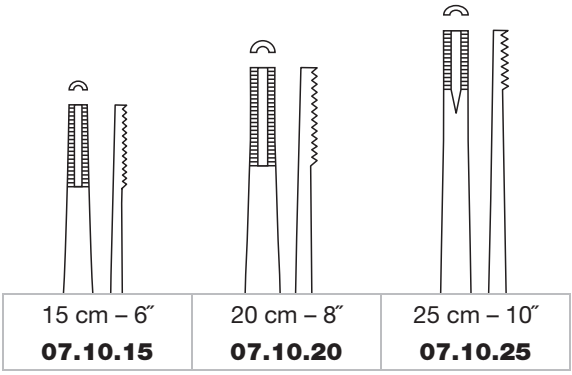

Lidfasspinzette
 Lid grasping forceps
 Pinza para agarrar párpados
 Pince à saisir les paupières
 Pinza per afferrare palpebre



Walter

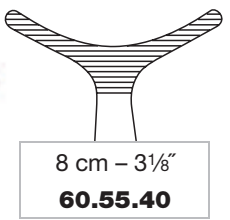

micro 2000

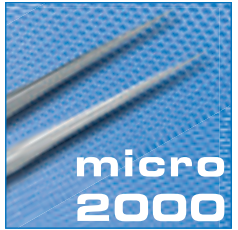
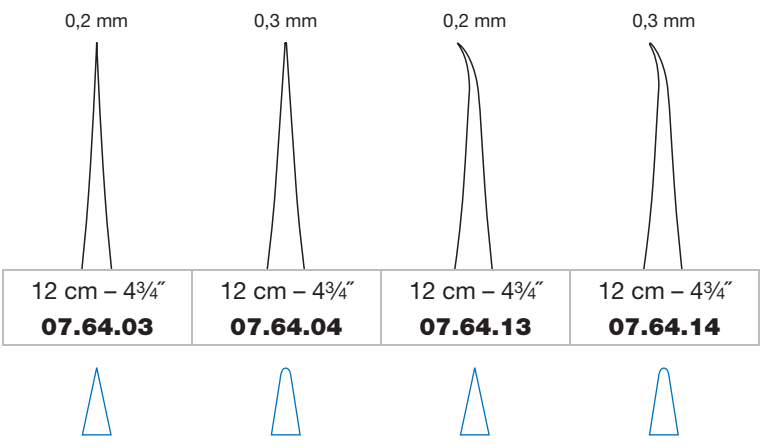

- geringes Gewicht
- gut ausbalanciert
- ermüdungsfreies Arbeiten
- extremely light weight
- well balanced
- fatigueless working
- peso muy ligero
- bien equilibrado
- trabajo sin fatiga
- poids léger
- bien équilibrés
- travail sans fatigue
- peso minimo
- equilibrio perfetto
- non affaticano la mano



spitz
sharp
aguda
pointu
acuta



stumpf
blunt
roma
mousse
smussa



Antihftbeschichtung sorgt für eine effektive Koagulation
Anti-stick coating assures an effective coagulation
El recubrimiento no adherente permite una coagulación efectiva
Grâce à ses pointes anti-adhésives, la pince bipolaire permet une meilleure coagulation
Il rivestimento antiaderente permette una coagulazione effettiva



- ▶ Kein Anhaften von Biogewebe
- ▶ Schnelle Wärme- und Stromableitung
- ▶ Einfache Reinigung

- ▶ No adhesion of biological tissue
- ▶ Quick discharge of heat and current
- ▶ Easy to clean

- ▶ Ninguna adherencia del tejido
- ▶ Derivación rápida del calor y corriente
- ▶ Mantenimiento fácil

- ▶ Les tissus ne restent pas collés à la pince
- ▶ Conductivité rapide et sûre de la chaleur et de l'électricité
- ▶ Entretien facile

- ▶ Nessuna adesione di tessuti
- ▶ Derivazione veloce di calore e corrente
- ▶ Pulizia facile



Bipolare Antihaft-Pinzetten
Bipolar Non-sticking Forceps
Pinzas bipolares no adherentes
Pinces bipolaires anti-adhésives
Pinze bipolarari antiaderenti

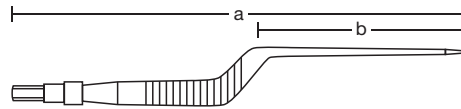

1:1.5



a = 15 cm – 6"	88.07.02		0,6 mm
a = 15 cm – 6"	88.07.03		1,0 mm
a = 18 cm – 7 1/8"	88.07.07		0,6 mm
a = 18 cm – 7 1/8"	88.07.08		1,0 mm
a = 20 cm – 8"	88.07.12		0,6 mm
a = 20 cm – 8"	88.07.13		1,0 mm

1:1.5



a = 20 cm – 8"	b = 10 cm – 4"	88.08.01		0,3 mm
a = 20 cm – 8"	b = 10 cm – 4"	88.08.02		0,6 mm
a = 20 cm – 8"	b = 10 cm – 4"	88.08.03		1,0 mm
a = 20 cm – 8"	b = 10 cm – 4"	88.08.04		1,3 mm
a = 20 cm – 8"	b = 10 cm – 4"	88.08.05		2,0 mm
a = 22 cm – 8 3/4"	b = 13 cm – 5 1/8"	88.08.06		0,3 mm
a = 22 cm – 8 3/4"	b = 13 cm – 5 1/8"	88.08.07		0,6 mm
a = 22 cm – 8 3/4"	b = 13 cm – 5 1/8"	88.08.08		1,0 mm
a = 22 cm – 8 3/4"	b = 13 cm – 5 1/8"	88.08.09		1,3 mm
a = 22 cm – 8 3/4"	b = 13 cm – 5 1/8"	88.08.10		2,0 mm
a = 24 cm – 9 1/2"	b = 15 cm – 6"	88.08.11		0,3 mm
a = 24 cm – 9 1/2"	b = 15 cm – 6"	88.08.12		0,6 mm
a = 24 cm – 9 1/2"	b = 15 cm – 6"	88.08.13		1,0 mm
a = 24 cm – 9 1/2"	b = 15 cm – 6"	88.08.14		1,3 mm
a = 24 cm – 9 1/2"	b = 15 cm – 6"	88.08.15		2,0 mm

Stecker für Instrumente: 88.07.02-03
 Connector for instruments: 88.07.07-08
 Enchufe para instrumentos: 88.07.12-13
 Fiche pour instruments: 88.07.12-13
 Attacco per strumenti: 88.08.01-15

Stecker für Geräte von: Connector for apparatus of:
 Enchufe para equipos de: Fiche pour appareils de:
 Attacco per apparecchi:

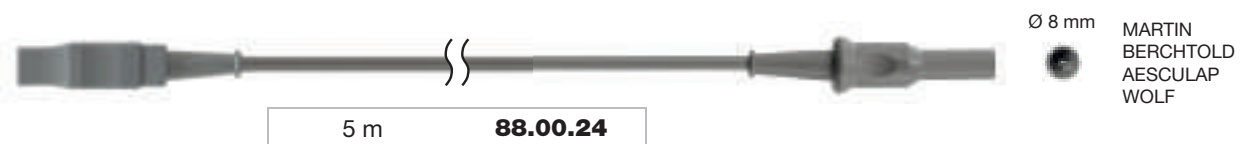
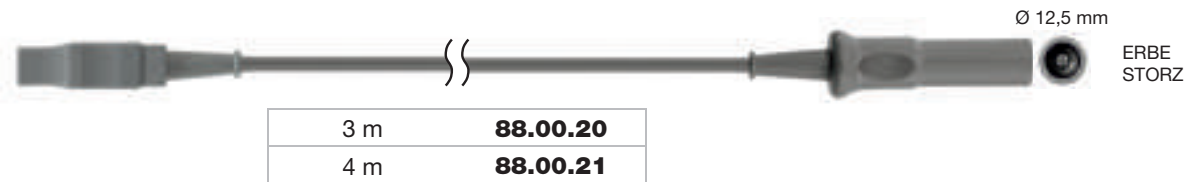

Halteklammer für ein Hochfrequenzkabel mit Knickschutz
 Bracket for one high frequency cable with buckling resistance
 Dispositivo para un cable de alta frecuencia con protección contra pliegues de cables
 Dispositif pour un câble à haut fréquence avec protection contre plis de câble
 Dispositivo per un cavo ad alta frequenza con protezione anti piega

- ▶ Passend für Siebkörbe ab ½-Container
- ▶ Sicherheitsverschluss dient auch als Haltegriff
- ▶ Verwendbar für alle Hochfrequenzkabel
- ▶ Suitable for wire baskets starting from ½ container
- ▶ Safety lock may serve as handle
- ▶ Suitable for all high frequency cables
- ▶ Aptos para bandejas a partir de ½ contenedor
- ▶ Cierre de seguridad sirve también de mango
- ▶ Utilizable para todos cables de alta frecuencia
- ▶ Approprié pour paniers à partir de ½ container
- ▶ Fermoir de sécurité utilisable comme manche
- ▶ Approprié pour tous types de câbles à haut fréquence
- ▶ Adatto a cestelli da ½ contenitore
- ▶ Chiusura di sicurezza utilizzabile come manico
- ▶ Adatto a tutti i cavi ad alta frequenza



22,5 cm - 9" **88.00.40**



“HM”

Nadelhalter mit Hartmetalleinlagen
 Needle holders with tungsten carbide inserts
 Porta-agujas con bocas revestidas de plaquitas de carburo de tungsteno
 Porte-aiguilles avec mors en carbure de tungstène
 Portaghi con placchette di carburo di tungsteno

0,5 mm

für Nadeln und Nahtmaterial bis Stärke 4-0
 for needles and sutures up to size 4-0
 para agujas y material de sutura hasta el espesor de 4-0
 pour aiguilles et matériel à suture jusqu'à une épaisseur de 4-0
 per aghi e materiale per sutura fino ad uno spessore di 4-0

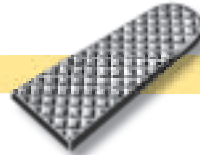

N

normal
 regular
 normal
 normale
 normale

0,4 mm

für feine Nadeln und Nahtmaterial in der Stärke 5-0 und 6-0
 for delicate needles and sutures sizes 5-0 and 6-0
 para agujas finas y material de sutura para espesores 5-0 y 6-0
 pour aiguilles fines et matériel à suture d'une épaisseur de 5-0 et 6-0
 per aghi fini e materiale per sutura fino ad uno spessore di 5-0 e 6-0

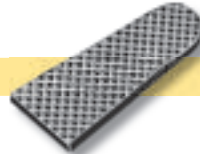

F

fein
 fine
 fino
 fine
 fine

0,3 mm

für Mikro-Nadeln und Nahtmaterial bis Stärke 10-0
 for micro-needles and sutures up to size 10-0
 para micro-agujas y material de sutura hasta el espesor de 10-0
 pour micro-aiguilles et matériel à suture jusqu'à une épaisseur de 10-0
 per aghi micro e materiale per sutura fino ad uno spessore di 10-0

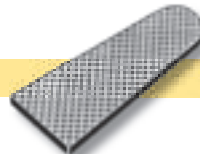

EF

extra-fein
 extra-fine
 extra-fino
 extra-fine
 extra-fine

glatt

für feine Nadeln und Nahtmaterial in der Stärke 7-0 bis 10-0
 for delicate needles and sutures from sizes 7-0 to 10-0
 para agujas finas y material de sutura para espesores 7-0 y 10-0
 pour aiguilles fines et matériel à suture d'une épaisseur de 7-0 à 10-0
 per aghi fini e materiale per sutura fino ad uno spessore di 7-0 fino a 10-0

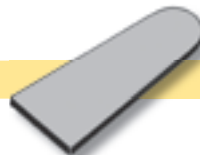

glatt

smooth
 liso
 lisse
 liscia





Mayo-Hegar "HM"

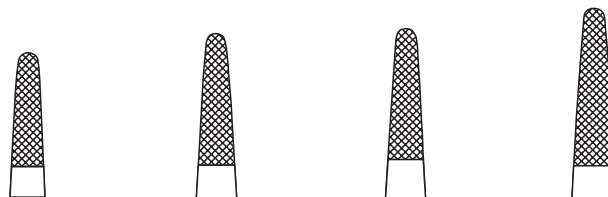

	15 cm – 6"	18 cm – 7 1/8"	20 cm – 8"	23 cm – 9"
N	10.18.65	10.18.68	10.18.70	10.18.73
Ti	10.18.85	10.18.88	10.18.90	10.18.93

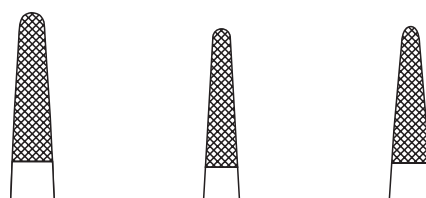

	24 cm – 9 1/2"	26 cm – 10 1/4"	30 cm – 11 3/4"
N	10.18.74	10.18.76	10.18.80



Titanium



Crile-Wood



15 cm – 6"	18 cm – 7 1/8"
10.20.15	10.20.18

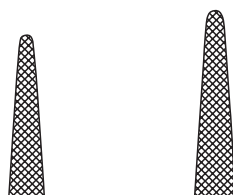

20 cm – 8"	23 cm – 9"
10.20.20	10.20.23



F	15 cm – 6"
	10.20.64



Baby-Crile-Wood "HM"

"HM"

Hartmetall
 Tungsten carbide
 Carburo de tungsteno
 Carbure de tungstène
 Carburo di tungsteno

N

4-0

normal
 regular
 normal
 normale
 normale

F

5-0 and 6-0

fein
 fine
 fino
 fine
 fine



**Crile-Wood "HM"
(DeBakey "HM")**

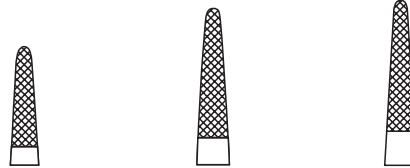

F	15 cm – 6" 10.20.65	18 cm – 7 1/8" 10.20.68	20 cm – 8" 10.20.70
----------	-------------------------------	-----------------------------------	-------------------------------

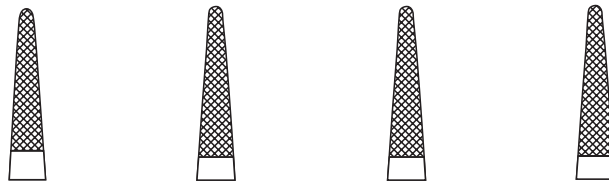

F	23 cm – 9" 10.20.73	25 cm – 10" 10.20.75	26 cm – 10 1/4" 10.20.76	30 cm – 11 3/4" 10.20.80
----------	-------------------------------	--------------------------------	------------------------------------	------------------------------------



Mathieu "HM"

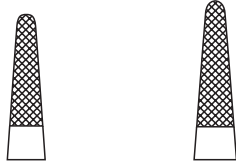

N	14 cm – 5 1/2" 11.22.64	17 cm – 6 3/4" 11.22.67
----------	-----------------------------------	-----------------------------------



N	20 cm – 8" 11.22.70
----------	-------------------------------

mit Schere
with scissors
con tijera
avec ciseaux
con forbice



Gillies "HM"



F	15,5 cm – 6 1/8" 10.59.65
----------	-------------------------------------





Mathieu "HM"

14 cm – 5½"	17 cm – 6¾"	20 cm – 8"	24 cm – 9½"
N 11.20.64	11.20.67	11.20.70	11.20.74



micro-slim "HM"

15 cm – 6"	18 cm – 7¼"	20 cm – 8"	23 cm – 9"
F 10.24.65	10.24.68	10.24.70	10.24.73

15 cm – 6"	18 cm – 7¼"	20 cm – 8"
■ 10.24.66	10.24.69	10.24.71

N
4-0
normal
regular
normal
normale
normale

F
5-0 and 6-0
fein
fine
fino
fine
fine
fine

■
7-0 to 10-0
glatt
smooth
liso
lisse
liscia

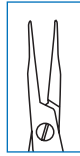

0,4 mm



18 cm – 7 1/8" **12.18.66**



0,4 mm



18 cm – 7 1/8" **12.18.67**



0,5 mm



18 cm – 7 1/8" **12.18.68**



0,5 mm



18 cm – 7 1/8" **12.18.69**



mit Sperre
 with catch
 con cremallera
 avec crémaillère
 con cremagliera



8 mm
 mit Rundgriff
 with round handle
 con mango redondo
 avec manche ronde
 con manico rotondo



micro 2000



18 cm – 7 1/8" **12.18.74**



18 cm – 7 1/8" **12.18.75**



mit Sperre
 with catch
 con cremallera
 avec crémaillère
 con cremagliera



- geringes Gewicht
- gut ausbalanciert
- ermüdungsfreies Arbeiten

- extremely light weight
- well balanced
- fatigueless working

- peso muy ligero
- bien equilibrado
- trabajo sin fatiga

- poids léger
- bien équilibrés
- travail sans fatigue

- peso minimo
- equilibrio perfetto
- non affaticano la mano



mit Diamantbeschichtung
 with diamond dust coating
 con recubrimiento de diamante
 avec couche diamantée
 con rivestimento di diamante

Bulldog-Klemmen
 Bulldog clamps
 Clamps Bulldog
 Clamps Bulldog
 Pinze Bulldog

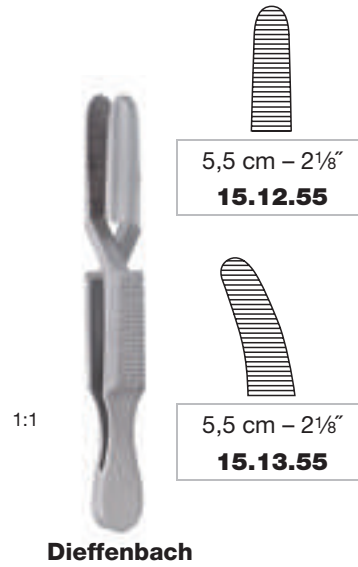
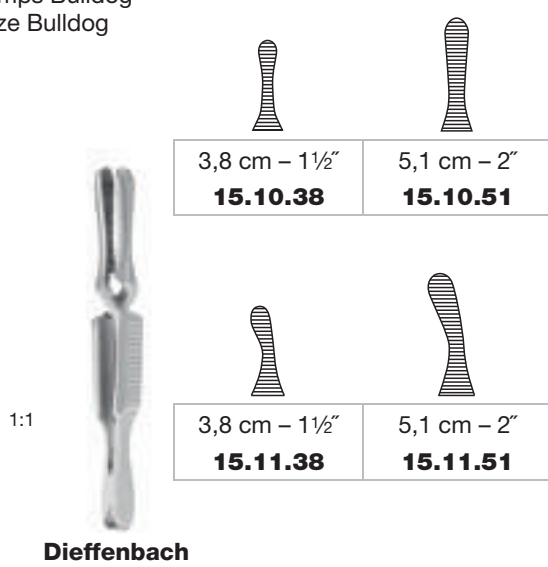

Arterienklemmen
 Hemostatic forceps
 Pinzas hemostáticas
 Pincers hémostatiques
 Pinze emostatiche

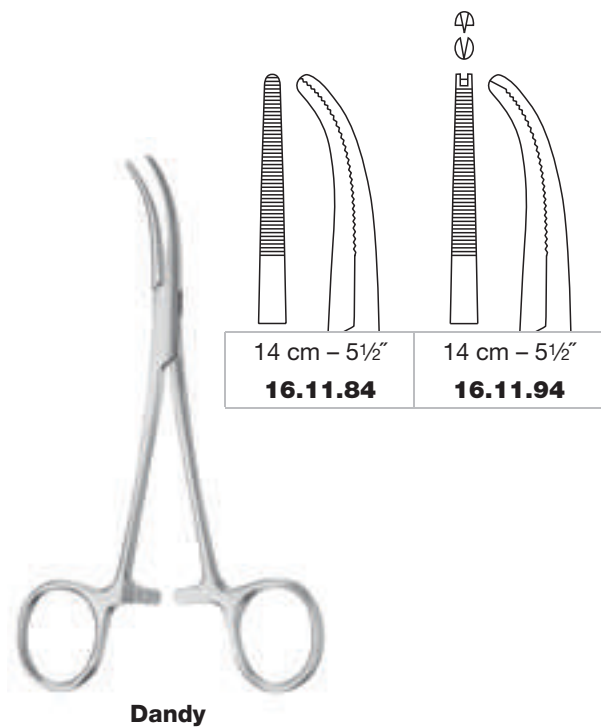
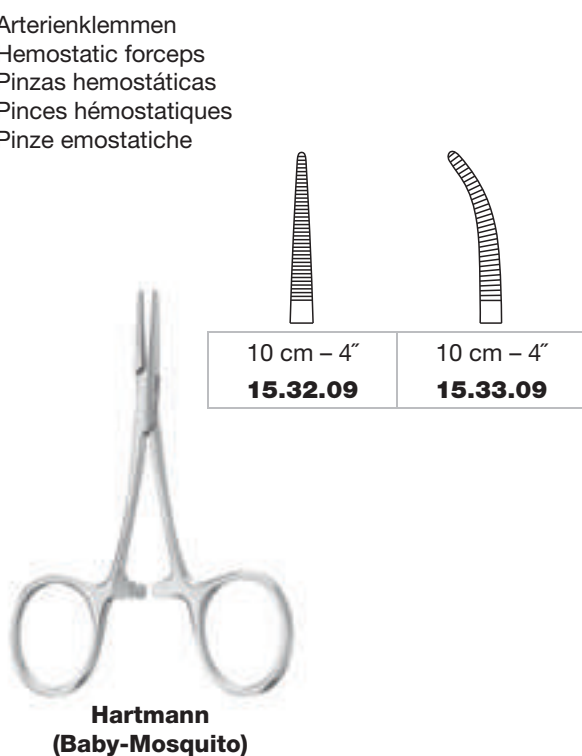



Arterienklemmen
Hemostatic forceps
Pinzas hemostáticas
Pinces hémostatiques
Pinze emostatiche



Halsted-Mosquito



12,5 cm – 5"
15.44.12



12,5 cm – 5"
15.45.12



14 cm – 5½"
15.44.14



14 cm – 5½"
15.45.14



12,5 cm – 5"
15.46.12

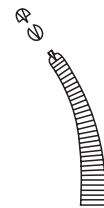

12,5 cm – 5"
15.47.12

Arterienklemmen
Hemostatic forceps
Pinzas hemostáticas
Pinces hémostatiques
Pinze emostatiche



Providence-Hospital



14 cm – 5½"
15.50.14



14 cm – 5½"
15.51.14



Kelly



14 cm – 5½"
15.70.14



14 cm – 5½"
15.71.14



Präparierklemmen
 Dissecting forceps
 Pinzas para disección
 Pincers à dissection
 Pinze per dissezione



Tuchklemme
 Towel clamp
 Pinza de campo
 Pince à champs
 Pinza fissateli



Tuchklemmen
 Towel clamps
 Pinzas de campo
 Pincers à champs
 Pinze fissateli





Tuchklemmen
Towel clamps
Pinzas de campo
Pinces à champs
Pinze fissateli

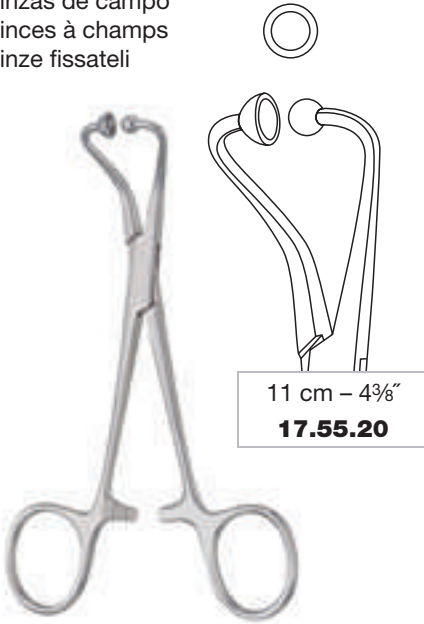

11 cm – 4 $\frac{3}{8}$ "
17.55.20

Backhaus
Ball and Socket

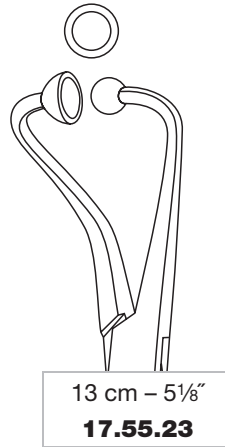

13 cm – 5 $\frac{1}{8}$ "
17.55.23

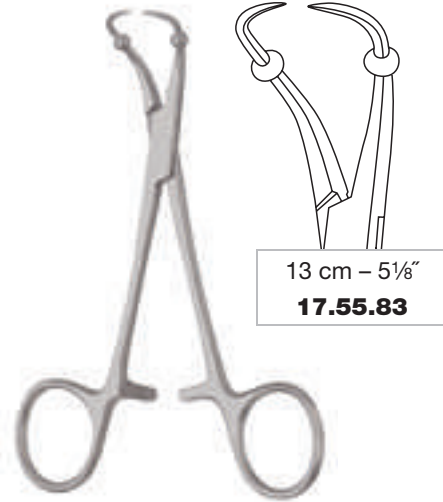

13 cm – 5 $\frac{1}{8}$ "
17.55.83

Backhaus-Roeder



450.00.03

Weitere Medicon-Produkte finden Sie in unserem Hauptkatalog.
You will find further Medicon products in our main catalogue.
Más productos de Medicon se encuentran en nuestro catálogo general.
Vous trouverez d'autres produits Medicon dans notre catalogue général.
Altri prodotti Medicon si trovano nel nostro catalogo generale.





20 cm - 8"
19.14.20

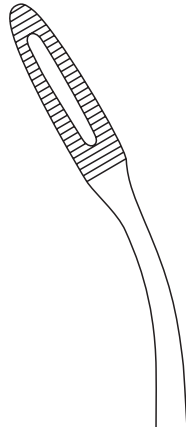

20 cm - 8"
19.15.20

Gross



26 cm - 10 1/4"
19.14.26



26 cm - 10 1/4"
19.15.26

Maier



20 cm - 8"
19.16.20

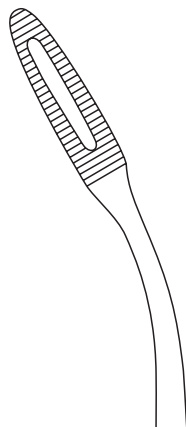

20 cm - 8"
19.17.20

Gross



26 cm - 10 1/4"
19.16.26



26 cm - 10 1/4"
19.17.26

Maier



mit Mandrin
 with guide
 con mandril
 avec mandrin
 con mandrino

L = 125 mm

Charr. 6 **09.83.07**



Stiller

Knopfkanülen
 Cannulas with olive
 Cánulas con oliva
 Canules avec olive
 Cannule con oliva

1:1

L = 80 mm

Ø 1,0 mm	09.79.70
Ø 1,2 mm	09.79.71
Ø 1,4 mm	09.79.72
Ø 1,5 mm	09.79.73
Ø 1,6 mm	09.79.74
Ø 1,8 mm	09.79.75
Ø 2,0 mm	09.79.76



♀ Luer

1:1

L = 80 mm

Ø 1,8 mm **09.79.85**

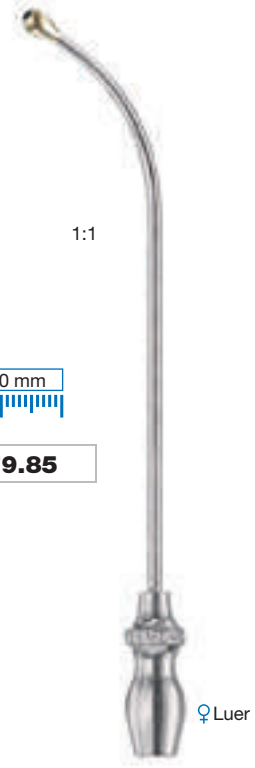

♀ Luer

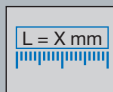

L = X mm

Nutzlänge (Kanüle)
 Working length (cannula)
 Longitud útil (cánula)
 Longueur utile (canule)
 Lunghezza utile (cannula)



mit Mandrin
 with guide
 con mandril
 avec mandrin
 con mandrino



L = 125 mm

Charr. 6	09.83.26
Charr. 8	09.83.28
Charr. 10	09.83.30
Charr. 12	09.83.32
Charr. 15	09.83.34

♀ Luer

Frazier (Fergusson)



mit Mandrin
 with guide
 con mandril
 avec mandrin
 con mandrino

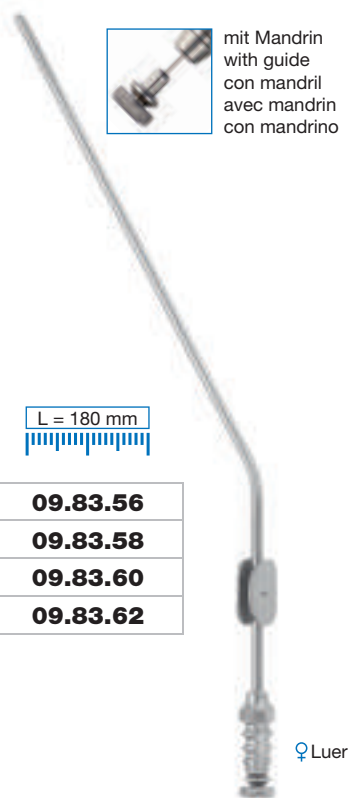

L = 180 mm

Charr. 6	09.83.56
Charr. 8	09.83.58
Charr. 10	09.83.60
Charr. 12	09.83.62

♀ Luer

Frazier

Saugelevatorium
 Suction elevator
 Elevador aspirador
 Elévateur aspirateur
 Elevatore con aspirazione



3 mm

18,5 cm - 7 1/4"
67.15.98

Schlauchansatz, drehbar
 Tube connection, rotatable
 Empalme de tubo, giratorio
 Embout de tuyau, rotatif
 Attacco per tubo, girevole

360°

Haraldsson

Mit drehbarem Schlauchansatz und Bleistiftgriff für komfortables Arbeiten. Die gerundete Spitze verletzt nicht den Knorpel, ermöglicht aber eine präzise, subperichondrale Präparation.

With rotating tube connection and pencil grip for comfortable operation. The rounded tip does not damage the cartilage but enables a precise subperichondrial preparation.

Con empalme de tubo giratorio y mango en forma de lápiz para trabajar de forma más cómoda. La punta redondeada no daña el cartilago, pero permite una disección subpericondral precisa.

Avec embout de tuyau rotatif et manche crayon pour un travail confortable. La pointe arrondie n'endommage pas le cartilage, et permet une préparation sous-périchondrale précise.

Con attacco girevole per tubo girevole e manico a matita per la massima comodità di lavoro. La punta arrotondata non danneggia la cartilagine, ma consente una precisa preparazione subpericondral.

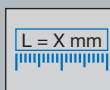

Nutzlänge (Kanüle)
 Working length (cannula)
 Longitud útil (cánula)
 Longueur utile (canule)
 Lunghezza utile (cannula)



Myrtenblattsonden
Myrtle leaf probes
Estiletos hoja de mirto
Stylets feuille de myrte
Specilli a foglia di mirto



1:1

13,0 cm – 5 1/8"	09.08.13	
14,5 cm – 5 3/4"	09.08.14	
16,0 cm – 6 1/4"	09.08.16	
20,0 cm – 8"	09.08.20	



1:1

24,0 cm – 9 1/2"	09.08.24	
------------------	-----------------	--

mit Ohr
with eye
con ojete
avec chas
con ansa

mit Ohr
with eye
con ojete
avec chas
con ansa



1:1

13,0 cm – 5 1/8"	09.10.13	
14,5 cm – 5 3/4"	09.10.14	
16,0 cm – 6 1/4"	09.10.16	
20,0 cm – 8"	09.10.20	

mit Ohr
with eye
con ojete
avec chas
con ansa



1:1

Mod.USA

rostfrei
stainless steel
inoxidable
inossidabile

13,0 cm – 5 1/8"	09.11.13	
14,5 cm – 5 3/4"	09.11.14	
15,0 cm – 6"	09.11.15	
18,0 cm – 7 1/8"	09.11.18	
20,0 cm – 8"	09.11.20	



Tränenkanalsonden
Lacrimal probes
Sondas exploradoras para canal lagrimal
Sondes exploratrices pour le canal lacrymal
Sonde esploratrici per canale lacrimale

1:1



13,0 cm – 5 1/8"

Bowman

aus Neusilber Nickel silver de plata alemana en maillechort in argentone	60.34.00	# 0000 / 000	aus Silber Sterling silver de plata pura en argent pur in argento puro	60.34.10	# 0000 / 000
	60.34.01	# 00 / 0		60.34.11	# 00 / 0
	60.34.02	# 1 / 2		60.34.12	# 1 / 2
	60.34.04	# 3 / 4		60.34.14	# 3 / 4
	60.34.06	# 5 / 6		60.34.16	# 5 / 6
	60.34.08	# 7 / 8		60.34.18	# 7 / 8

1:1



13,0 cm – 5 1/8"

Bowman (Williams)

aus Neusilber Nickel silver de plata alemana en maillechort in argentone	60.34.21	# 00 / 0	aus Silber Sterling silver de plata pura en argent pur in argento puro	60.34.31	# 00 / 0
	60.34.22	# 1 / 2		60.34.32	# 1 / 2
	60.34.24	# 3 / 4		60.34.34	# 3 / 4
	60.34.26	# 5 / 6		60.34.36	# 5 / 6
	60.34.28	# 7 / 8		60.34.38	# 7 / 8

Größenskala für Sonden
Size scale for probes
Escala comparativa para sondas
Echelle comparative pour sondes
Scala comparativa per sonde

#	0000	000	00	0	1	2	3	4	5	6	7	8
Ø (mm)	0,6	0,7	0,8	0,9	1,0	1,1	1,2	1,3	1,4	1,5	1,6	1,7



Hohlsonden
Directors
Sondas acanaladas
Sondes cannelées
Specilli scanalati



1:1

11,5 cm - 4½"	09.15.11
14,5 cm - 5¾"	09.15.14
16,0 cm - 6¼"	09.15.16
18,0 cm - 7⅛"	09.15.18
20,0 cm - 8"	09.15.20



1:1

Nelaton

16,0 cm - 6¼"	09.16.66
---------------	-----------------

Watteträger
Cotton carriers
Porta-algodones
Porte-coton
Portacotone

spiralförmig
spiral threads
estrias espirales
striure en spirale
striatura a spirale



1:1

Frohn

12,0 cm - 4¾"	09.20.12		Ø 1,0 mm
14,0 cm - 5½"	09.20.14		Ø 1,0 mm
16,0 cm - 6¼"	09.20.16		Ø 1,0 mm





MEDICON

instruments

OMF SURGERY





OMF INSTRUMENTS



Nervhäkchen
 Nerve hooks
 Ganchitos para nervios
 Crochets à nerfs
 Uncini per nervi



Cushing

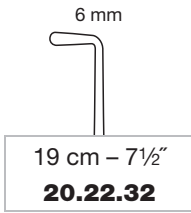
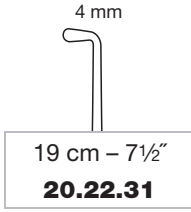

Joseph

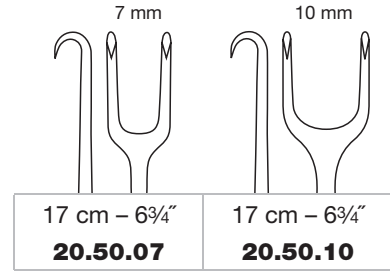
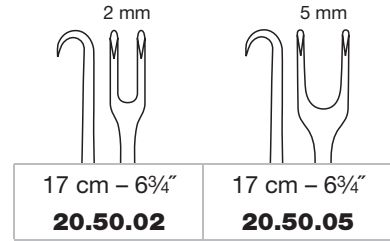

Venenhaken
 Vein retractor
 Gancho para venas
 Ecarteur à veines
 Divaricatore per vene



Cushing

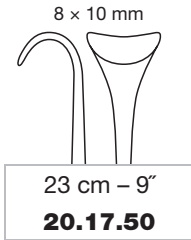

Senn-Miller

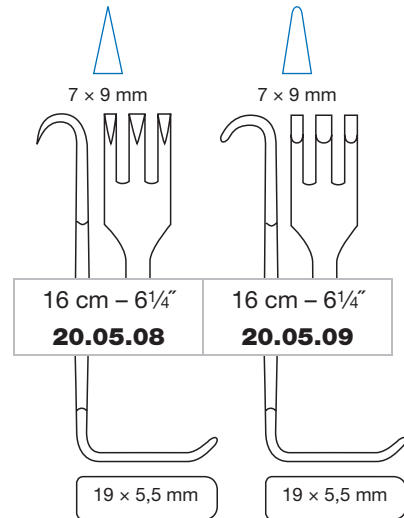

Venenhaken
 Vein retractors
 Ganchos para venas
 Ecarteurs à veines
 Divaricatori per vene



Cushing

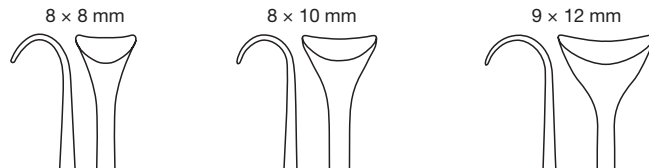

20 cm – 8"	20.17.08	20.17.10	20.17.12
24 cm – 9½"	20.17.28	20.17.30	20.17.32

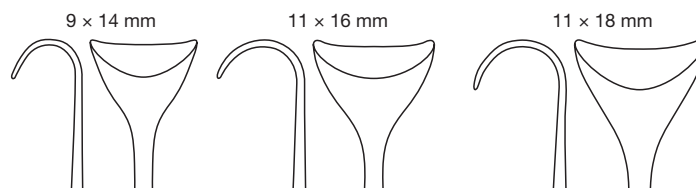

20 cm – 8"	20.17.14	20.17.16	20.17.18
24 cm – 9½"	20.17.34	20.17.36	20.17.38

Das zweifach gebogene Arbeitsende ("S"-Form) ermöglicht eine freie Sicht auf das OP-Feld und erleichtert das Assistieren.

The double curved ("S"-form) working end enables a good sight on the operating field and facilitates the assistance.

El extremo de trabajo doble curvado (en forma "S") posibilita una buena visión sobre el campo operatorio y facilita la asistencia.

L'extrémité deux fois coudée (en forme de "S") permet une bonne vue sur le champs opératoire et simplifie aussi l'assistance.

L'estremità doppia curvata (forma di "S") rende possibile una migliore vista sul campo operatorio e facilita anche l'assistenza.



Benicke

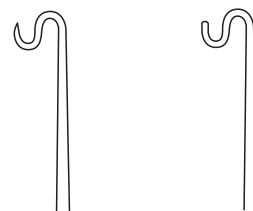

19 cm – 7½"	19 cm – 7½"
20.48.10	20.48.11

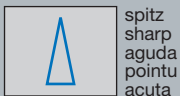

spitz
 sharp
 aguda
 pointu
 acuta



stumpf
 blunt
 roma
 mousse
 smussa



Hauthäkchen
 Skin hook
 Ganchito para piel
 Crochet à peau
 Uncino per pelle

2 mm
 14 cm – 5½"
20.22.01

3 mm
 14 cm – 5½"
20.22.02

4 mm
 14 cm – 5½"
20.22.03

Lucae

3 mm
 12,5 cm – 5"
20.30.12

Frazier

1,5 x 2 mm
 13 cm – 5⅛"
20.52.10

2 x 3 mm
 13 cm – 5⅛"
20.52.11

Guthrie

3 mm
 19 cm – 7½"
20.30.19

5 mm
 19 cm – 7½"
20.30.20

Gillies

3 mm
 15 cm – 6"
20.35.01

3 mm
 15 cm – 6"
20.35.02

Barsky

Hauthäkchen
 Skin hooks
 Ganchitos para piel
 Crochets à peau
 Uncini per pelle



9 × 2 mm	9 × 8 mm	9 × 10 mm	9 × 14 mm	
16 cm – 6¼"	16 cm – 6¼"	16 cm – 6¼"	16 cm – 6¼"	△
20.64.01	20.64.02	20.64.03	20.64.04	

9 × 2 mm	9 × 8 mm	9 × 10 mm	9 × 14 mm	
16 cm – 6¼"	16 cm – 6¼"	16 cm – 6¼"	16 cm – 6¼"	△
20.65.01	20.65.02	20.65.03	20.65.04	



7 × 1 mm	7 × 5 mm	7 × 8 mm	7 × 11 mm	
16 cm – 6¼"	16 cm – 6¼"	16 cm – 6¼"	16 cm – 6¼"	△
20.66.01	20.66.02	20.66.03	20.66.04	

7 × 1 mm	7 × 5 mm	7 × 8 mm	7 × 11 mm	
16 cm – 6¼"	16 cm – 6¼"	16 cm – 6¼"	16 cm – 6¼"	△
20.67.01	20.67.02	20.67.03	20.67.04	



spitz
 sharp
 aguda
 pointu
 acuta



stumpf
 blunt
 roma
 mousse
 smussa



Feine Wundhaken
Delicate Retractors
Separadores finos
Ecarteurs fins
Divaricatori delicati

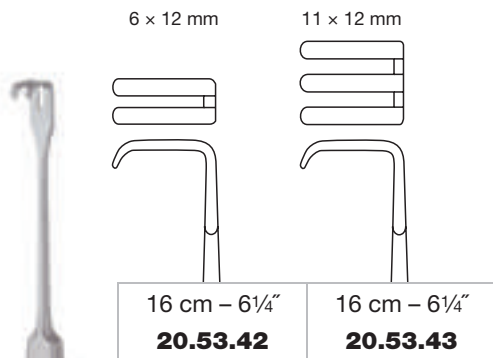

Wundhaken
 Retractors
 Separadores
 Ecarteurs
 Divaricatori

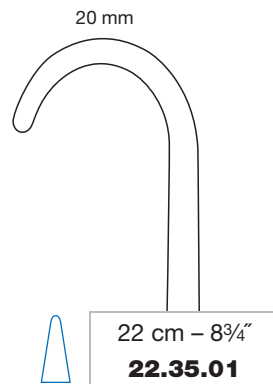
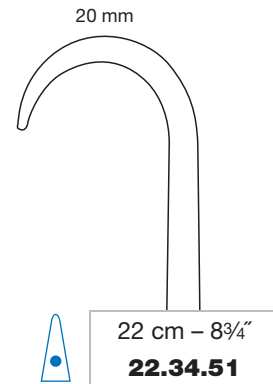
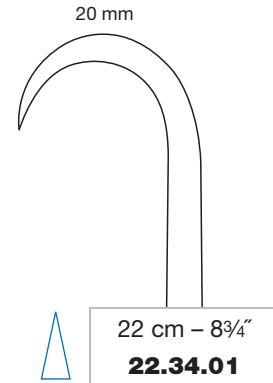

Volkmann



spitz
 sharp
 aguda
 pointu
 acuta



halbscharf
 semi sharp
 semi aguda
 semi pointu
 semi acuta



stumpf
 blunt
 roma
 mousse
 smussa

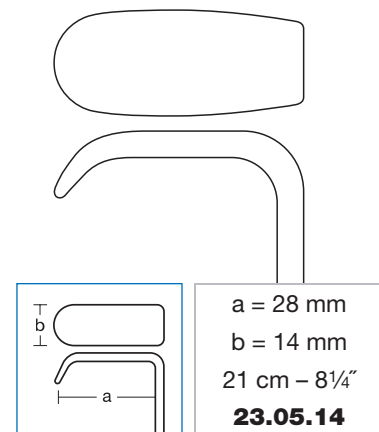
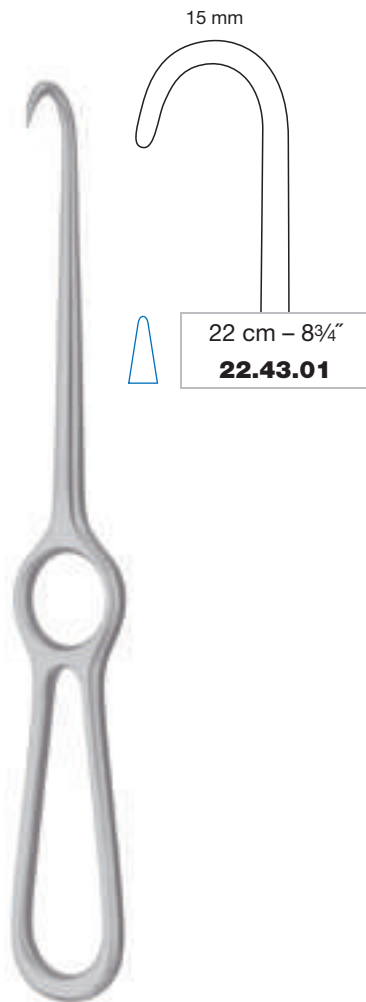
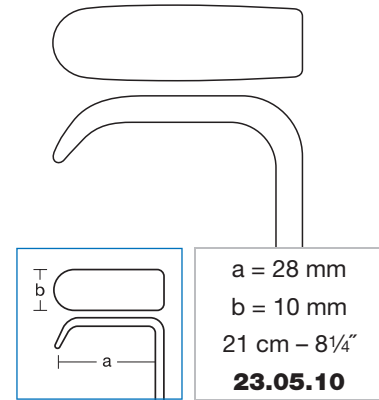
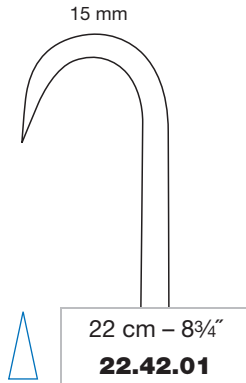

Kocher



Langenbeck

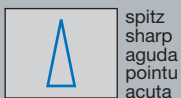
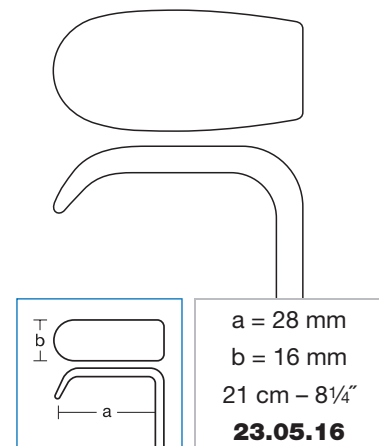



Volkmann

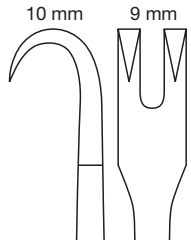

10 mm 9 mm
 21 cm - 8 1/4"
22.30.02

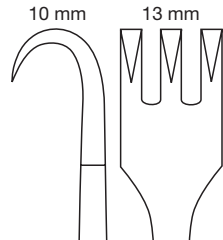

10 mm 13 mm
 21 cm - 8 1/4"
22.30.03

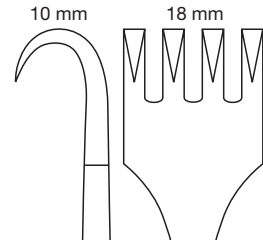

10 mm 18 mm
 21 cm - 8 1/4"
22.30.04

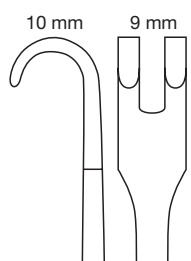

10 mm 9 mm
 21 cm - 8 1/4"
22.31.02

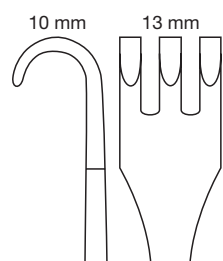

10 mm 13 mm
 21 cm - 8 1/4"
22.31.03

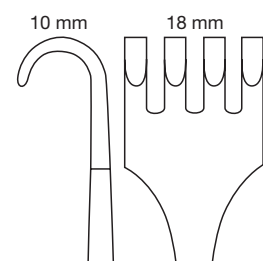

10 mm 18 mm
 21 cm - 8 1/4"
22.31.04



Kocher

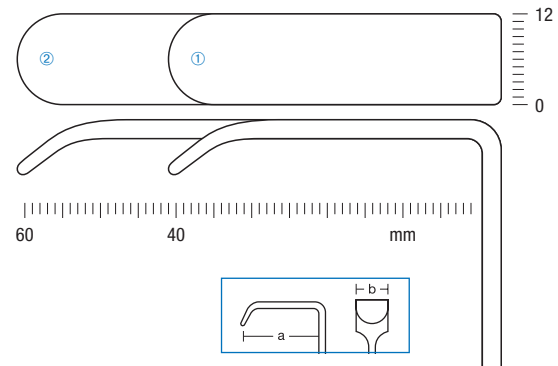

①	23.21.01	22 cm - 8 3/4"	a = 40 mm	b = 12 mm
②	23.21.02	22 cm - 8 3/4"	a = 60 mm	b = 12 mm



spitz
 sharp
 aguda
 pointu
 acuta



stumpf
 blunt
 roma
 mousse
 smussa

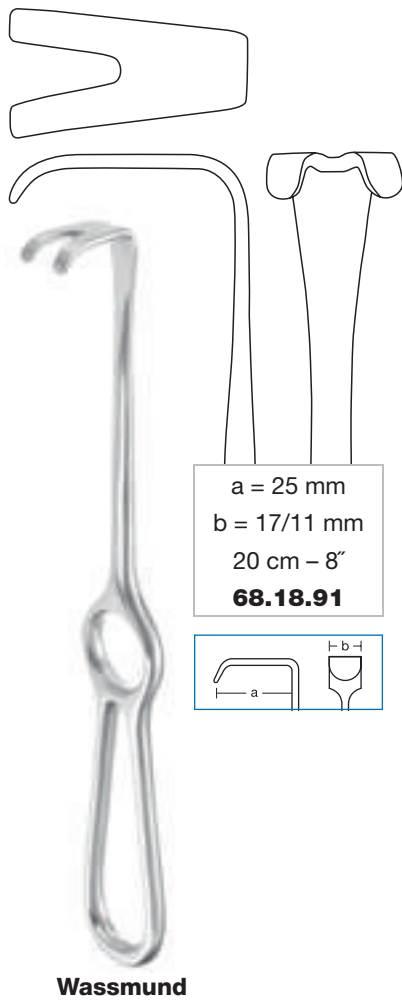

a = 25 mm
 b = 17/11 mm
 20 cm - 8"
68.18.91



Wassmund



Middeldorpf

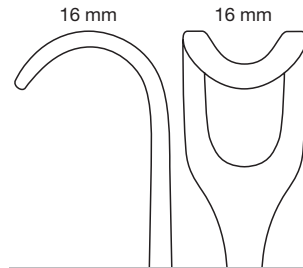

①	23.33.01	19,5 cm - 7 ³ / ₄ "
②	23.33.11	20,5 cm - 8"

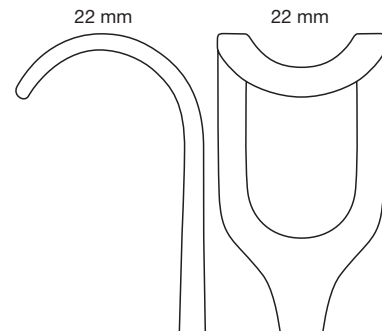

①	23.33.02	20,5 cm - 8"
②	23.33.12	22,5 cm - 9"



Middeldorpf

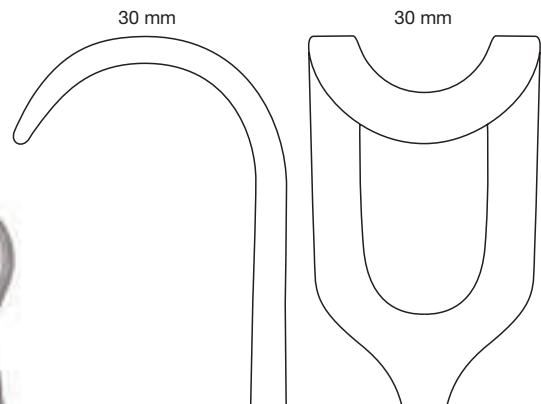

①	23.33.03	23,0 cm - 9"
②	23.33.13	23,5 cm - 9 ¹ / ₄ "



Langenbeck-Kocher

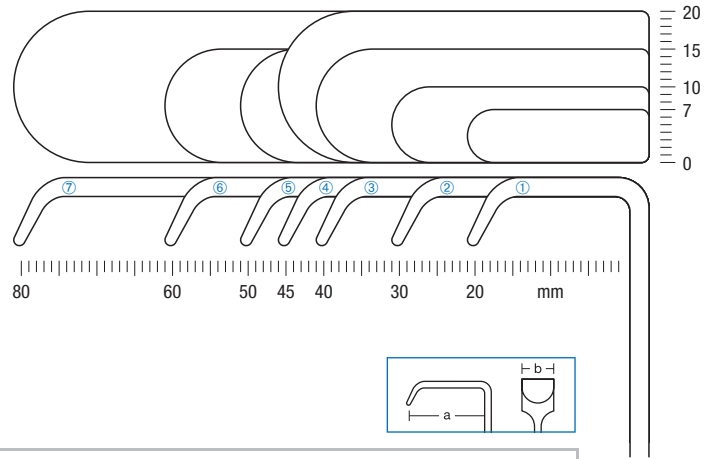

①	23.25.01	21 cm – 8¼"	a = 20 mm	b = 7 mm
	23.25.02	21 cm – 8¼"	a = 30 mm	b = 7 mm
	23.25.03	21 cm – 8¼"	a = 30 mm	b = 10 mm
②	23.25.04	21 cm – 8¼"	a = 30 mm	b = 15 mm
	23.25.05	21 cm – 8¼"	a = 30 mm	b = 20 mm
	23.25.06	21 cm – 8¼"	a = 40 mm	b = 10 mm
③	23.25.07	21 cm – 8¼"	a = 40 mm	b = 15 mm
	23.25.08	21 cm – 8¼"	a = 40 mm	b = 20 mm
	23.25.09	21 cm – 8¼"	a = 45 mm	b = 20 mm
	23.25.10	21 cm – 8¼"	a = 50 mm	b = 10 mm
⑤	23.25.11	21 cm – 8¼"	a = 50 mm	b = 15 mm
	23.25.12	21 cm – 8¼"	a = 60 mm	b = 20 mm
	23.25.13	21 cm – 8¼"	a = 80 mm	b = 15 mm
⑦	23.25.14	21 cm – 8¼"	a = 80 mm	b = 20 mm



Die Rinne dient zur stabilen Führung von Bohrer und Schraubendreher und unterstützt die Verschraubung besonders in schwer zugänglichen Bereichen.

The channel enables a secure guidance of drill and screwdriver and supports screwing in areas with difficult access.

La ranura sirve como guía estable para el perforador y atornillador y apoya el atornillamiento sobre todo en regiones menos accesibles.

Le conduit sert au guidage stable de forets et de tournevis et supporte le vissage dans des régions dont l'accès est difficile.

La scanalatura serve per una guida stabile del perforatore e cacciavite e sostiene l'avvitamento in parti difficilmente accessibili.

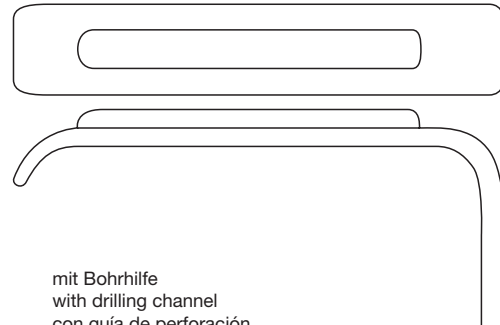
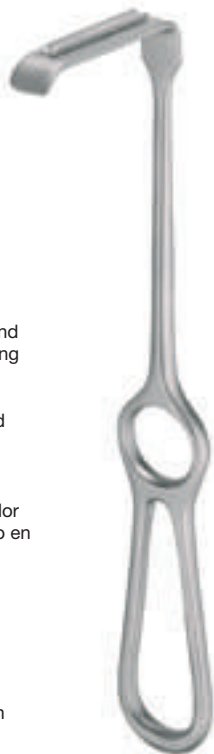

mit Bohrhilfe
 with drilling channel
 con guía de perforación
 avec guide pour perçage
 con guida per la perforazione

a = 60 mm
 b = 12 mm
 21 cm – 8 1/4"
68.05.30



Kretschmer

Progenie-Rinnen
 Channel retractors
 Separadores mandibulares
 Ecarteurs mandibulaires
 Divaricatori mandibolari



Obwegeser

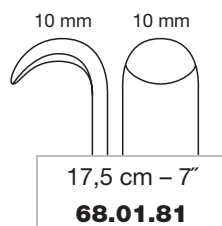
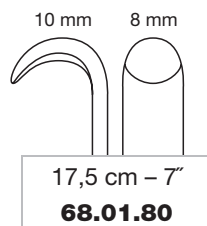

Kinnhalter
 Chin retractor
 Gancho de mentón
 Fixe-menton
 Gancio per mento

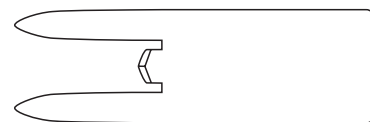

Obwegeser

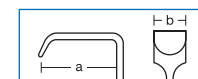
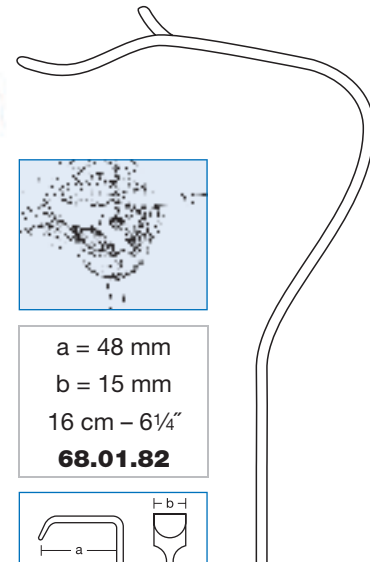



Unterkieferrand-Retraktor
Mandibular rim retractor
Separador para el borde del maxilar inferior
Ecarteur pour le bord du maxillaire inférieur
Divaricatore per il bordo della mascella inferiore



Alveolar-Haken
Alveolar retractor
Separador alveolar
Ecarteur alveolaire
Uncino alveolare



a = 45 mm
b = 9/12 mm
17 cm - 6³/₄"
68.01.53

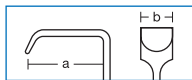

Obwegeser

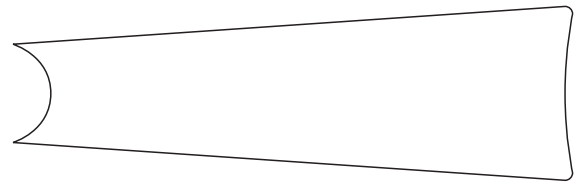

a = 70 mm
b = 13/23 mm
22 cm - 8³/₄"
68.01.63

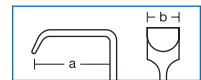

Obwegeser



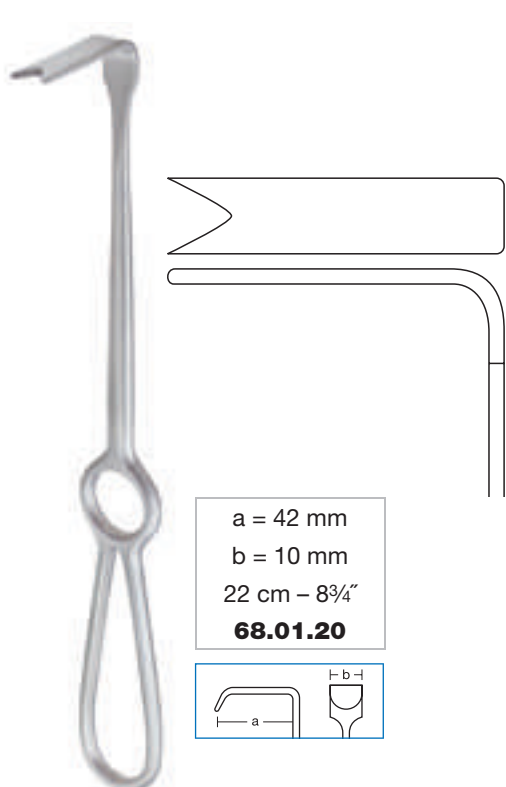

a = 42 mm
 b = 10 mm
 22 cm – 8¾"
68.01.20



Obwegeser

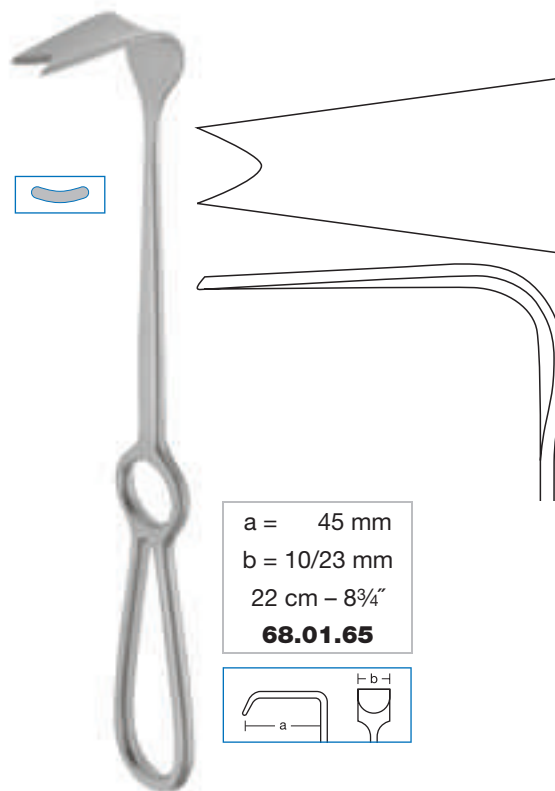

a = 45 mm
 b = 10/23 mm
 22 cm – 8¾"
68.01.65



Obwegeser



Ramus-Klemmen, breit
 Ramus clamps, wide
 Clamps para el ramo, ancho
 Clamps à rameau, large
 Pinze per ramo, largo



a = 75 mm	
b = 20/34 mm	
19 cm – 7½"	19 cm – 7½"
68.01.72	68.01.73

Blatt rechts
 Blade right
 Hoja derecha
 Lame droite
 Valva destra

Blatt links
 Blade left
 Hoja izquierda
 Lame gauche
 Valva sinistra

Obwegeser

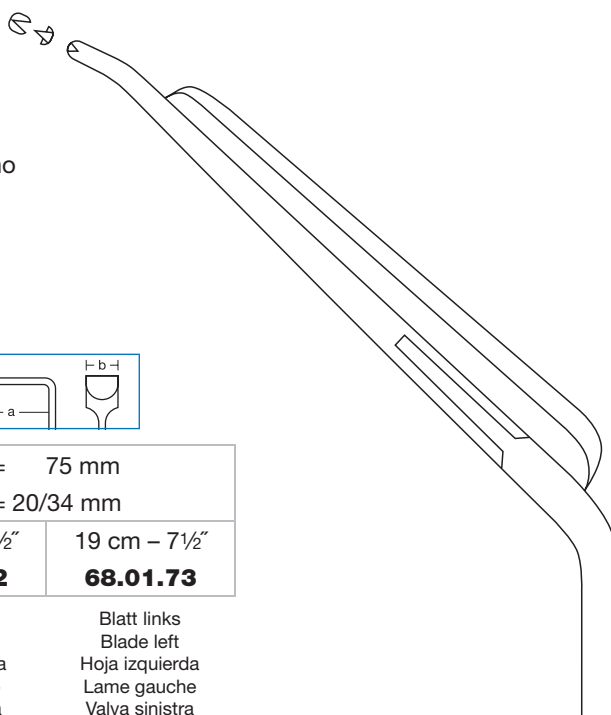

Wundhakenblatt, gewölbt
 Retractor blade, curved
 Hoja de separador, abovedada
 Lame d'ecarteur, courbée
 Valva di divaricatore, convessa



Ramus-Haken
Ramus Retractors
Separadores para el ramo
Ecarteurs à rameau
Divaricatori per ramo

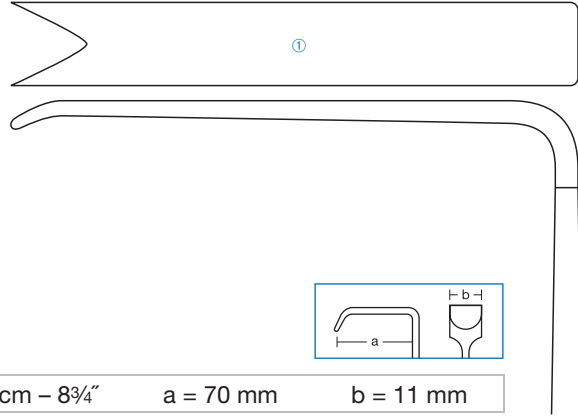
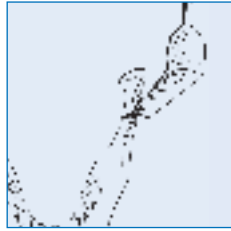

① **68.01.25** 22 cm – 8¾" a = 70 mm b = 11 mm

Obwegeser

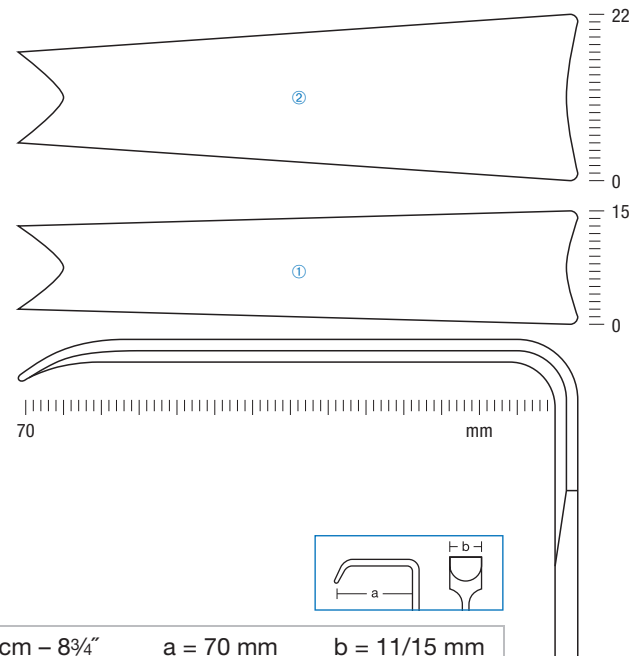
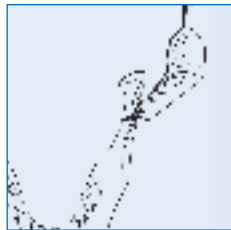

① **68.01.56** 22 cm – 8¾" a = 70 mm b = 11/15 mm
 ② **68.01.57** 22 cm – 8¾" a = 70 mm b = 12/22 mm

Obwegeser

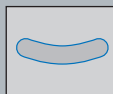



Obwegeser

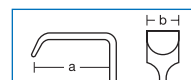
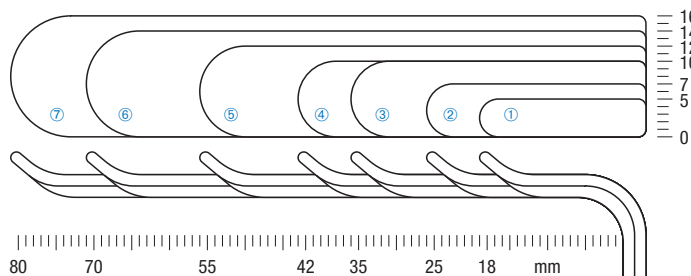

①	68.01.31	23 cm - 9"	a = 18 mm	b = 5 mm
②	68.01.32	23 cm - 9"	a = 25 mm	b = 7 mm
③	68.01.33	23 cm - 9"	a = 35 mm	b = 10 mm
④	68.01.34	23 cm - 9"	a = 42 mm	b = 10 mm
⑤	68.01.35	23 cm - 9"	a = 55 mm	b = 12 mm
⑥	68.01.36	23 cm - 9"	a = 70 mm	b = 14 mm
⑦	68.01.37	23 cm - 9"	a = 80 mm	b = 16 mm



Obwegeser

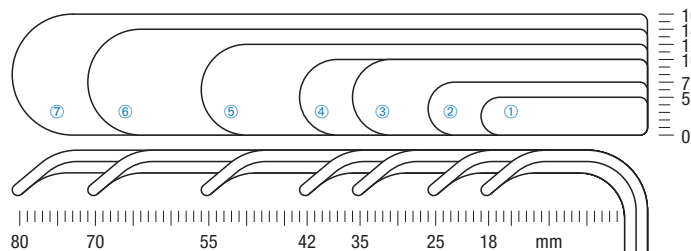
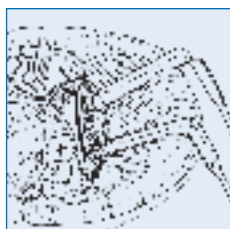

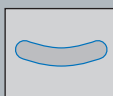

①	68.01.41	22,5 cm - 9"	a = 18 mm	b = 5 mm
②	68.01.42	22,5 cm - 9"	a = 25 mm	b = 7 mm
③	68.01.43	22,5 cm - 9"	a = 35 mm	b = 10 mm
④	68.01.44	22,5 cm - 9"	a = 42 mm	b = 10 mm
⑤	68.01.45	22,5 cm - 9"	a = 55 mm	b = 12 mm
⑥	68.01.46	22,5 cm - 9"	a = 70 mm	b = 14 mm
⑦	68.01.47	22,5 cm - 9"	a = 80 mm	b = 16 mm





Wundhakenblatt, gewölbt
 Retractor blade, curved
 Hoja de separador, abovedada
 Lame d'ecarteur, courbée
 Valva di divaricatore, convessa

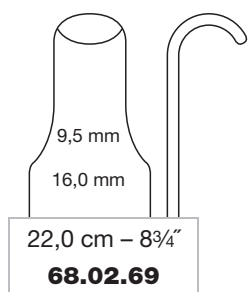

Extraorale und intraorale Retraktoren
Extra and Intra Oral Retractors
Separadores extra orales y intra orales
Ecarteurs extra-oraux et intra-oraux
Divaricatori extraorali e intraorali



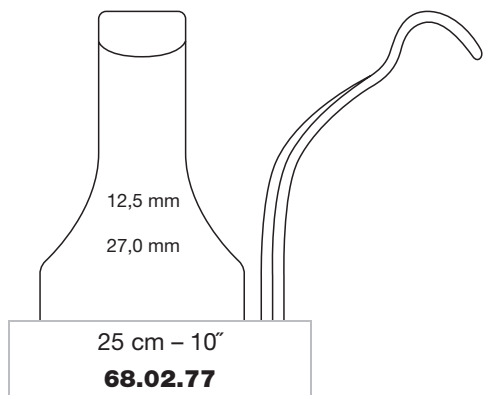

25,5 cm – 10"
68.02.70



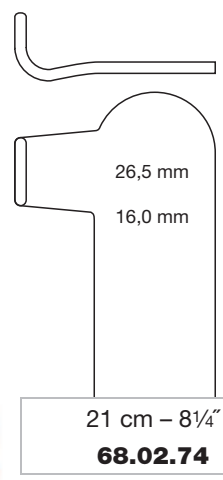

28 cm – 11"
68.02.78

Intraorale Retraktoren
 Intra oral retractors
 Separadores intra orales
 Ecarteurs intra-oraux
 Divaricatori intraorali



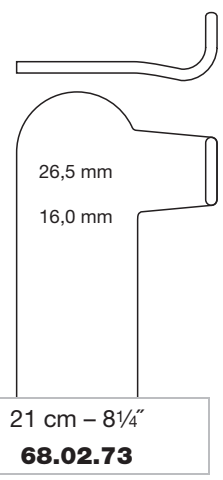

24,5 cm – 9¾"
68.02.76

24,5 cm – 9¾"
68.02.75



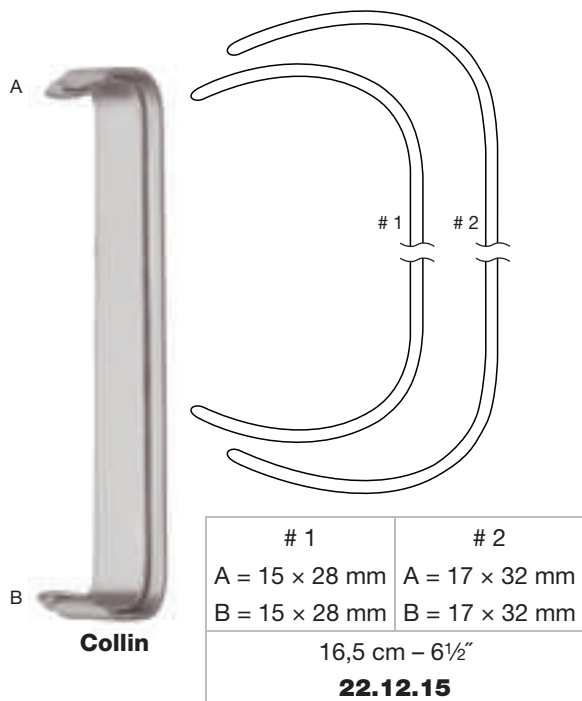

A

B

Collin

# 1	# 2
A = 15 × 28 mm	A = 17 × 32 mm
B = 15 × 28 mm	B = 17 × 32 mm
16,5 cm – 6½"	
22.12.15	

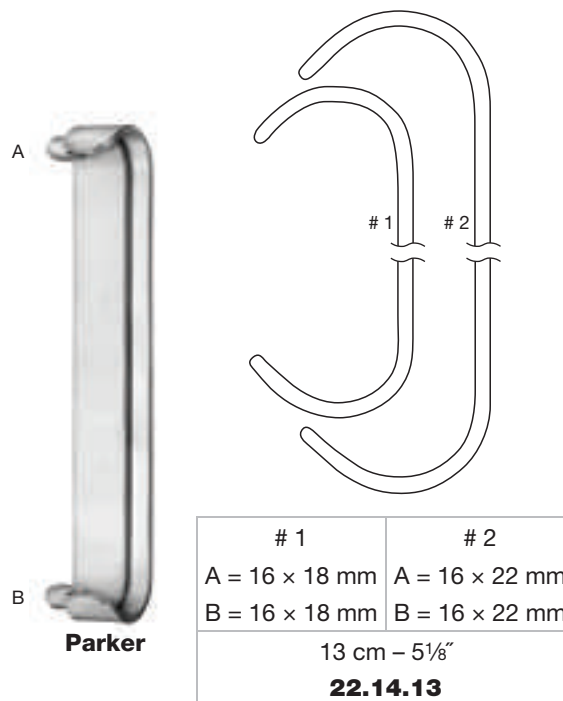

A

B

Parker

# 1	# 2
A = 16 × 18 mm	A = 16 × 22 mm
B = 16 × 18 mm	B = 16 × 22 mm
13 cm – 5⅛"	
22.14.13	

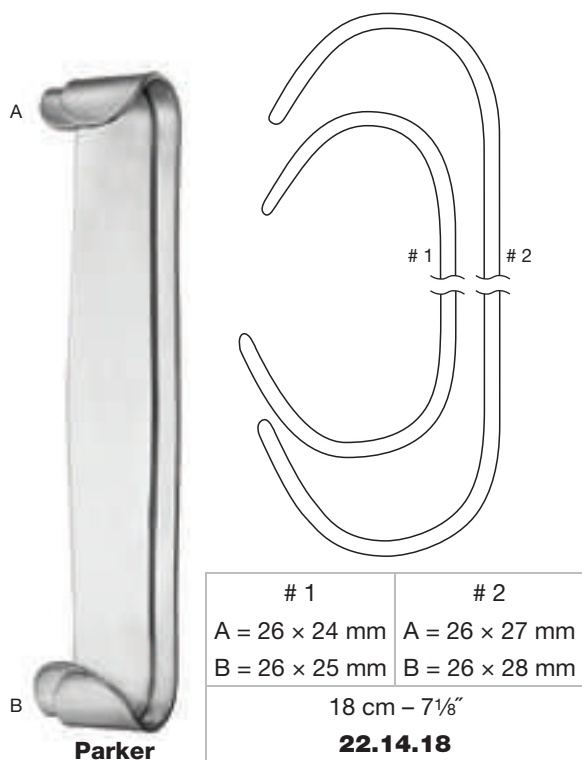

A

B

Parker

# 1	# 2
A = 26 × 24 mm	A = 26 × 27 mm
B = 26 × 25 mm	B = 26 × 28 mm
18 cm – 7⅛"	
22.14.18	

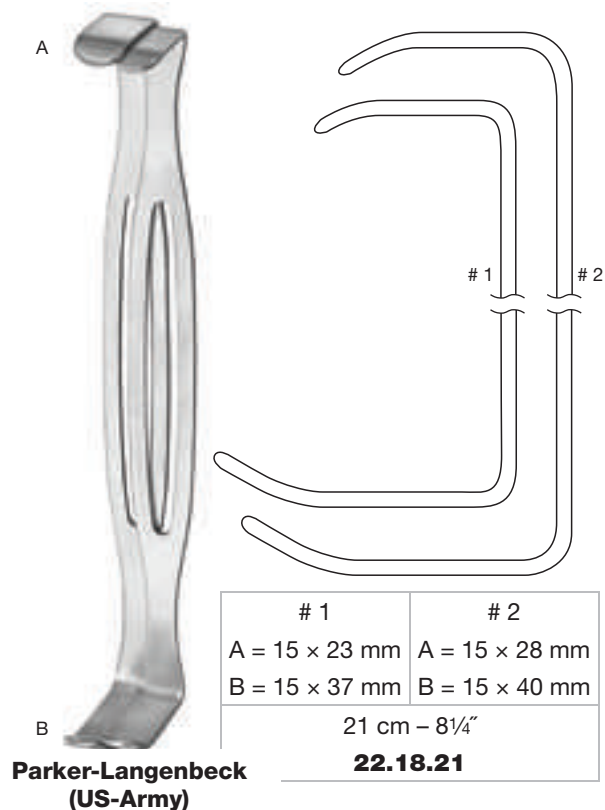

A

B

**Parker-Langenbeck
 (US-Army)**

# 1	# 2
A = 15 × 23 mm	A = 15 × 28 mm
B = 15 × 37 mm	B = 15 × 40 mm
21 cm – 8¼"	
22.18.21	



Roux

Satz komplett
 Set complete
 Juego completo
 Jeu complet
 Set completa
22.16.00

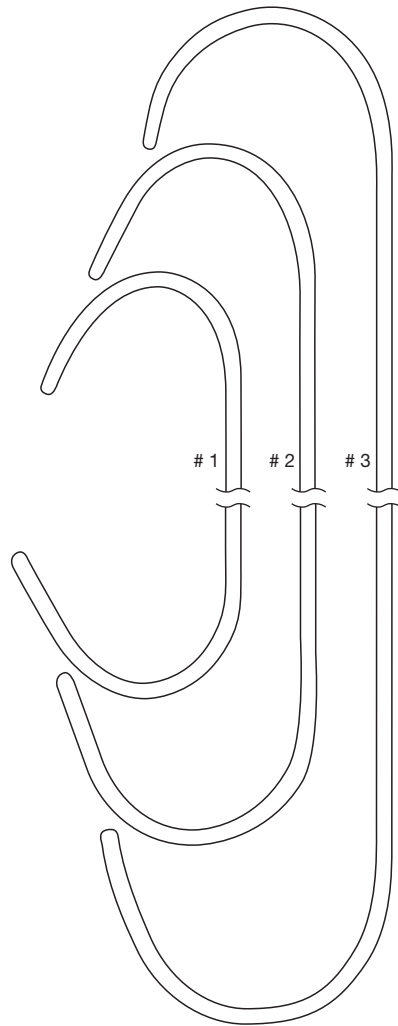

1
 A = 22 × 28 mm
 B = 28 × 25 mm
 14 cm – 5½″
22.16.14

2
 A = 26 × 23 mm
 B = 38 × 29 mm
 15 cm – 6″
22.16.15

3
 A = 29 × 29 mm
 B = 44 × 34 mm
 16,5 cm – 6½″
22.16.16



21 cm – 8¼"
68.01.97

für Oberkiefer
 for upper jaw
 para mandíbula superior
 pour mâchoire supérieure
 per mascella superiore



26 cm – 10¼"
68.01.98

für Unterkiefer
 for lower jaw
 para mandíbula inferior
 pour mâchoire inférieure
 per mascella inferiore



15 cm – 6"
68.01.99

universal
 universal
 universal
 universel
 universale

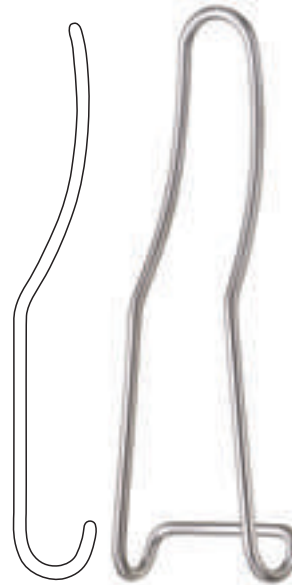

14,5 cm – 5¾"
72.02.15

mit Zungendrucker
 with tongue depressor
 con bajalengua
 avec abaisse-langue
 con abbassalingua

Sternberg

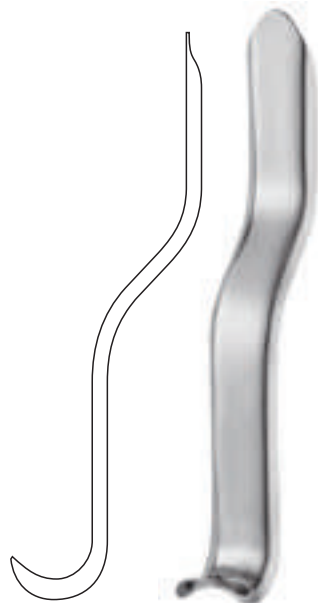

15,5 cm – 6 1/8"
72.02.10

mit Zungendrucker
 with tongue depressor
 con bajalengua
 avec abaisse-langue
 con abbassalingua

Univ. Minnesota Cawood

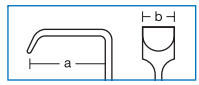
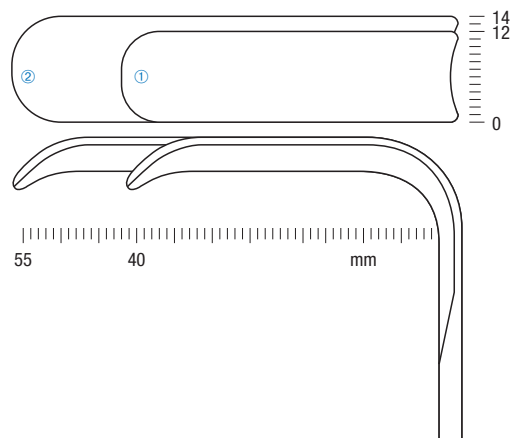

①	68.18.92	21 cm – 8 1/4"	a = 40 mm	b = 12 mm
②	68.18.93	21 cm – 8 1/4"	a = 55 mm	b = 14 mm

Dockhorn



Lidhalter
 Lid retractors
 Separadores para párpados
 Releveurs à paupières
 Elevatori per palpebre

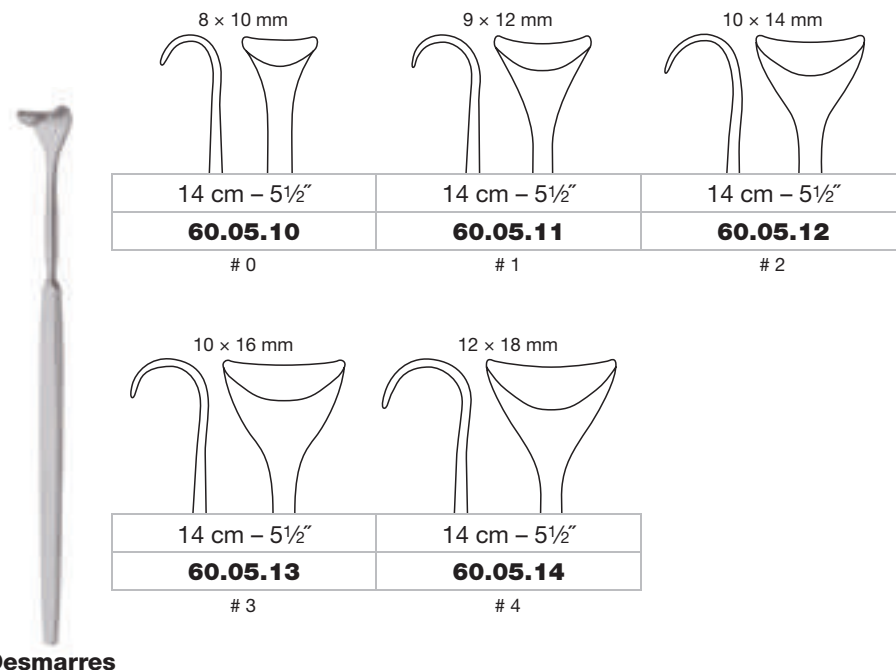

Desmarres

8 × 10 mm	9 × 12 mm	10 × 14 mm
14 cm – 5½"	14 cm – 5½"	14 cm – 5½"
60.05.10	60.05.11	60.05.12
# 0	# 1	# 2
10 × 16 mm	12 × 18 mm	
14 cm – 5½"	14 cm – 5½"	
60.05.13	60.05.14	
# 3	# 4	

Orbitahaken
 Orbital hooks
 Separadores orbitales
 Crochets orbitaux
 Retrattore orbitale

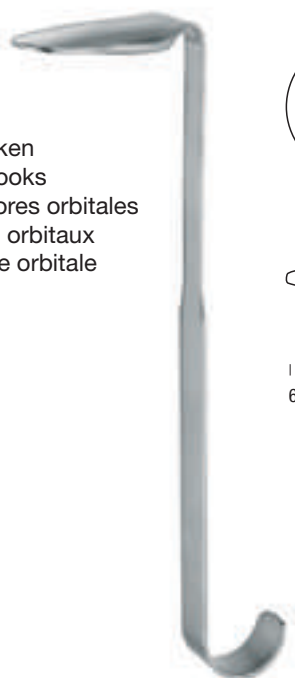

Kluba

①	68.82.31	19 cm – 7½"	a = 45 mm	b = 24 mm
②	68.82.32	19 cm – 7½"	a = 55 mm	b = 28 mm
③	68.82.33	19 cm – 7½"	a = 65 mm	b = 32 mm



Wundspreizer, Nasenhaken und Lidplatte
Self-retaining Retractors, Nasal Retractors and Lid Plate
Separadores autoestáticos, separadores nasales y placa para párpados
Ecarteurs autostatiques, ecarteurs nasaux et plaque à paupières
Divaricatori autostatici, divaricatori nasali e piastra per palpebre

Wundspreizer
 Self-retaining retractors
 Separadores autoestáticos
 Ecarteurs autostatiques
 Divaricatori autostatici

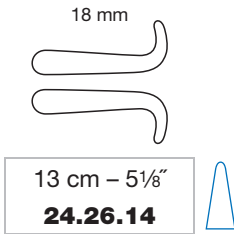
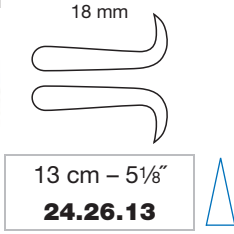

Weitlaner-Wullstein

Lidplatte
 Lid plate
 Placa para párpados
 Plaque à paupières
 Piastra per palpebre



Jaeger
 11 cm - 4 3/8"
60.05.95



Gubisch-Aufricht

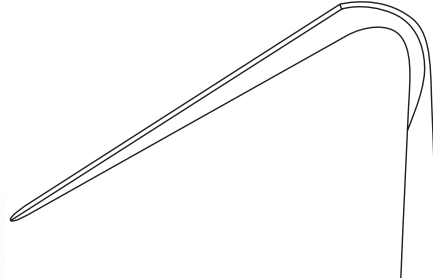
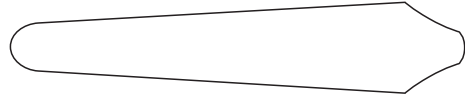

Nasenhaken
 Nasal retractor
 Separador nasal
 Ecarteur nasaux
 Divaricatore nasale

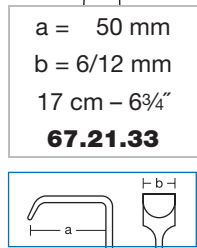

a = 50 mm
 b = 6/12 mm
 17 cm - 6 3/4"
67.21.33

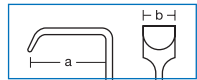

Aufricht

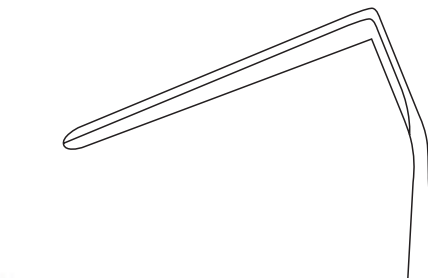

Nasenhaken
 Nasal retractor
 Separador nasal
 Ecarteurs nasaux
 Divaricatore nasale

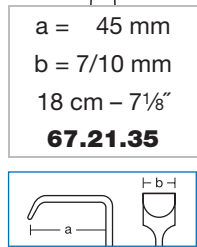

a = 45 mm
 b = 7/10 mm
 18 cm - 7 1/8"
67.21.35

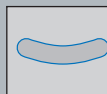

Wundhakenblatt, gewölbt
 Retractor blade, curved
 Hoja de separador, abovedada
 Lame d'ecarteur, courbée
 Valva di divaricatore, convessa



scharf
 sharp
 agudo
 pointu
 acuto



stumpf
 blunt
 romo
 moussu
 smusso

1:1.5

Holz
 Wood
 Madera
 Bois
 Legno



16 cm – 6¼" **72.00.01** P₁₀₀



14,5 cm – 5¾" **72.00.10**



14,0 cm – 5½" **72.00.15**



18,0 cm – 7⅛" **72.00.18** Buchwald



19,0 cm – 7½" **72.00.50** Brünings



a = 29 mm	12,0 cm – 4¾"	72.00.27	Doyen	b = 22 mm
a = 33 mm	16,0 cm – 6¼"	72.00.28	Doyen	b = 30 mm



Verpackungseinheit "X" Stück
 Packing unit "X" pieces
 Paquete de "X" unidades
 Emballage de "X" pièces
 Confezione da "X" pezzi



Zungendrucker
Tongue Depressors
Bajalenguas
Abaisse-langues
Abbassalingua

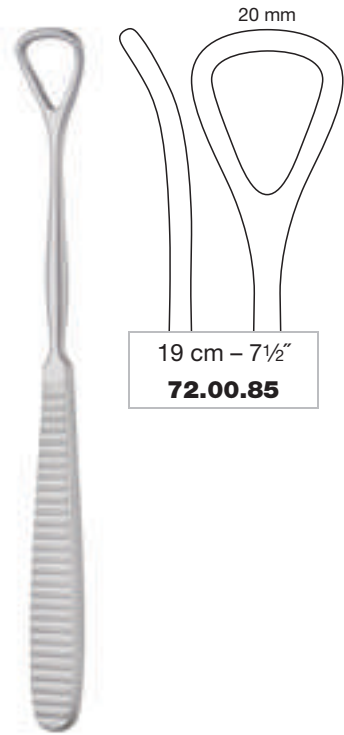

20 mm
 19 cm - 7½"
72.00.85

Moritz-Schmidt

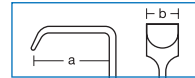
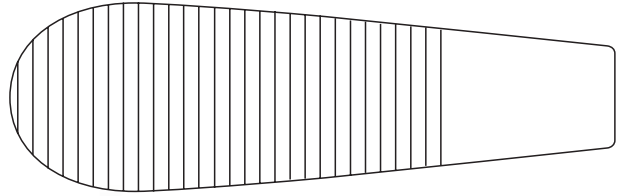

a = 80 mm
 b = 25 mm
72.01.15

Tobold

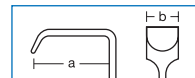
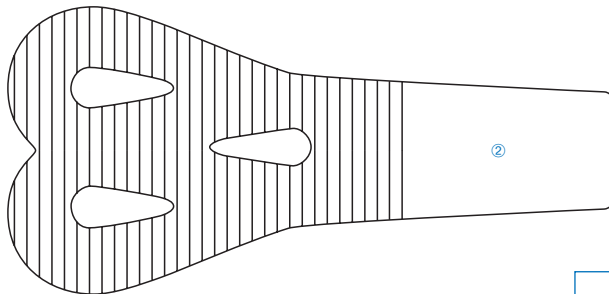
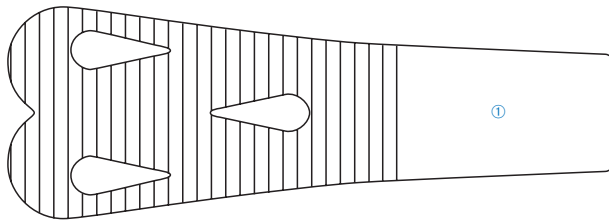

①	72.01.40	a = 80 mm	b = 28 mm
②	72.01.41	a = 80 mm	b = 38 mm



Wieder

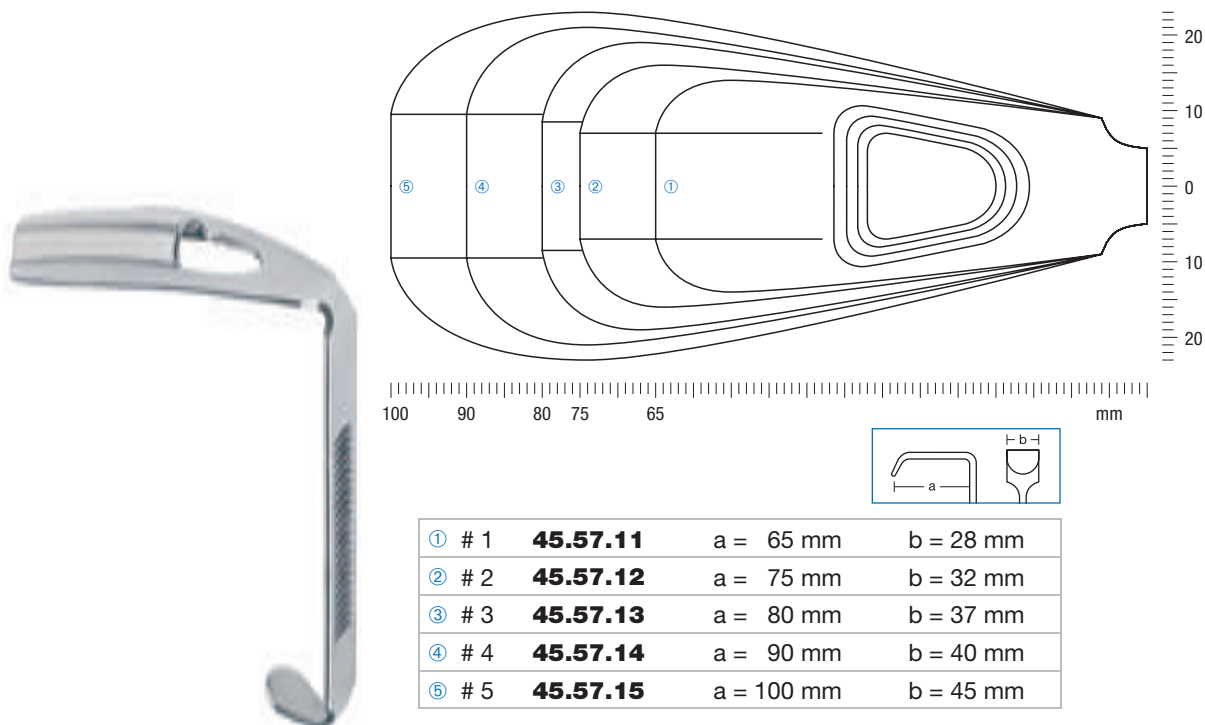

① # 1	45.57.11	a = 65 mm	b = 28 mm
② # 2	45.57.12	a = 75 mm	b = 32 mm
③ # 3	45.57.13	a = 80 mm	b = 37 mm
④ # 4	45.57.14	a = 90 mm	b = 40 mm
⑤ # 5	45.57.15	a = 100 mm	b = 45 mm

Kilner-Doughty

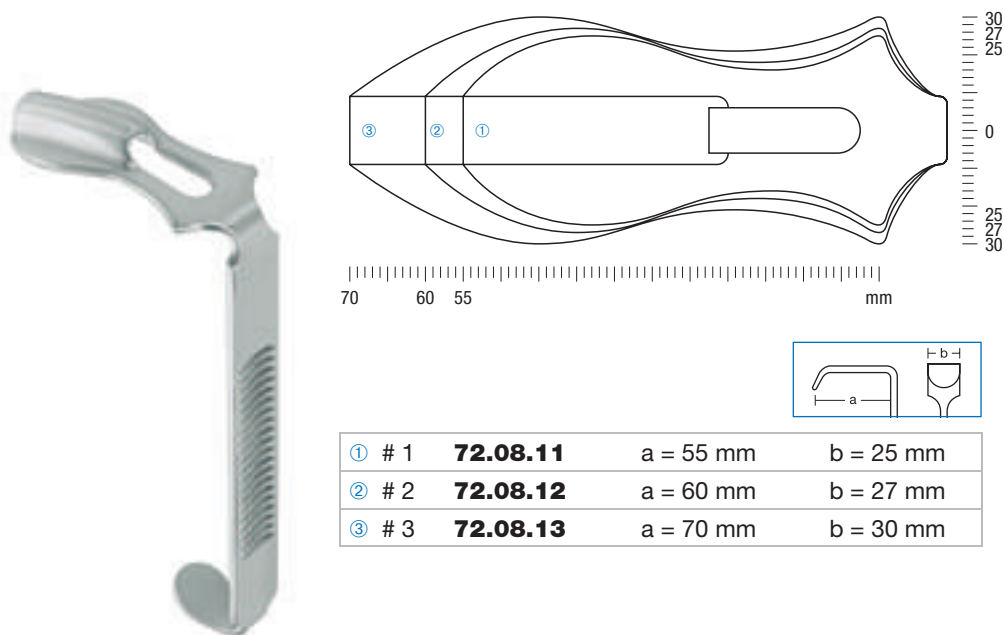

① # 1	72.08.11	a = 55 mm	b = 25 mm
② # 2	72.08.12	a = 60 mm	b = 27 mm
③ # 3	72.08.13	a = 70 mm	b = 30 mm

Dingman



Zungendrucker und Zungenzangen
Tongue Depressor and Tongue Seizing Forceps
Bajalengua y pinzas tiralengua
Abaisse-langue et pinces tire-langue
Abbassalingua e pinze tiralingua

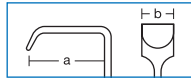
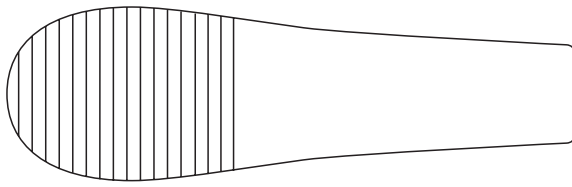

a = 75 mm
 b = 23 mm
72.01.25



45.82.17

Ersatz-Gummieinlagen (Paar)
 Spare rubber inserts (pair)
 Gomas de repuesto (par)
 Mors en caouchouc de rechange (paires)
 Gommini di ricambio (paio)

Hartmann



Collin

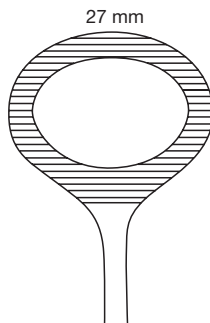

27 mm
 17 cm - 6³/₄"
45.81.17



Young



14 mm
 16 cm - 6¹/₄"
45.82.16



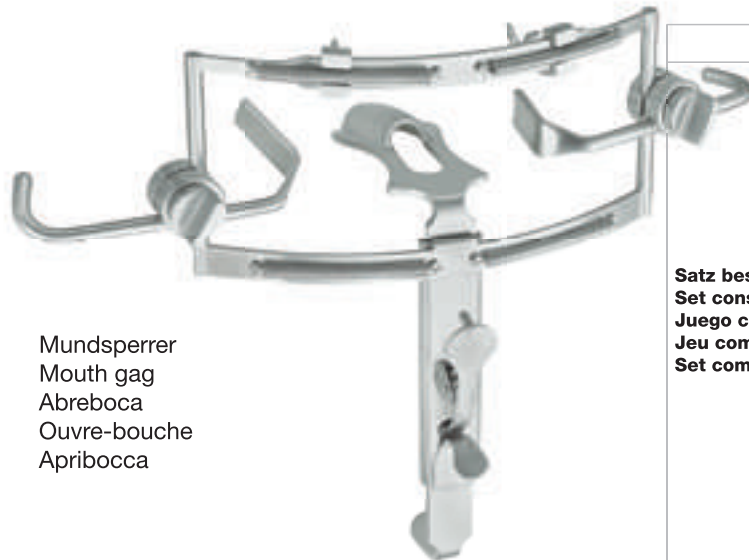

Mundsperrer
Mouth gag
Abreboca
Ouvre-bouche
Apribocca

Dingman

72.08.00	
Rahmen Frame Bastidor Cadre Telaio	1 x
Zahnhaken Tooth hooks Ganchos dentales Crochets dentaires Ganci dentali	2 x
Wangenhaken Cheek retractors Separadores de mejillas Ecarteurs pour joues Divaricatori per guancia	2 x
Zungendrucker Tongue depressors	1 x 72.08.11
Bajalenguas	1 x 72.08.12
Abaisse-langues	1 x 72.08.13
Abbassalingua	

Satz bestehend aus:
Set consisting of:
Juego compuesto por:
Jeu composé de:
Set composto da:

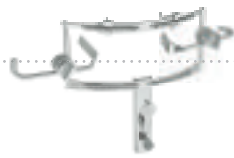

72.08.20

Rahmen, allein (ohne Zungendrucker)
Frame, only (without tongue depressors)
Bastidor, solo (sin bajalenguas)
Cadre, seul (sans abaisse-langues)
Telaio, solo (senza abbassalingua)

Zungendrucker (siehe Seite 77)
Tongue depressors (see page 77)
Bajalenguas (véase página 77)
Abaisse-langues (voir page 77)
Abbassalingua (vedi pagina 77)

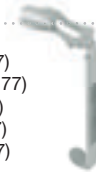

72.08.11 # 1

72.08.12 # 2

72.08.13 # 3

Mundkeile
Mouth gags
Abre bocas
Baïllons
Apribocca



McKesson

für Kleinkinder
for infants
para niños pequeños
pour petits enfants
per infanti

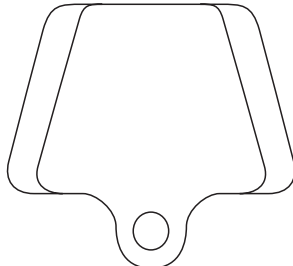

72.10.01



für Kinder
for children
para niños
pour enfants
per bambini

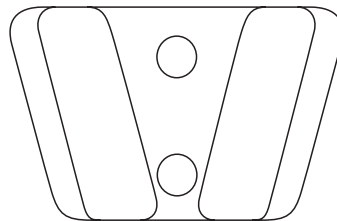

72.10.02



für Erwachsene
for adults
para adultos
pour adultes
per adulti

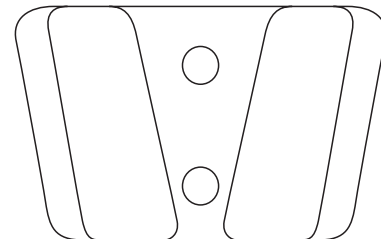

72.10.03



Verpackungseinheit "X" Stück
Packing unit "X" pieces
Paquete de "X" unidades
Emballage de "X" pièces
Confezione da "X" pezzi



Mundsperrer und Zungenspatel
Mouth Gags and Tongue Spatulas
Abrebocas y espátulas bucales
Ouvre-bouches et spatules à langue
Apribocca e spatole per lingua

Mundsperrer
Mouth gags
Abrebocas
Ouvre-bouches
Apribocca

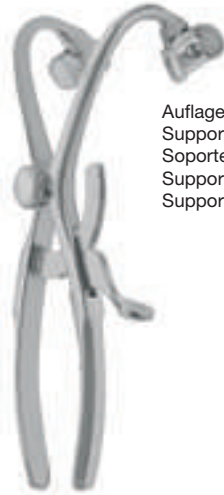

Auflagen, beweglich
Supports, movable
Soportes, móviles
Support, mobiles
Supporti, mobili

Denhart-Hoefert
12,5 cm – 5"
72.05.63



Denhart
13 cm – 5 1/8"
72.05.60

Zungenspatel
Tongue spatulas
Espátulas bucales
Spatules à langue
Spatole per lingua



Hanna
20 cm – 8"
72.00.52



Claudinha
21 cm – 8 1/4"
72.00.56

Zungenspatel verwendbar nur mit Mundsperrer:
Tongue spatulas only for use with mouth gag:
Espátulas bucales sólo aplicable con el abrebooca:
Spatules à langue seulement à utiliser avec l'ouvre-bouche:
Spatole per lingua utilizzabile solo con l'apribocca:

72.05.63 Denhart-Hoefert

medicon-cat OMF



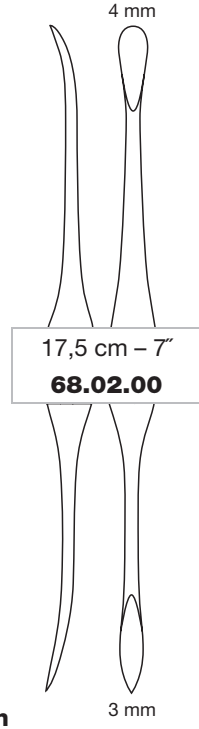
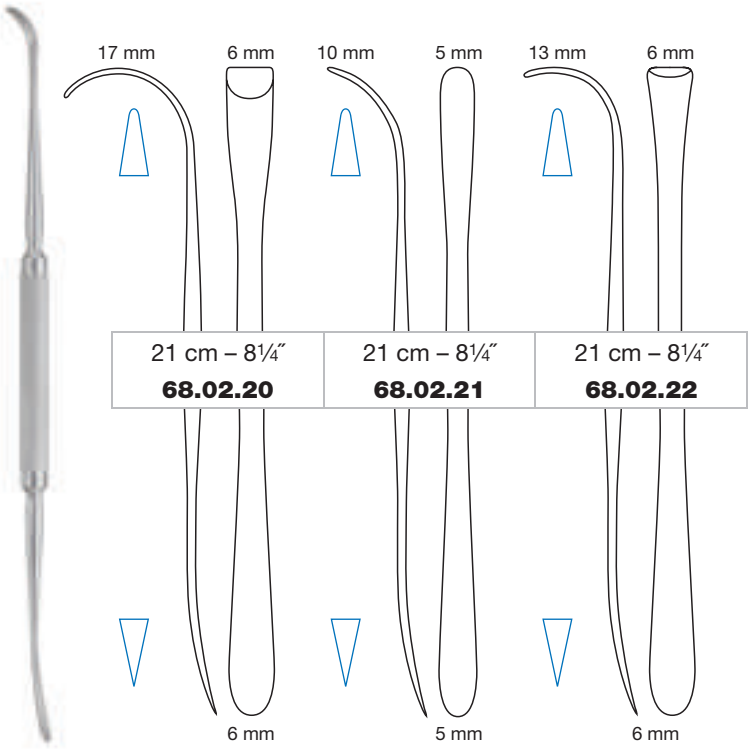
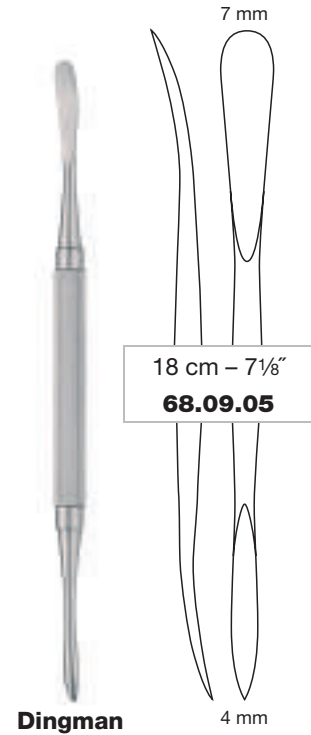
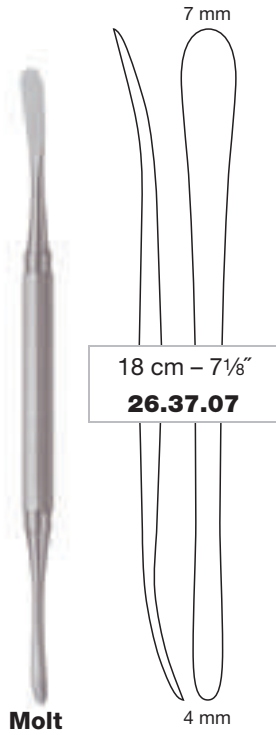

scharf
sharp
cortante
tranchant
tagliente



stumpf
blunt
roma
mousse
smussa

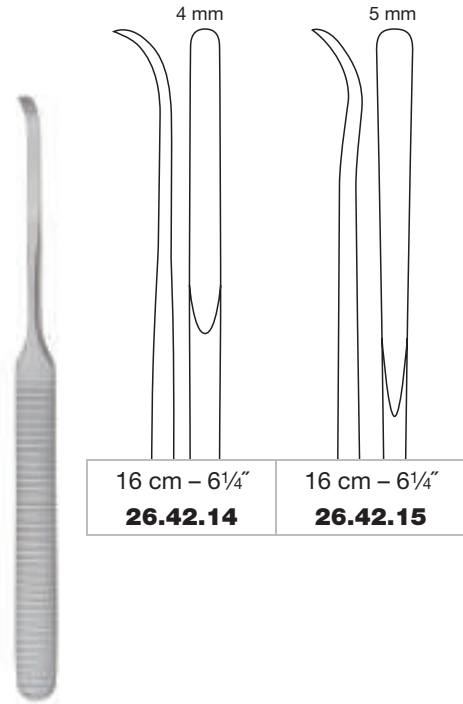

Kahre-Williger

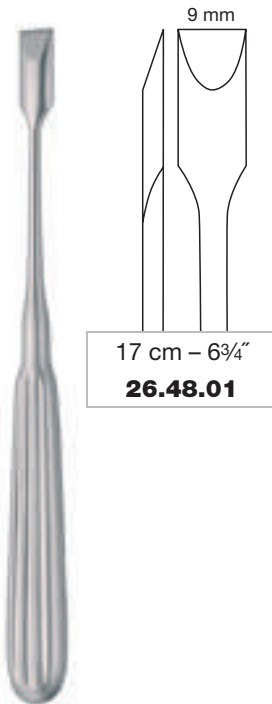
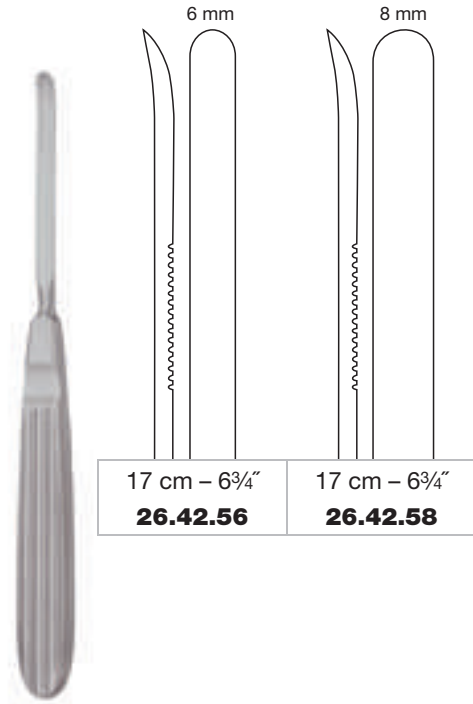

Adson

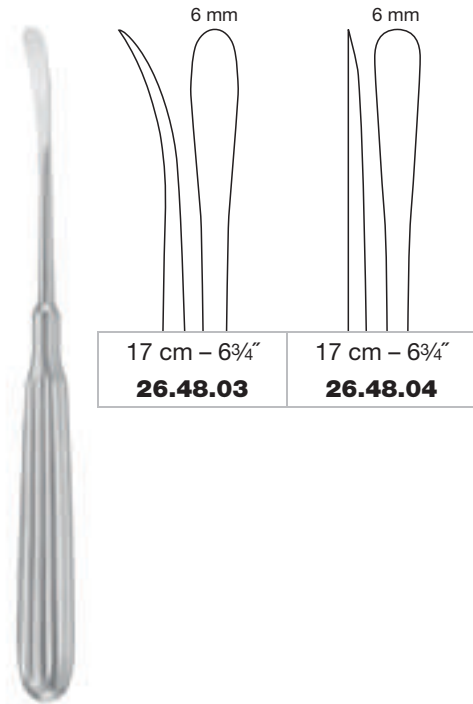

Adson



Obwegeser

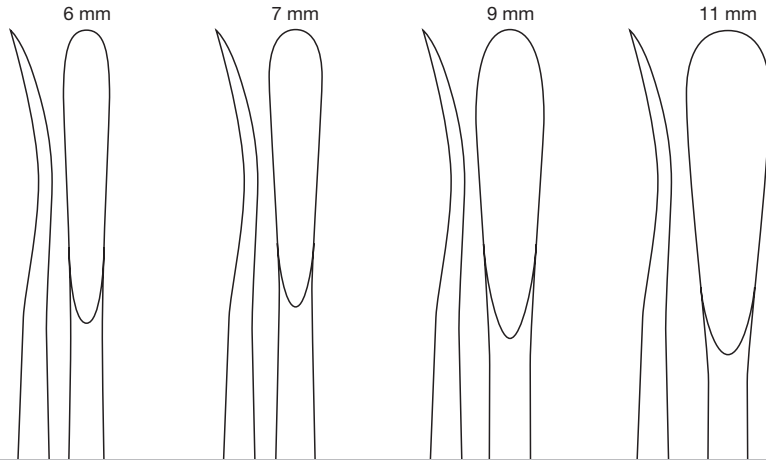

17,5 cm - 7" 68.02.01	17,5 cm - 7" 68.02.02	17,5 cm - 7" 68.02.03	17,5 cm - 7" 68.02.04
---------------------------------	---------------------------------	---------------------------------	---------------------------------



Obwegeser

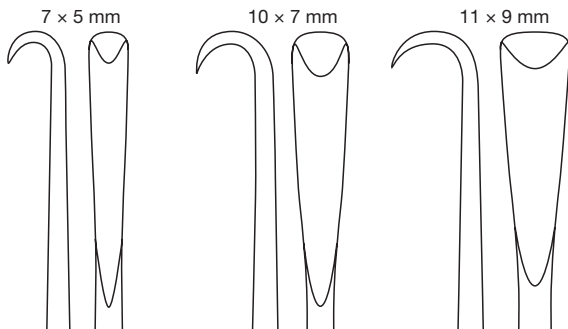

20 cm - 8" 68.02.11	20 cm - 8" 68.02.12	20 cm - 8" 68.02.13
-------------------------------	-------------------------------	-------------------------------

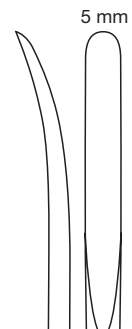

15 cm - 6" 26.40.06



König



Obwegeser

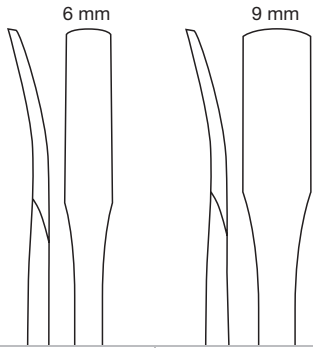

18 cm - 7 1/8"
68.02.31

18 cm - 7 1/8"
68.02.33



Obwegeser

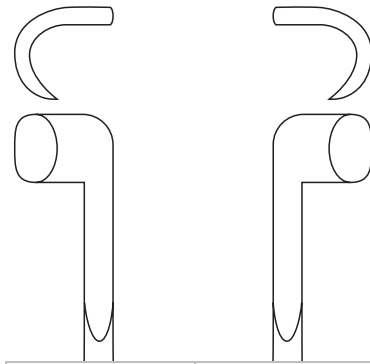

18 cm - 7 1/8"
68.02.06

18 cm - 7 1/8"
68.02.07

Linke Seite
 Left side
 Lado izquierdo
 Côté gauche
 Lato sinistro

Rechte Seite
 Right side
 Lado derecho
 Côté droite
 Lato destro

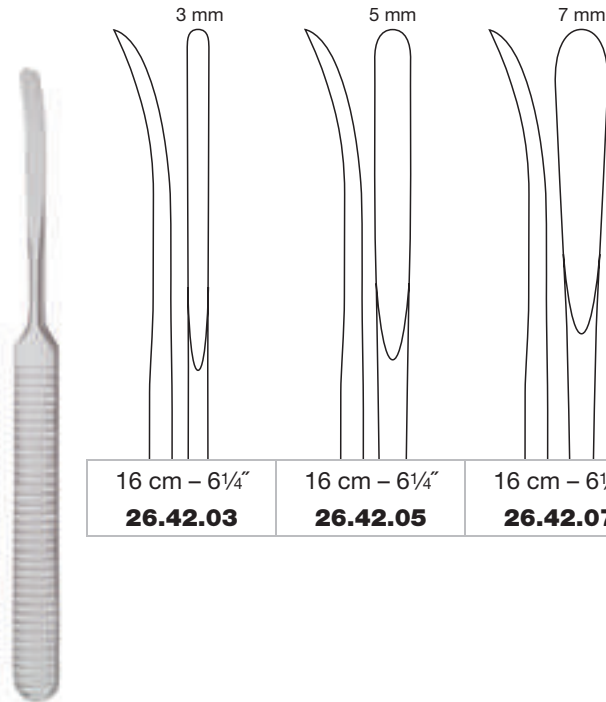

Williger

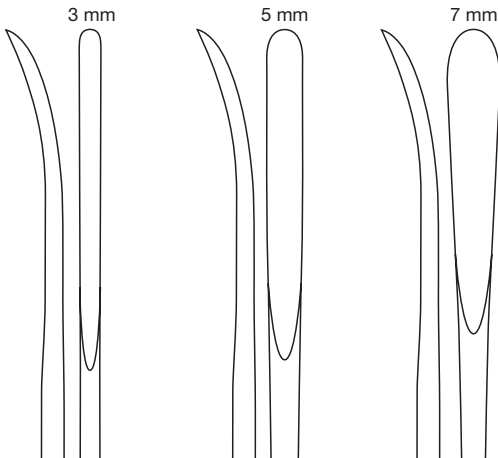

16 cm - 6 1/4"
26.42.03

16 cm - 6 1/4"
26.42.05

16 cm - 6 1/4"
26.42.07

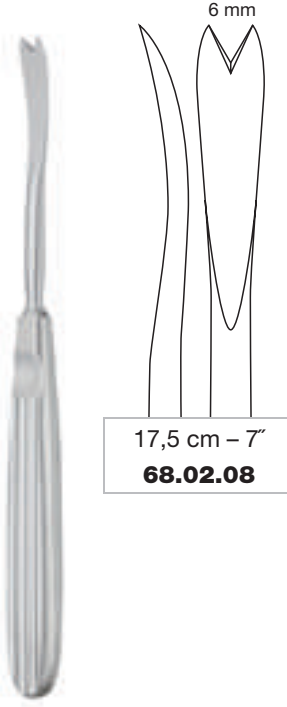

Obwegeser

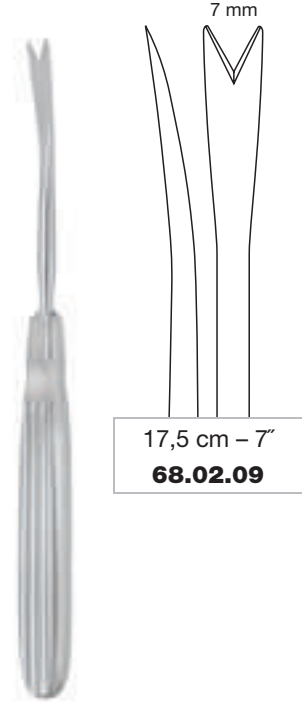

Obwegeser

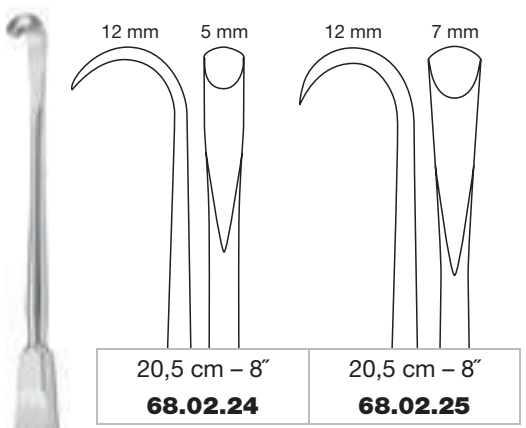

Obwegeser

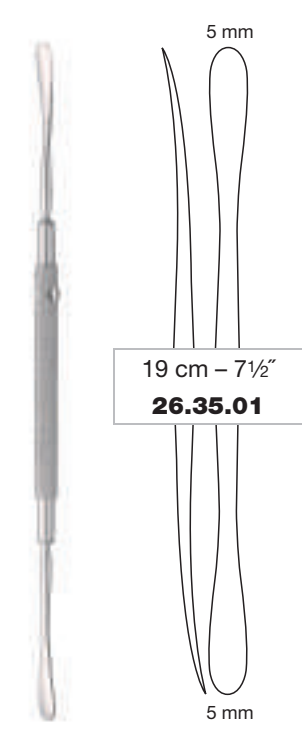

Freer

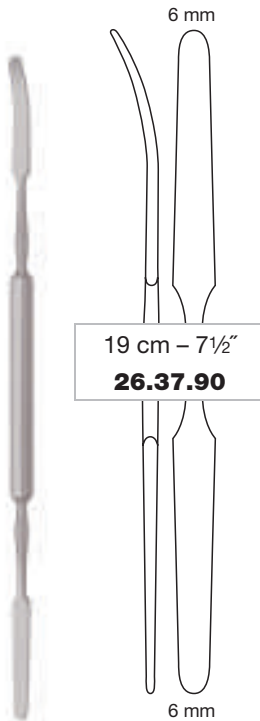

MacDonald

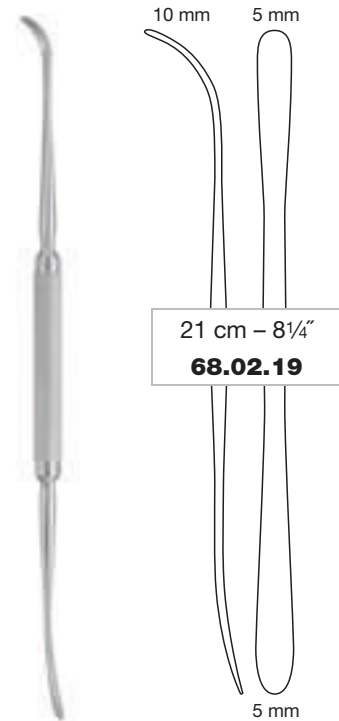

Obwegeser-Freer

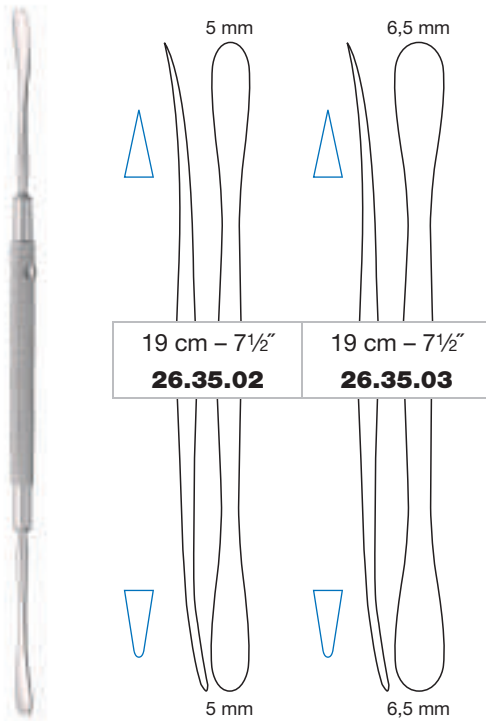

Freer

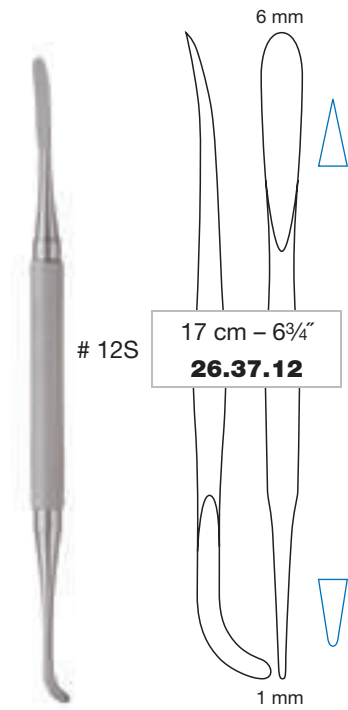

Bennet

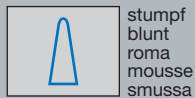
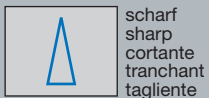



Gillies

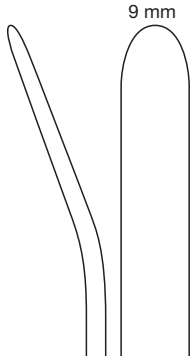

23 cm – 9"
68.45.10

für Jochbogen
for zygomatic arch
para arco cigomático
pour arcade cygomatique
per arco zigomatico



Dingman



21 cm – 8¼"
68.09.20



Adson

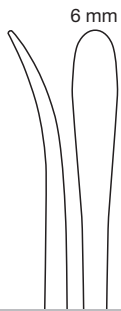

17 cm – 6¾"
26.48.02



Langenbeck

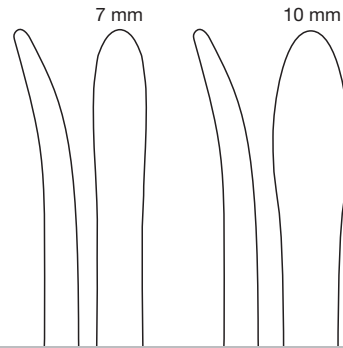

20 cm – 8"
26.29.07

20 cm – 8"
26.29.10

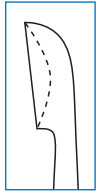

Volkmann

# 0000	# 000	# 00	# 0	# 1
17 cm - 6¾"	17 cm - 6¾"	17 cm - 6¾"	17 cm - 6¾"	17 cm - 6¾"
29.51.24	29.51.33	29.51.42	29.51.50	29.51.51

# 2	# 3	# 4	# 5	# 6
17 cm - 6¾"	17 cm - 6¾"	17 cm - 6¾"	17 cm - 6¾"	17 cm - 6¾"
29.51.52	29.51.53	29.51.54	29.51.55	29.51.56

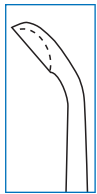

Daubenspeck

# 00	# 0	# 1	# 2
20 cm - 8"	20 cm - 8"	20 cm - 8"	20 cm - 8"
29.68.42	29.68.50	29.68.51	29.68.52



1:2.5



Hajek	21 cm – 8¼"	27.04.20	200 g	Ø 26 mm
--------------	-------------	-----------------	-------	---------

mit Kunststoffbacken (abschraubbar)
with plastic facings (unscrewable)
con frentes de material plástico (destornillables)
avec joues en matière plastique (dévissables)
con guancie di plastica (svitabili)

27.06.21

Ersatzbacken, Paar
Spare facings, pair
Frentes de repuesto, par
Joues de rechange, paire
Guancie di ricambio, paio

1:2.5



	18,5 cm – 7¼"	27.06.20	200 g	Ø 25 mm
--	---------------	-----------------	-------	---------

mit Kunststoffbacken (abschraubbar)
with plastic facings (unscrewable)
con frentes de material plástico (destornillables)
avec joues en matière plastique (dévissables)
con guancie di plastica (svitabili)

27.06.31

Ersatzbacken, Paar
Spare facings, pair
Frentes de repuesto, par
Joues de rechange, paire
Guancie di ricambio, paio

1:2.5



Mead	18 cm – 7⅞"	27.06.30	300 g	Ø 26 mm
-------------	-------------	-----------------	-------	---------

1:2.5



	26 cm – 10¼"	27.10.31	150 g	Ø 35 mm
--	--------------	-----------------	-------	---------

	26 cm – 10¼"	27.10.32	240 g	Ø 45 mm
--	--------------	-----------------	-------	---------



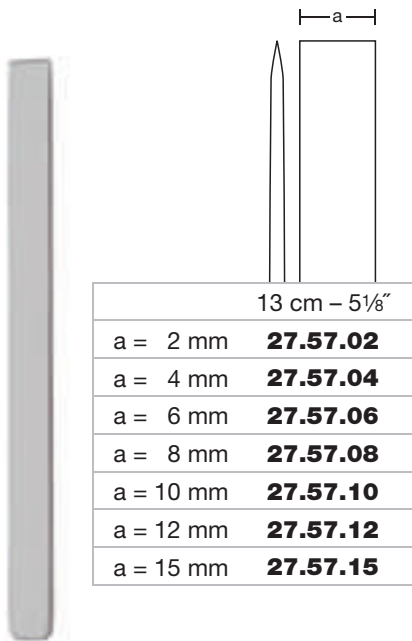

	13 cm – 5 1/8"
a = 2 mm	27.57.02
a = 4 mm	27.57.04
a = 6 mm	27.57.06
a = 8 mm	27.57.08
a = 10 mm	27.57.10
a = 12 mm	27.57.12
a = 15 mm	27.57.15

Mini-Lambotte

Satz komplett in Rolltasche
 Set complete in canvas roll
 Juego completo en bolsa de lona
 Série complète en housse de toile
 Serie completa in custodia di tela



27.57.90

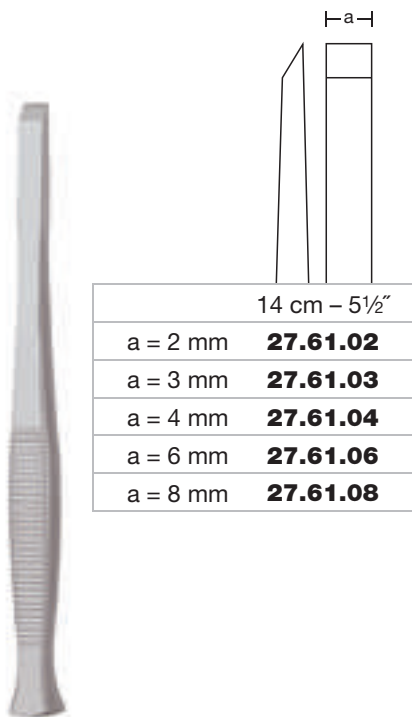

	14 cm – 5 1/2"
a = 2 mm	27.61.02
a = 3 mm	27.61.03
a = 4 mm	27.61.04
a = 6 mm	27.61.06
a = 8 mm	27.61.08

Partsch

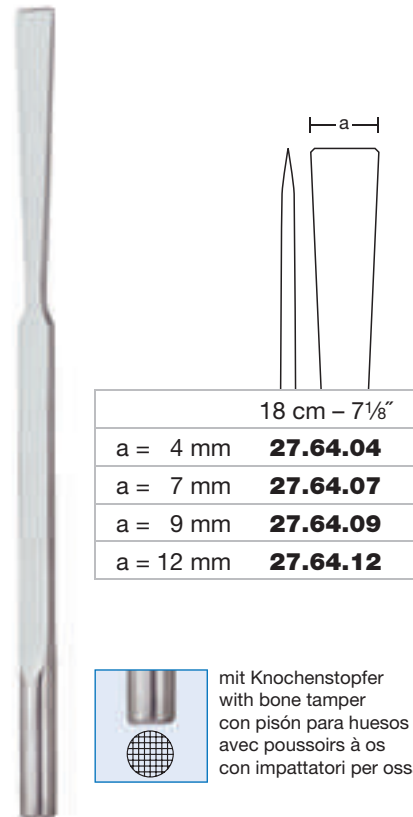

	18 cm – 7 1/8"
a = 4 mm	27.64.04
a = 7 mm	27.64.07
a = 9 mm	27.64.09
a = 12 mm	27.64.12

Cottle-Medicon

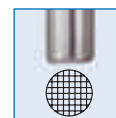

mit Knochenstopfer
 with bone tamper
 con pisón para huesos
 avec poussoirs à os
 con impattatori per ossa



Flachmeißel und Osteotome
Chisels and Osteotomes
Cinceles y osteótomos
Ciseaux burins et ostéotomes
Scalpelli e osteotomi



Lambotte

24 cm – 9½"	
a = 4 mm	28.94.04
a = 6 mm	28.94.06
a = 8 mm	28.94.08
a = 10 mm	28.94.10
a = 12 mm	28.94.12
a = 15 mm	28.94.15
a = 20 mm	28.94.20
a = 25 mm	28.94.25
a = 30 mm	28.94.30
a = 40 mm	28.94.40
a = 44 mm	28.94.44
a = 50 mm	28.94.50

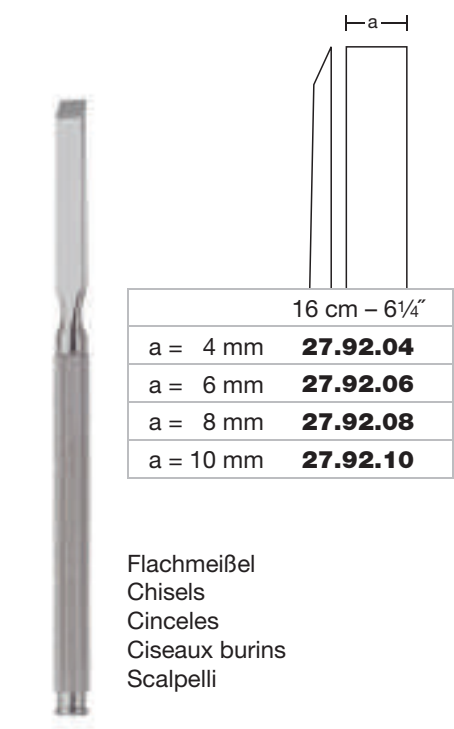

Brünings

16 cm – 6¼"	
a = 4 mm	27.92.04
a = 6 mm	27.92.06
a = 8 mm	27.92.08
a = 10 mm	27.92.10

Flachmeißel
 Chisels
 Cinceles
 Ciseaux burins
 Scalpelli

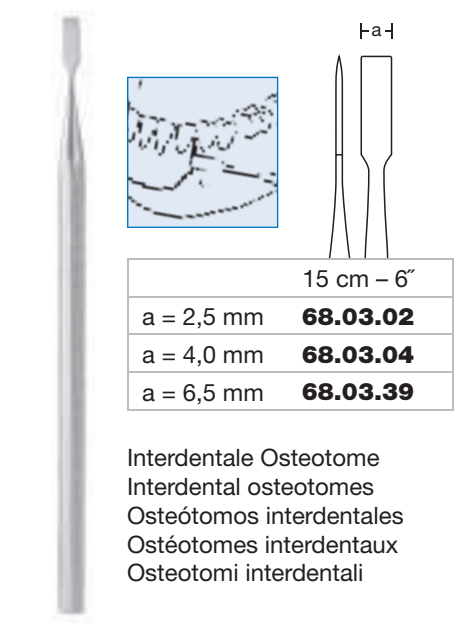

Obwegeser

15 cm – 6"	
a = 2,5 mm	68.03.02
a = 4,0 mm	68.03.04
a = 6,5 mm	68.03.39

Interdentale Osteotome
 Interdental osteotomes
 Osteótomos interdetales
 Ostéotomes interdetaux
 Osteotomi interdentali



	21,5 cm – 8½"
a = 7 mm	68.03.07
a = 10 mm	68.03.10

▲
▲

Spaltosteotome
 Splitting osteotomes
 Osteótomos hendedores
 Ostéotomes à fendre
 Osteotomi per splittaggio osseo

Obwegeser

	22 cm – 8¾"
a = 8 mm	68.03.12
a = 12 mm	68.03.13
a = 16 mm	68.03.14

▲
▲

Keilosteotome
 Wedge osteotomes
 Osteótomos de cuña
 Ostéotomes cunéiformes
 Osteotomi a forma di cuneo

Obwegeser

	22 cm – 8¾"
a = 8 mm	68.03.16
a = 12 mm	68.03.17
a = 16 mm	68.03.18

▲
▲

Blattosteotome
 Blade osteotomes
 Osteótomos de hoja
 Ostéotomes en lame
 Osteotomi a forma di lama

Obwegeser

	23 cm – 9"
a = 8 mm	68.03.31
a = 10 mm	68.03.30
a = 11 mm	68.03.32

▲
▲

Tuber Osteotome
 Pterygoid osteotomes
 Osteótomos pterigoideo
 Ostéotomes pterygoïde
 Osteotomi pterigoideo

Obwegeser



**Osteotome
Osteotomes
Osteótomos
Ostéotomes
Osteotomi**



flexibel
flexible
flexible
flexible
flessibile

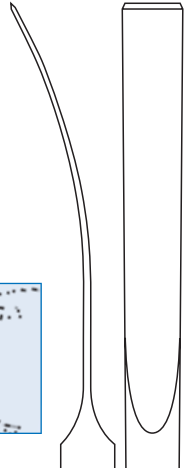

	21 cm – 8 1/4"
a = 8 mm	68.03.34
a = 10 mm	68.03.35

Obwegeser

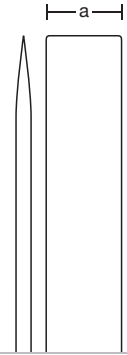

	20 cm – 8"
a = 10 mm	67.32.80

Knochenhebel und Spaltosteotom
Bone lever and splitting osteotome
Elevador óseo y osteótomo hendedor
Lever à os et ostéotome à fendre
Elevatore per ossa e osteotomo per splittaggio

Cottle

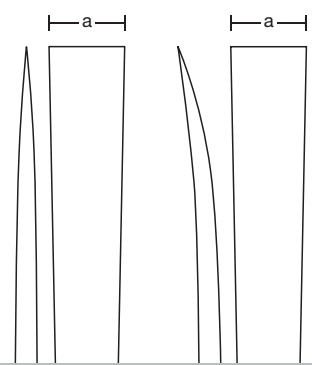

	20,5 cm – 8"	20,5 cm – 8"
a = 10 mm	68.03.50	68.03.51
a = 15 mm	68.03.52	68.03.53

Tessier

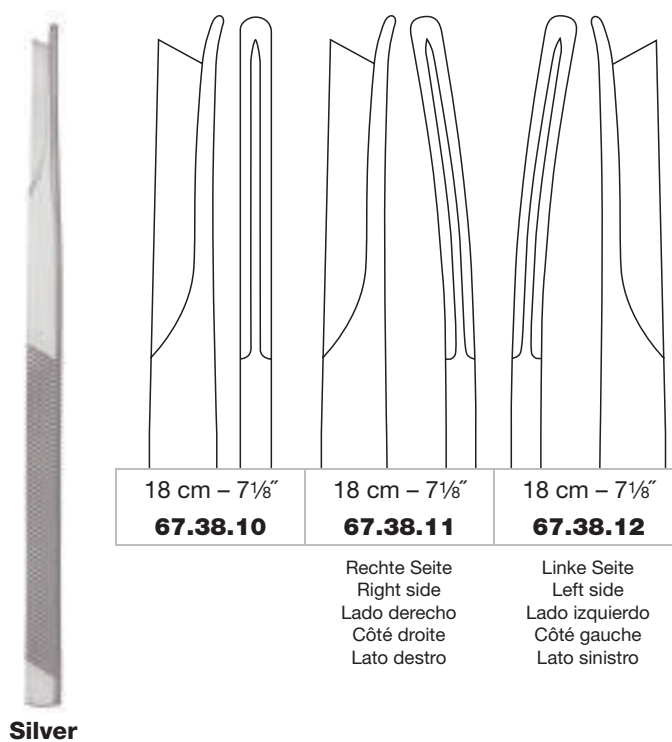
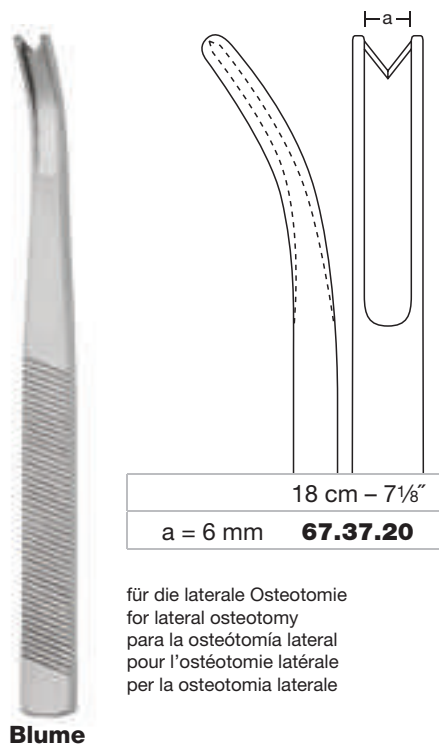
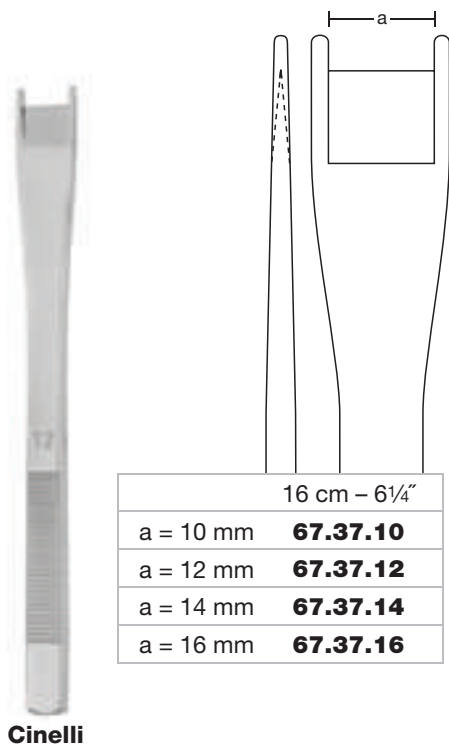



Nasenseptum-Osteotome und Mobilisator
Nasal Septum Osteotomes and Mobilizer
Osteótomos para el tabique nasal y mobilizador
Ostéotomes pour cloison nasale et mobilisateur
Osteotomi per setto nasale e mobilizzatore

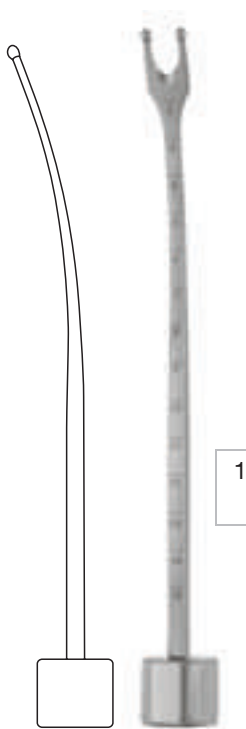

Obwegeser

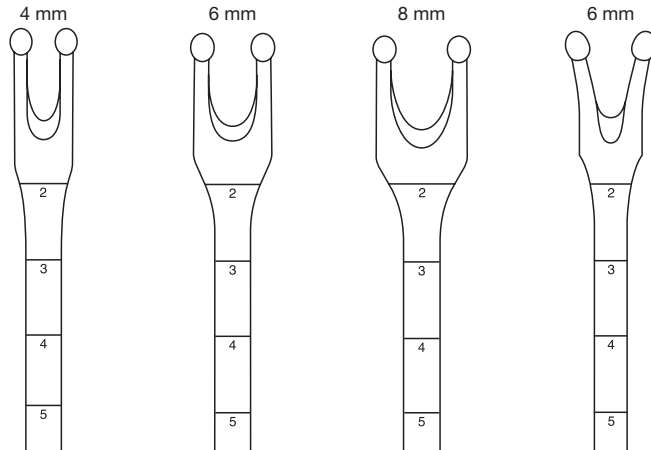

18,5 cm – 7¼"	18,5 cm – 7¼"	18,5 cm – 7¼"	18,5 cm – 7¼"
68.03.71	68.03.72	68.03.73	68.03.76



Maxilla-Mobilisator
 Maxilla mobilizer
 Mobilizador maxilar
 Mobilisateur pour maxillaire
 Mobilizzatore per mascella

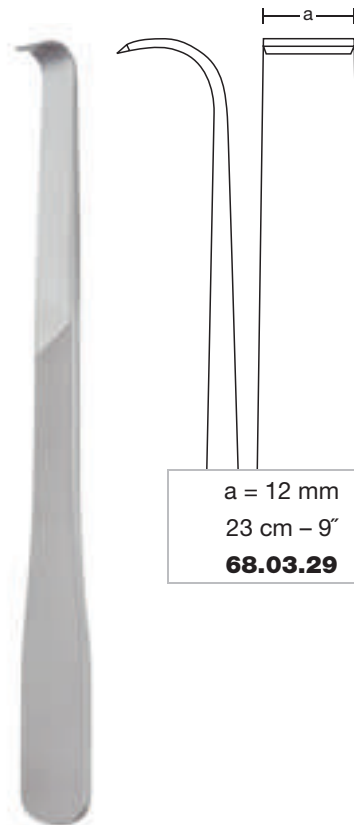
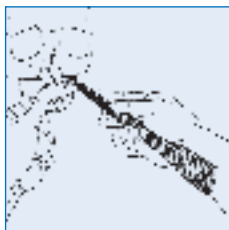

Obwegeser

a = 12 mm
 23 cm – 9"

68.03.29

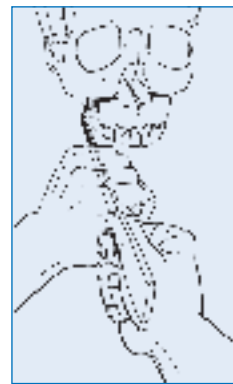

Linke Seite
 Left side
 Lado izquierdo
 Côté gauche
 Lato sinistro

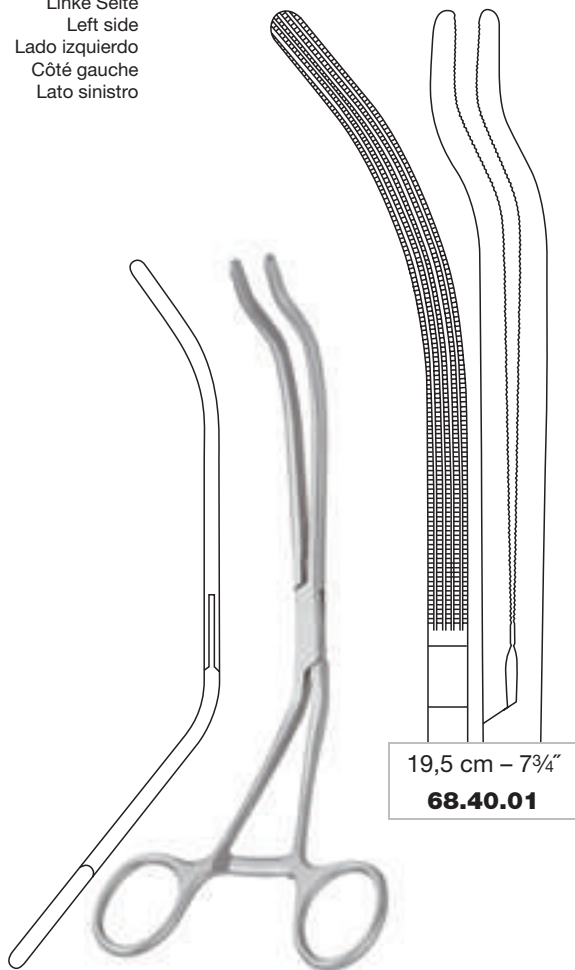

19,5 cm - 7¾"
68.40.01

Obwegeser

Rechte Seite
 Right side
 Lado derecho
 Côté droite
 Lato destro

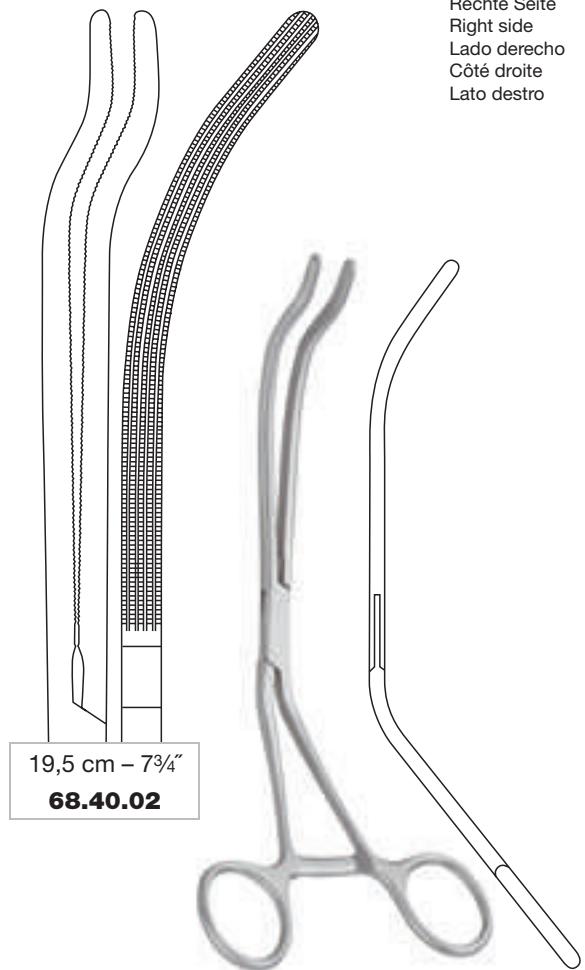

19,5 cm - 7¾"
68.40.02

Obwegeser



Mobilisierhaken und Repositionszangen
Mobilizing Retractors and Reposition Forceps
Separadores de movilización y pinzas para reposicionar
Crochets à mobilisation et pinces à réposition
Divaricatori per mobilizzazione e pinze per riposizione



für Unterkiefer
 for lower jaw
 para mandíbula inferior
 pour mâchoire inférieure
 per mascella inferiore

Tessier

Mobilisierhaken
 Mobilizing retractors
 Separadores de movilización
 Crochets à mobilisation
 Divaricatori per mobilizzazione

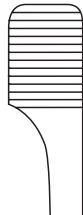

68.51.01
 Linke Seite
 Left side
 Lado izquierdo
 Côté gauche
 Lato sinistro



68.51.02
 Rechte Seite
 Right side
 Lado derecho
 Côté droite
 Lato destro



für Unterkiefer
 for lower jaw
 para mandíbula inferior
 pour mâchoire inférieure
 per mascella inferiore

Tessier



Rowe

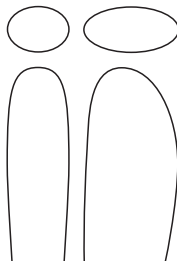

24 cm – 9½"
68.50.01

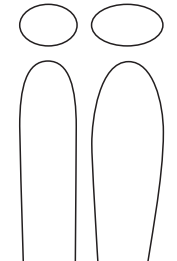

23,5 cm – 9¼"
68.50.03

Repositionszangen
 Reposition forceps
 Pinzas para reposicionar
 Pincès à réposition
 Pinze per riposizione

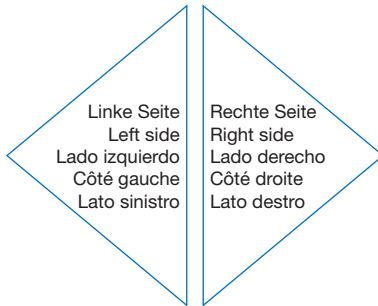

für Oberkiefer
 for upper jaw
 para mandíbula superior
 pour mâchoire supérieure
 per mascella superiore

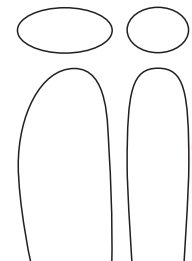

24 cm – 9½"
68.50.02

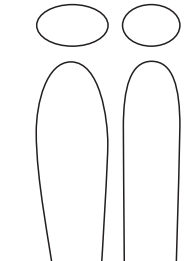

23,5 cm – 9¼"
68.50.04



Rowe



Positionierer
 Positioner
 Posicionador
 Positionneur
 Posizionatore

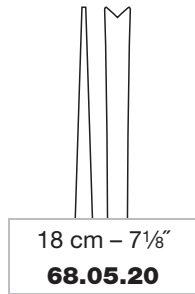

18 cm - 7 1/8"
68.05.20

Wangerin

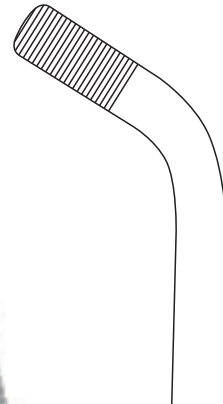

17 cm - 6 3/4"
68.40.08

Marchac

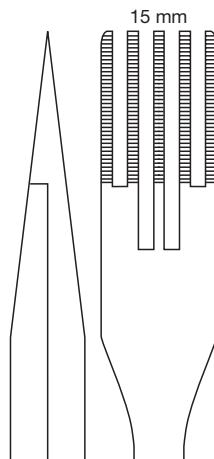

22 cm - 8 3/4"
68.40.04

Obwegeser

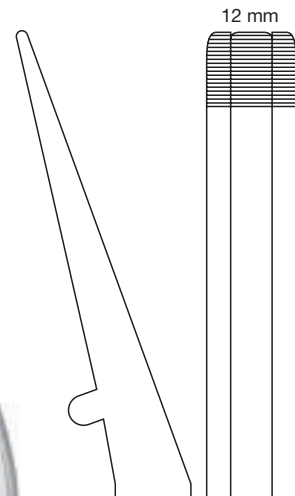

12 mm
 23,5 cm - 9 1/4"
68.40.10

Smith



13,5 cm – 5 $\frac{3}{8}$ "
35.11.13

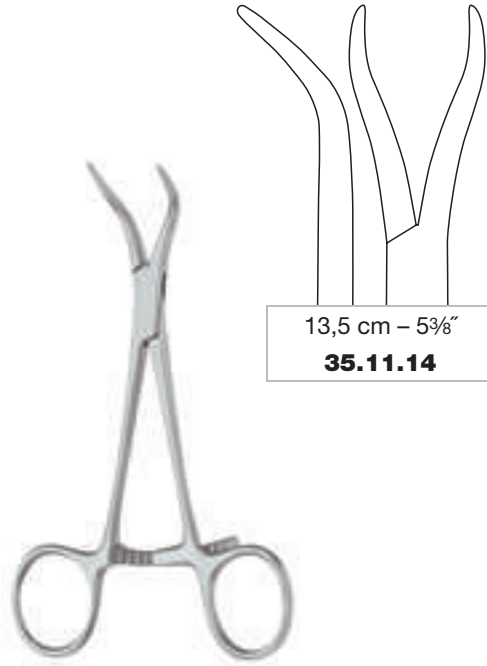

13,5 cm – 5 $\frac{3}{8}$ "
35.11.14

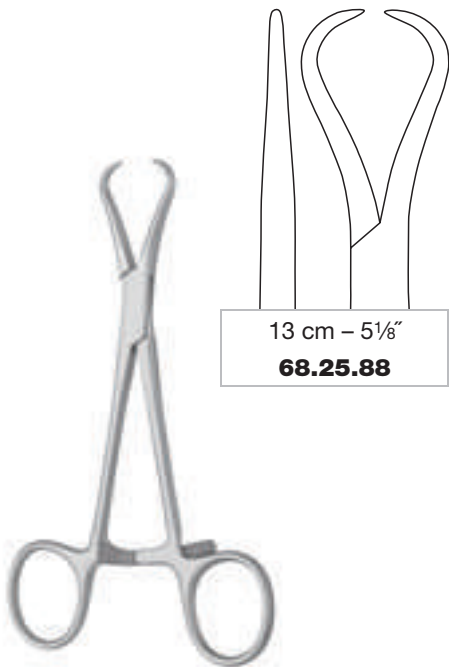

13 cm – 5 $\frac{1}{8}$ "
68.25.88

Steinhäuser



17,5 cm – 7"
68.25.89

Steinhäuser





19 cm - 7½"
35.15.18

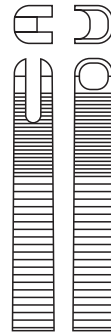

19 cm - 7½"
35.15.19

Dingman



Semb

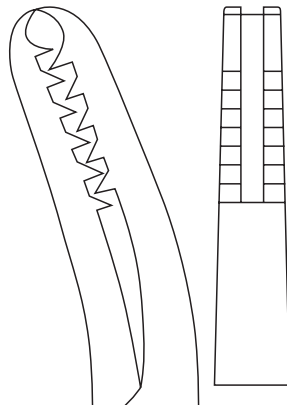

20 cm - 8"
35.24.20

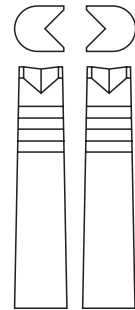

20 cm - 8"
35.20.20



Knochensplitterzangen und Hohlmeißelzangen
Bone Cutting Forceps and Bone Rongeurs
Pinzas cortantes para huesos y pinzas gubias
Pinces coupantes à os et pince-gouges
Pinze ossivore e pinze sgorbie



Ruskin-Liston



18 cm - 7 1/8"
33.56.18



18 cm - 7 1/8"
33.57.18



McIndoe



18 cm - 7 1/8"
33.59.17



Hohlmeißelzangen
 Bone rongeurs
 Pinzas gubias
 Pince-gouges
 Pinze sgorbie



14 cm - 5 1/2"
30.07.14



14 cm - 5 1/2"
30.07.15



Marquardt



20 cm - 8"
31.11.13

Hohlmeißelzange
 Bone rongeur
 Pinza gubia
 Pince-gouge
 Pinza sgorbia



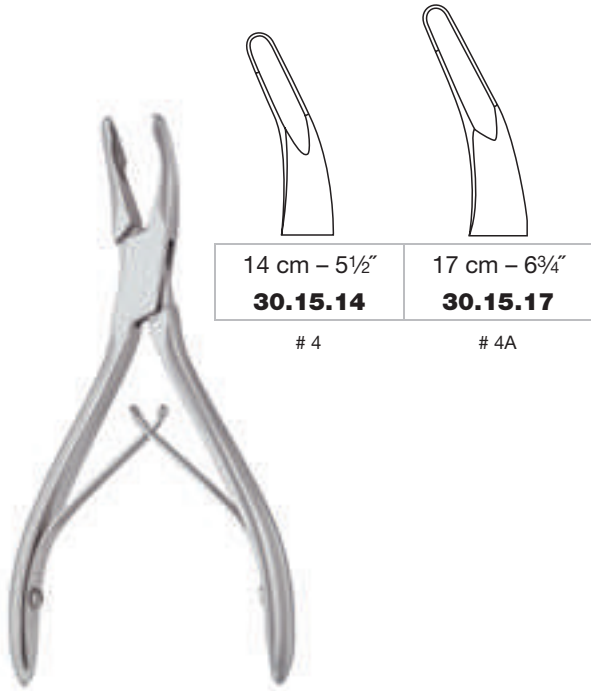

Mead

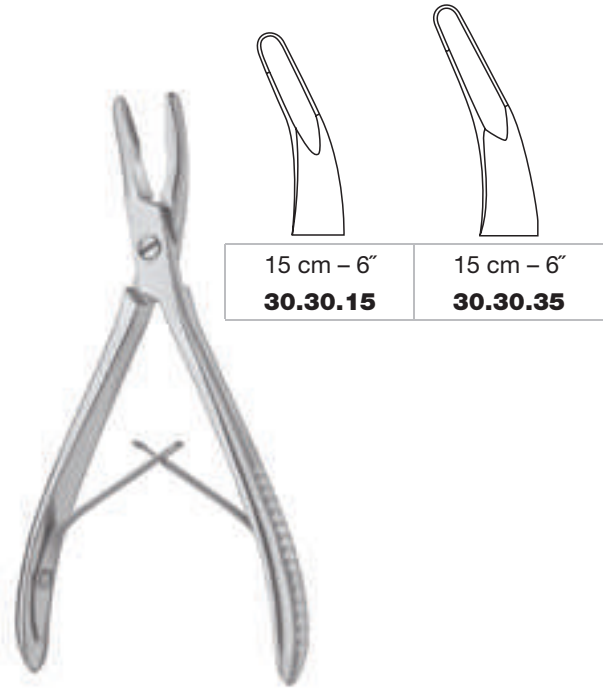

Luer

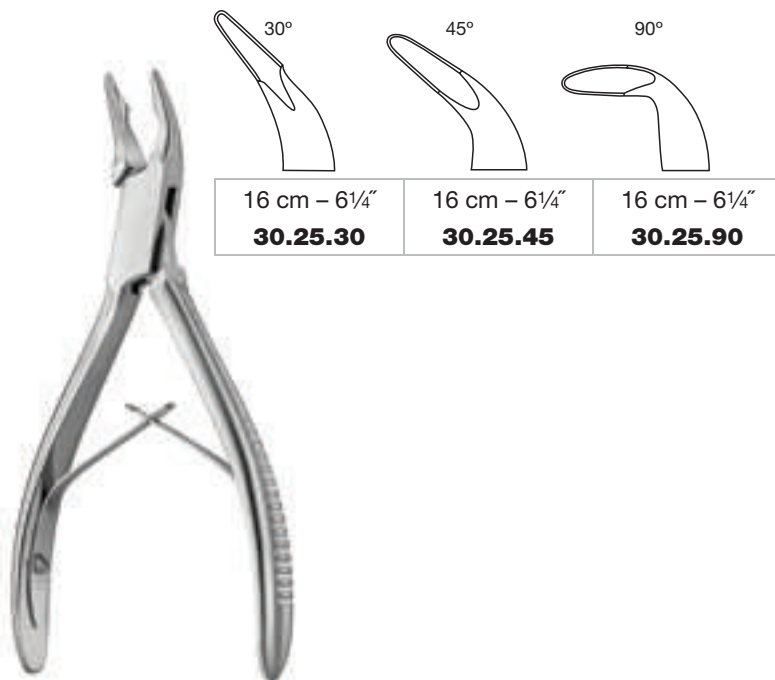

Blumenthal



Beyer



Hohlmeißelzangen
Bone Rongeurs
Pinzas gubias
Pinces-gouges
Pinze sgorbie

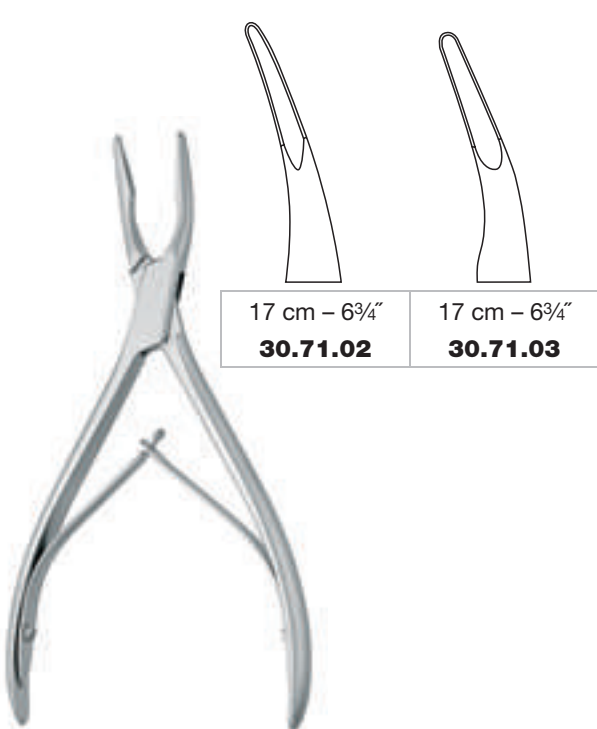

17 cm - 6¾"	17 cm - 6¾"
30.71.02	30.71.03

Beyer

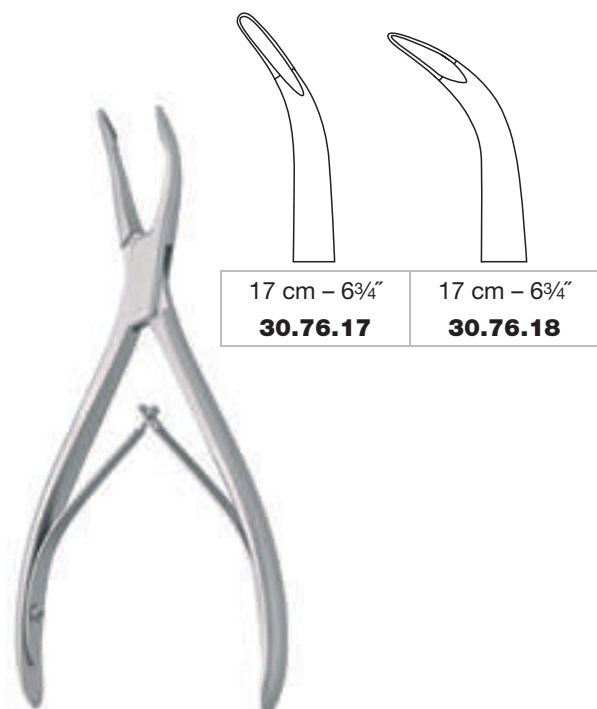

17 cm - 6¾"	17 cm - 6¾"
30.76.17	30.76.18

Stellbrink

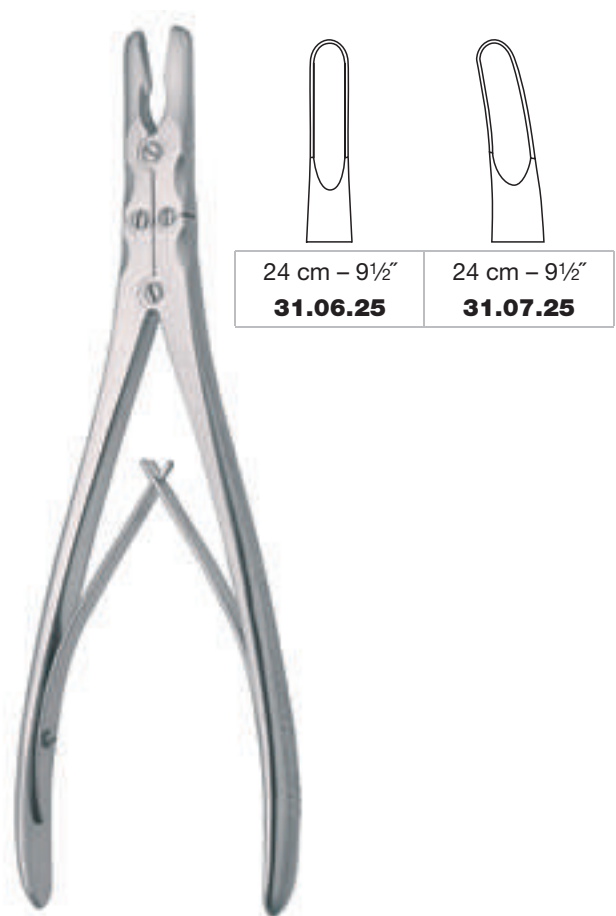

24 cm - 9½"	24 cm - 9½"
31.06.25	31.07.25

Ruskin





Ruskin-Mini

15 cm - 6" 31.04.02	15 cm - 6" 31.04.03	15 cm - 6" 31.05.02	15 cm - 6" 31.05.03



Ruskin

18 cm - 7 1/8" 31.06.05	18 cm - 7 1/8" 31.07.05





Zaufal-Jansen

18 cm - 7 1/8" 31.11.05



Siebbeinzangen
Ethmoid Bone Forceps
Pinzas para hueso etmoidal
Pinces pour os ethmoïdal
Pinze per osso etmoidale

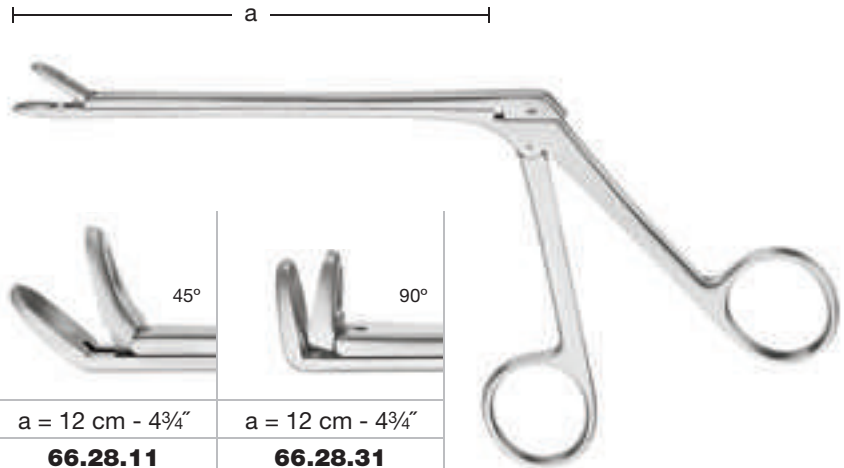

mit normalem Schaft
 with normal shaft
 con vástago normal
 à tige normale
 con asta normale

	Maulbreite Jaw width Ancho de boca Largeur de mors Larghezza dei morsi	a		
			 45°	 90°
		a = 12 cm - 4¾"	a = 12 cm - 4¾"	a = 12 cm - 4¾"
# 1	3,0 mm	66.28.01	66.28.11	66.28.31
# 2	3,6 mm	66.28.02	66.28.12	66.28.32
# 3	4,2 mm	66.28.03	66.28.13	66.28.33
# 4	4,8 mm	66.28.04	66.28.14	66.28.34
# 5	5,6 mm	66.28.05		



Weil-Blakesley

mit schlankem Schaft
 with slim shaft
 con vástago delgado
 à tige élancée
 con asta sottile

	Maulbreite Jaw width Ancho de boca Largeur de mors Larghezza dei morsi	a	
			 45°
		a = 12 cm - 4¾"	a = 12 cm - 4¾"
# 1	3,0 mm	66.28.71	66.28.81
# 2	3,6 mm	66.28.72	66.28.82
# 3	4,2 mm	66.28.73	66.28.83
# 4	4,8 mm	66.28.74	66.28.84
# 5	5,6 mm	66.28.75	

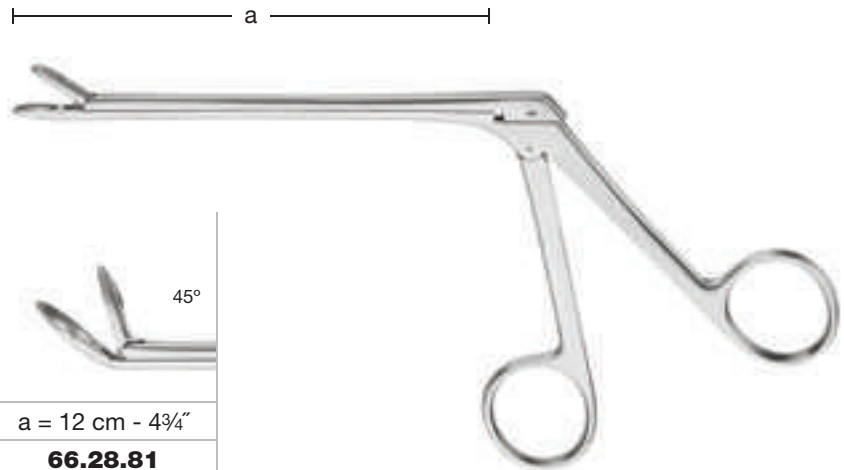

Weil-Blakesley



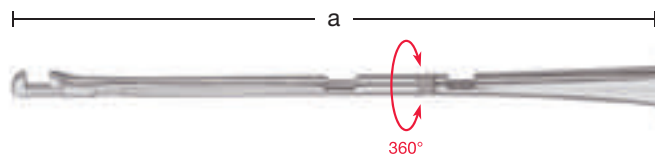





Stanzbreite Jaw width Ancho de boca Largeur de mors Larghezza dei morsi	
D 3 mm	a = 16 cm - 6 1/2" 66.38.10



Stanze, drehbar
 Rongeur, rotatable
 Pinza saca-bocada, giratoria
 Pince emporte-pièce, rotatif
 Pinza tagliante, girevole

Hajek-Kofler



Ø 3 mm 	Ø 5 mm 
16 cm - 6 1/4" 27.95.03	16 cm - 6 1/4" 27.95.05
Ø 7 mm 	Ø 9 mm 
16 cm - 6 1/4" 27.95.07	16 cm - 6 1/4" 27.95.09



3,0 mm 	3,5 mm 
12 cm - 4 3/4" 27.95.11	12 cm - 4 3/4" 27.95.12

Blutstillungsmeißel
 Hemostatic chisels
 Cinceles para hemostasia
 Ciseaux burins pour hémostase
 Scalpelli per emostasi

Passow



Stahllineale (rostfrei)
 Rulers (stainless steel)
 Reglas de acero (inoxidable)
 Règles en acier (inoxydable)
 Righelli in acciaio (inossidabile)

15 cm – 6"	44.37.15
20 cm – 8"	44.37.20
30 cm – 11¾"	44.37.30
50 cm – 19¾"	44.37.50

graduiert in mm und Zoll
 graduated in mm and inches
 graduado en mm y pulgadas
 graduée en mm et pouces
 graduato in mm e pollici

Röntgen-Lineal (rostfrei)
 X-Ray ruler (stainless steel)
 Regla radiografica (inoxidable)
 Règle pour radiographie (inoxydable)
 Righello per radiografia (inossidabile)



mit Kerben und graduiert in mm
 with notches and graduated in mm
 con muesca y graduado en mm
 avec encoches et graduée en mm
 con incavature e graduato in mm



50 cm – 19¾"	44.37.95
--------------	-----------------



Winkelmesser
 Flexometer
 Goniómetro
 Goniomètre
 Goniometro

24 cm – 9½"	44.38.10
-------------	-----------------

zusammenlegbar
 fold up
 plegable
 pliable
 pieghevole

Möltgen



Knochenmesszirkel
 Bone measuring dividers
 Compás para hueso
 Compas à os
 Compasso per ossa

19,5 cm – 7¾"	44.38.40
---------------	-----------------



20 mm



8 cm – 3 1/8"
60.00.40

Castroviejo

40 mm



9 cm – 3 1/2"
60.00.41

Castroviejo

40 mm



18 cm – 7 1/8"
60.00.42

Castroviejo-Epker

40 mm



18 cm – 7 1/8"
60.00.43

Castroviejo-Epker



Messbereich
 Measuring range
 Alcance de medición
 Etendue de mesure
 Campo di misura



Referenz-Pin für die "Le Fort I"-Osteotomie
Reference Pin for "Le Fort I" Osteotomy
Perno de referencia para osteotomía de "Le Fort I"
Pivot de référence pour ostéotomie de "Le Fort I"
Perno di referenza per osteotomia di "Le Fort I"

KRETSCHMER REFERENCE PIN

Referenz-Pin und Halterung
 Reference pin and holder
 Perno de referencia y soporte
 Pivot de référence et support
 Perno di referenza e sostegno

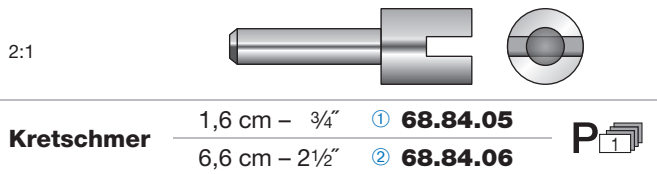
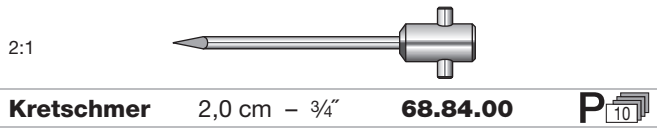

Kompatibel mit Chirurgiehandstücke:
 Compatible with surgical hand pieces:
 Compatible con pieza de mano quirúrgica:
 Compatible avec pièce à main chirurgicale:
 Compatibile con manipoli chirurgici:

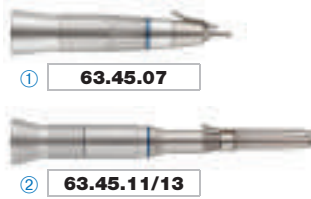

Siebvorschlag bestehend aus:
 Set suggestions consisting of:
 Proposición de juego compuesto por:
 Proposition pour jeu se composant de:
 Proposta di set composto da:

68.84.00	Referenz-Pin Reference pin Perno de referencia Pivot de référence Perno di referenza
68.84.05	Halterung für Referenz-Pin Holder for reference pin Soporte para perno de referencia Support pour pivot de référence Sostegno per perno di referenza
44.38.40	Knochenmesszirkel Bone measuring dividers Compás para hueso Compas à os Compasso per ossa
44.37.20	Stahllineal (rostfrei) Ruler (stainless steel) Regla de acero (inoxidable) Règle en acier (inoxydable) Righello in acciaio (inossidabile)

SERVOTRONIC II

siehe Seite 130
 see page 130
 véase página 130
 voir page 130
 vedi pagina 130



- ▶ Exakte Ermittlung der vertikalen Dimensionen durch festen Referenzpunkt
- ▶ Keine Irritationen des Referenzpunktes während der OP
- ▶ Einfache und exakte Endkontrolle der gewünschten vertikalen Position vor und während der Fixation
- ▶ Precise determination of vertical dimensions by a fixed reference point
- ▶ No irritation of the reference point during surgery
- ▶ Easy and precise final checking of the desired vertical position before and during fixation
- ▶ Determinación precisa de las dimensiones verticales gracias al punto de referencia fijo
- ▶ Ningún tipo de irritación del punto de referencia durante la intervención quirúrgica
- ▶ Sencillez y precisión de los controles finales de la posición vertical deseada, antes y durante la fijación
- ▶ Détermination précise des dimensions verticales grâce au point de référence fixe
- ▶ Aucune irritation du point de référence pendant l'intervention chirurgicale
- ▶ Simplicité et précision des contrôles finaux de la position verticale désirée, avant et pendant la fixation
- ▶ Determinazione precisa delle dimensioni verticali grazie al punto di referenza fisso
- ▶ Nessuna irritazione del punto di referenza durante l'intervento chirurgico
- ▶ Controllo finale semplice e preciso della posizione verticale desiderata, prima e durante la fissazione

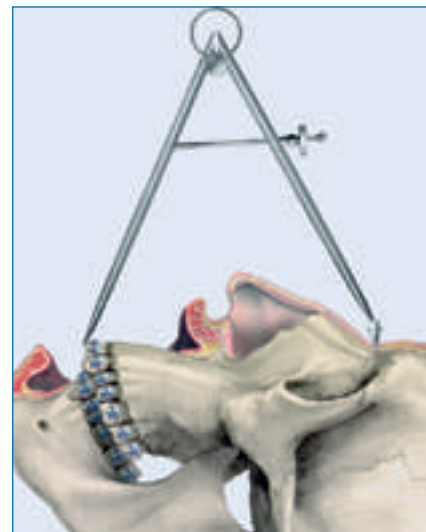

P_X Verpackungseinheit "X" Stück
 Packing unit "X" pieces
 Paquete de "X" unidades
 Emballage de "X" pièces
 Confezione da "X" pezzi



Drahtbogen
 Arch bar
 Arco de alambre
 Arc en fil
 Arco di filo

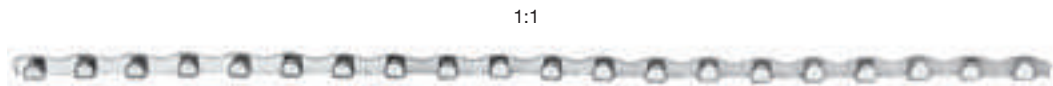

Erich 14 cm – 5½" **68.15.10** P₁₂

Drahtbügelschiene
 Arch bar
 Arco de alambre
 Arc en fil
 Arco di filo

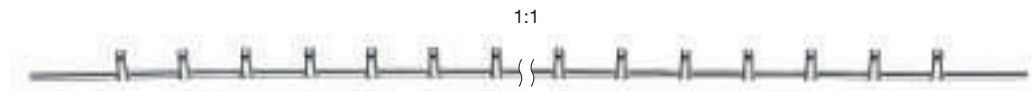

Dautrey 15 cm – 6" **68.04.93** P₁

Drahtbogen
 Arch bar
 Arco de alambre
 Arc en fil
 Arco di filo



Erich **68.15.05** 1 m

Knochendrähte, weich
 Bone wires, soft
 Alambre para huesos, dulce
 Fils à os, souple
 Fili per ossa, dolce



10 m	76.01.03	● Ø 0,3 mm	(29 G)
10 m	76.01.04	● Ø 0,4 mm	(27 G)
10 m	76.01.05	● Ø 0,5 mm	(25 G)

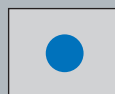

Drahtstärke
 Thickness of wire
 Grosor del alambre
 Epaisseur du fil
 Spessore del filo



Luniatschek

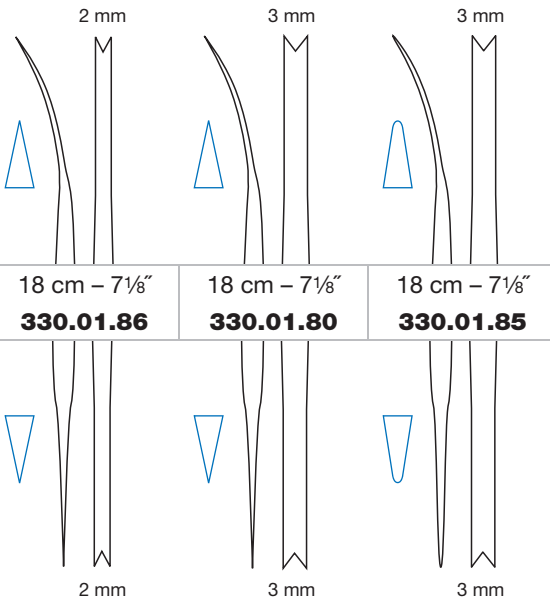

Flachzange
 Flat nose pliers
 Alicata plano
 Pince plate
 Tenaglia piatta



14 cm – 5 1/2"
14.46.14

Drahtpositionierer
 Wire pusher
 Instrumento para posicionar alambre
 Positionneur à fil
 Posizionatore per filo



Merston



14,5 cm – 5 3/4"
68.15.50



scharf
 sharp
 cortante
 tranchant
 tagliente



stumpf
 blunt
 roma
 mousse
 smussa



13 cm – 5 1/8"
68.04.73

Drahtdrehklemme
 Wire twister
 Pinza para torcer alambre
 Pince à torsader le fil
 Pinza per torcere fili

Obwegeser "HM"



15,5 cm – 6 1/8"
68.04.76

Drahtösenklemme
 Wire loop forceps
 Pinza para ojetes de alambre
 Pince pour œillets en fil métallique
 Pinza occhiello per filo metallico

Obwegeser



Ahlen
 Awls
 Leznas
 Alènes
 Punteruoli



14 cm – 5 1/2"
68.04.05

für Unterkiefer
 for lower jaw
 para mandíbula inferior
 pour mâchoire inférieure
 per mascella inferiore

Obwegeser



18 cm – 7 1/8"
68.04.15

für Oberkiefer
 for upper jaw
 para mandíbula superior
 pour mâchoire supérieure
 per mascella superiore

Obwegeser



23 cm – 9"
68.04.10

für Jochbogen
 for zygomatic arch
 para arco cigomático
 pour arcade cygomatique
 per zigomo

Obwegeser



"HM"

Hartmetall
 Tungsten carbide
 Carburo de tungsteno
 Carbure de tungstène
 Carburo di tungsteno



Drahtschneidezangen
Wire Cutting Pliers
Alicate para cortar alambre
Pinces coupe-fils
Pinze per tagliare fili

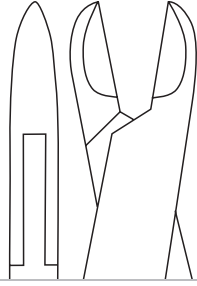

12 cm – 4¾"
14.30.11

Ø = 0,6 mm
 Ø = 1,0 mm

“HM”

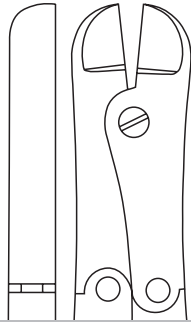

13 cm – 5⅛"
14.30.13

Ø = 1,2 mm
 Ø = 1,6 mm

“HM”

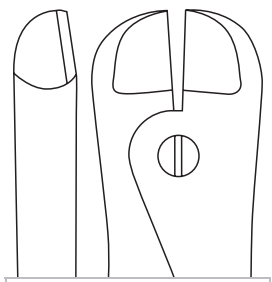

17,5 cm – 7"
14.30.17

Ø = 1,6 mm
 Ø = 2,0 mm

“HM”

Drahtschere
 Wire cutting scissors
 Tijera para cortar alambre
 Ciseaux coupe-fil
 Forbice per fili d'acciaio

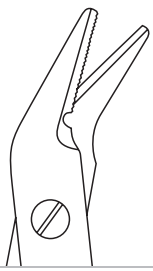

12 cm – 4¾"
14.23.62

Ø = 0,3 mm
 Ø = 0,8 mm

Universal “HM”

 eine Schneide gezahnt
 one blade serrated
 una hoja dentada
 une lame dentelée
 una lama dentellata



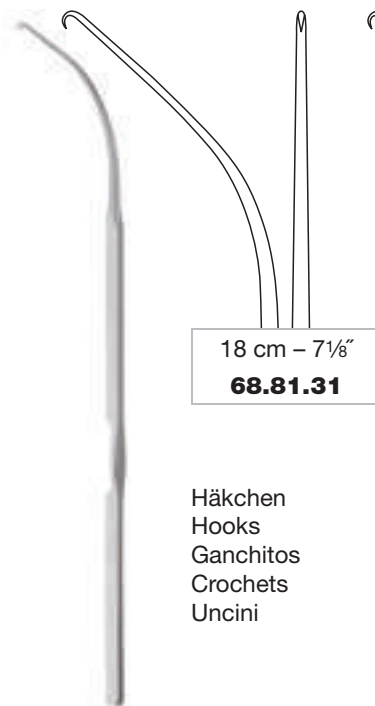

Blocksma

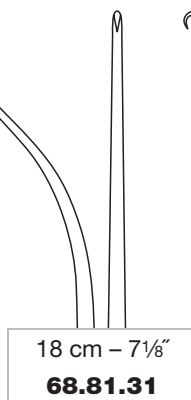

18 cm – 7 1/8"
68.81.31

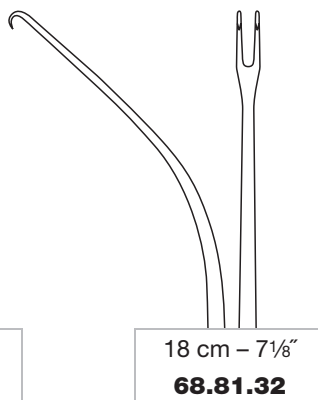

18 cm – 7 1/8"
68.81.32

Häkchen
 Hooks
 Ganchitos
 Crochets
 Uncini

Elevatorium
 Elevator
 Elevador
 Elévateur
 Elevatore

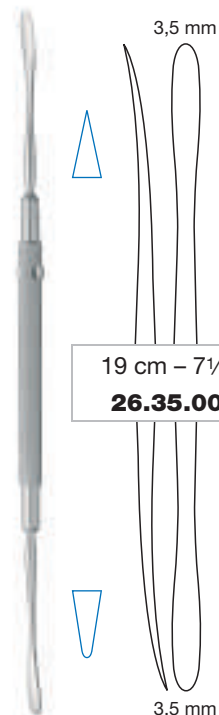

Freer-Scheer

19 cm – 7 1/2"
26.35.00

3,5 mm

Raspatorien
 Raspatories
 Legras
 Rugines
 Periostotomi

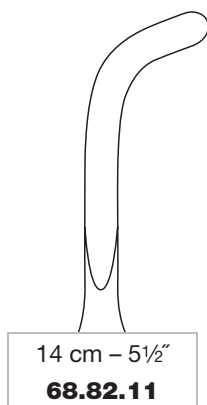

14 cm – 5 1/2"
68.82.11

Linke Seite
 Left side
 Lado izquierdo
 Côté gauche
 Lato sinistro

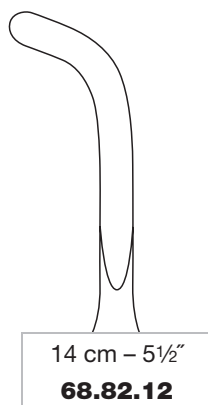

14 cm – 5 1/2"
68.82.12

Rechte Seite
 Right side
 Lado derecho
 Côté droite
 Lato destro

Raspatorium
 Raspatory
 Legra
 Rugine
 Periostotomo

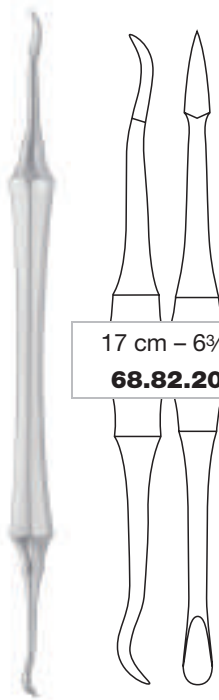

Kahre

17 cm – 6 3/4"
68.82.20



scharf
 sharp
 cortante
 tranchant
 tagliente



stumpf
 blunt
 roma
 mousse
 smussa



Raspatorien
 Raspatories
 Legras
 Rugines
 Periostotomi

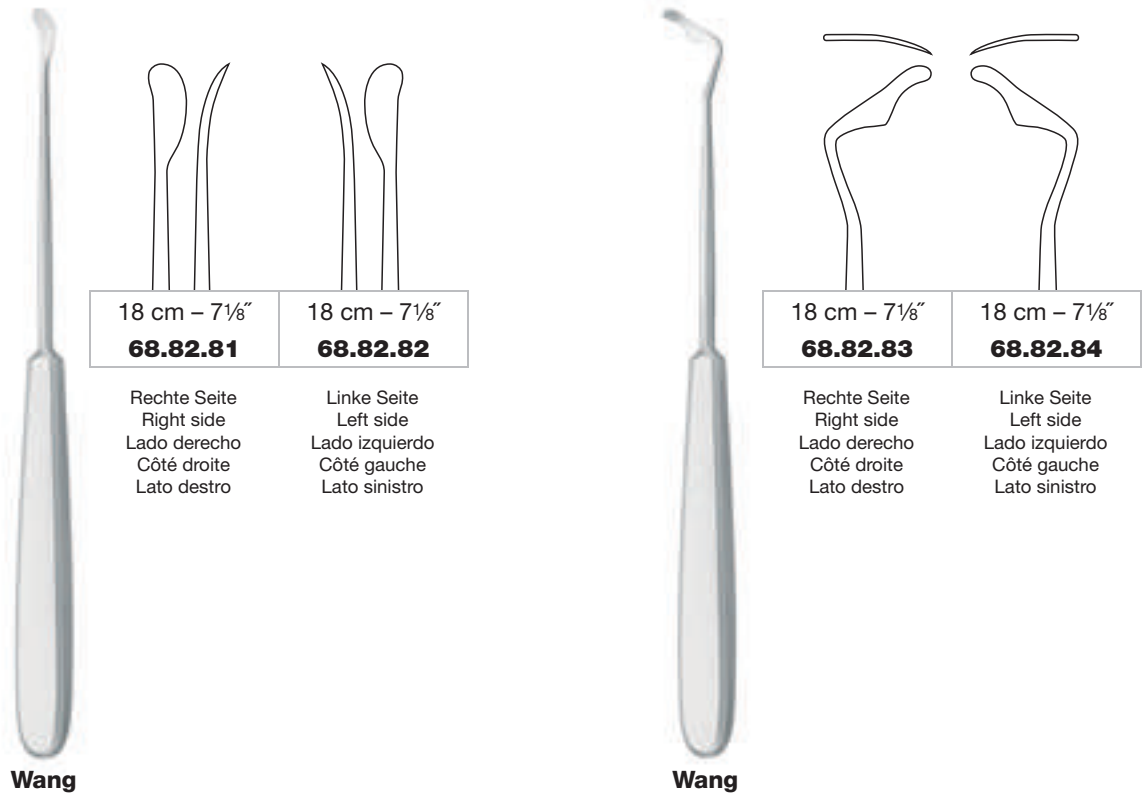
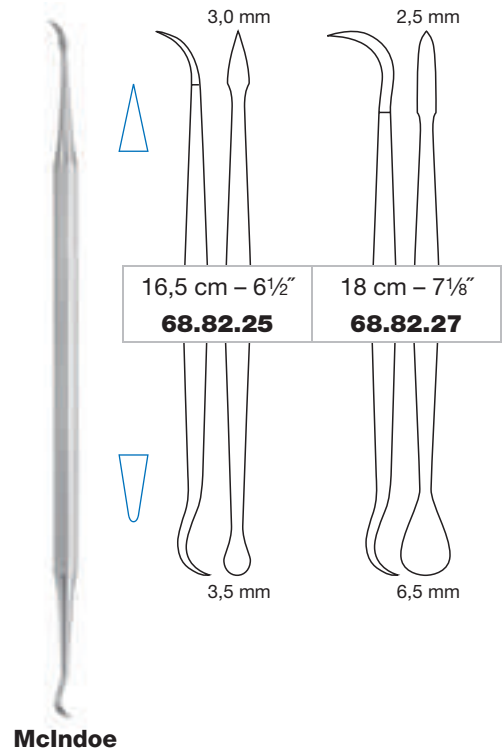

“KÖLN” MOUTH GAG

- ▶ Zahnhaken, gebogen
- ▶ Geringe Traumatisierung der Mundwinkel
- ▶ Verbesserte Sicht

- ▶ Tooth hooks, curved
- ▶ Less traumatization of corners of the mouth
- ▶ Improved visibility

- ▶ Ganchos dentales, curvados
- ▶ Poco traumatismo de la comisura bucal
- ▶ Visión mejorada

- ▶ Crochets dentales, courbé
- ▶ Traumatization des coins de bouche réduite
- ▶ Visibilité améliorée

- ▶ Uncini dentali, curvo
- ▶ Traumatizzazione ridotta degli angoli della bocca
- ▶ Vista migliorata

Mundsperrer
Mouth gag
Abreboca
Ouvre-bouche
Apribocca



Köln

45.52.30		
Satz bestehend aus: Set consisting of: Juego compuesto por: Jeu composé de: Set composto da:	Rahmen mit 2 Zahnhaken Frame with 2 tooth hooks Bastidor con 2 de ganchos dentales Cadre avec 2 de crochets dentaires Telaio con 2 di uncini dentali	1 x 45.52.31
	Zungendrücken Tongue depressors Bajalenguas Abaisse-langues Abbassalingua	1 x 45.57.11 1 x 72.08.11 1 x 72.08.12 1 x 72.08.13

Zungendrücken (siehe Seite 77)
Tongue depressors (see page 77)
Bajalenguas (véase página 77)
Abaisse-langues (voir page 77)
Abbassalingua (vedi pagina 77)



45.57.11 # 1



72.08.11 # 1

72.08.12 # 2

72.08.13 # 3

Rahmen mit 2 Zahnhaken (ohne Zungendrücken)
Frame with 2 tooth hooks (without tongue depressors)
Bastidor con 2 de ganchos dentales (sin bajalenguas)
Cadre avec 2 de crochets dentaires (sans abaisse-langues)
Telaio con 2 di uncini dentali (senza abbassalingua)



45.52.31



451.03.01

Unser komplettes Programm finden Sie in unserem Sonderprospekt.
For our complete line, see our special brochure.
El programa completo se encuentra en nuestro folleto especial.
Vous trouverez notre programme complet dans notre prospectus spécial.
Troverete il nostro programma completo nel nostro depliant speciale.



Sinuslifting-Elevatorien
Sinuslifting Elevators
Elevadores para sinus-lift
Élévateurs pour sinus-lift
Elevatori per sinus-lifting



3 mm

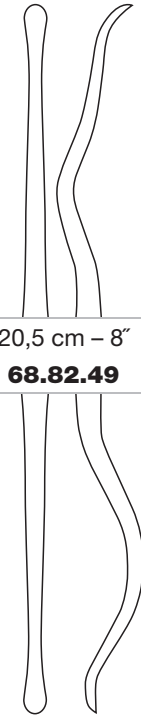

20,5 cm - 8"
68.82.49

3 mm

4 mm

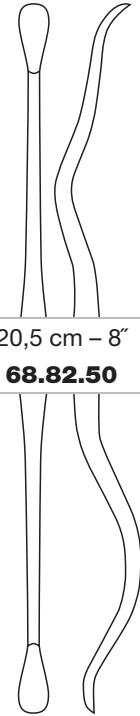

20,5 cm - 8"
68.82.50

4 mm

6 mm

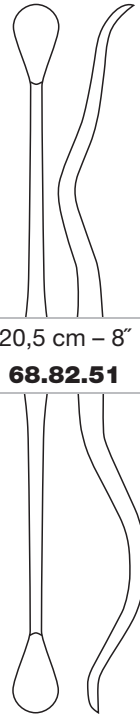

20,5 cm - 8"
68.82.51

6 mm



Stiller

3 mm

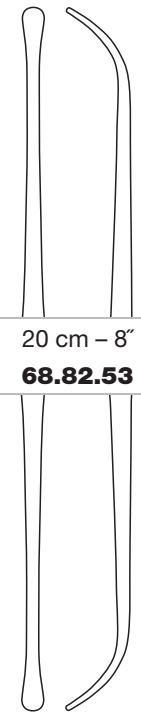

3 mm

4 mm

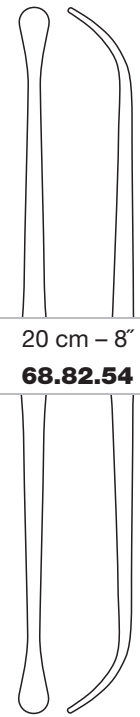

4 mm

6 mm

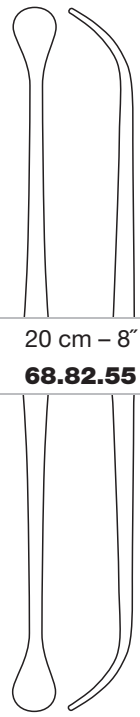

6 mm

20 cm - 8"
68.82.53

20 cm - 8"
68.82.54

20 cm - 8"
68.82.55

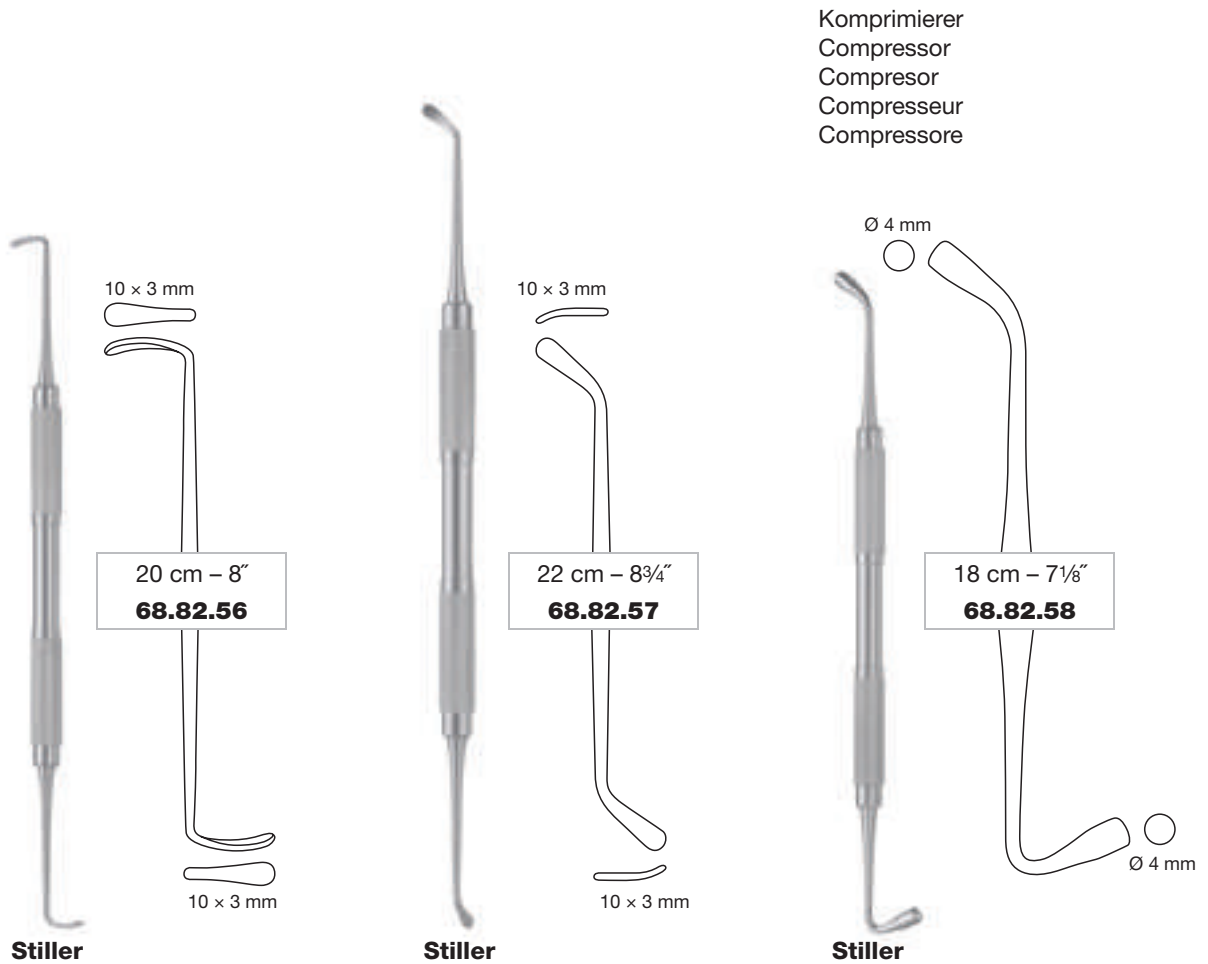

MEDICON

instruments

OMF SURGERY





SPECIALITIES



Spekulum zur Entfernung von Osteosynthesematerialien
Speculum for Removal of Osteosynthesis Materials
Espéculo para la remoción de implantes para la osteosíntesis
Spéculum pour l'enlèvement de matériel d'ostéosynthèse
Specolo per rimozione di mezzi di sintesi

Spekulum zur Entfernung von Osteosynthesematerialien
Speculum for removal of osteosynthesis materials
Espéculo para la remoción de implantes para la osteosíntesis
Spéculum pour l'enlèvement de matériel d'ostéosynthèse
Specolo per rimozione di mezzi di sintesi



- ▶ Einfache Entnahme von Osteosynthesematerialien
- ▶ Patientenschonend - in Lokalanästhesie möglich
- ▶ Gutes ästhetisches Resultat
- ▶ Easy removal of osteosynthesis materials
- ▶ Gentle on patients - local anaesthetics possible
- ▶ Well esthetic result
- ▶ Remoción fácil de implantes para la osteosíntesis
- ▶ Buen cuidado del paciente gracias a la realización de la cirugía en anestesia local
- ▶ Buen resultado estético
- ▶ Enlèvement facile de matériel d'ostéosynthèse
- ▶ Bénin pour le patient - anesthésie local possible
- ▶ Bon résultat esthétique
- ▶ Semplice asportazione di mezzi di sintesi
- ▶ Comfort per il paziente - possibile in anestesia locale
- ▶ Ottimo risultato estetico

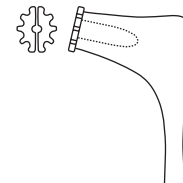

13,5 cm - 5 $\frac{3}{8}$ "
66.01.20

1:1



Kluba



“X-CHANGE” NASAL RASPS



Die sehr flachen Raspelblätter sind einzeln ersetzbar und gewährleisten auf effiziente Weise immer ein scharfes Instrument.

The very flat, individually replaceable rasp blades are an efficient way of always ensuring a sharp instrument.

Las hojas de la raspa muy planas pueden ser utilizadas por separado y garantizan de forma eficaz que uno dispone siempre de un instrumento adecuadamente afilado.

Les lames de râpes sont interchangeable et disponibles à l'unité. Ce qui assure de l'instrument un parfait tranchant.

Gli inserti di raspa molto fine sono sostituibili singolarmente e garantiscono in modo efficace uno strumento sempre tagliente.

Handgriffe
Handles
Mangos
Manches
Manici



14 cm – 5½"	15 cm – 6"
67.61.00	67.61.01

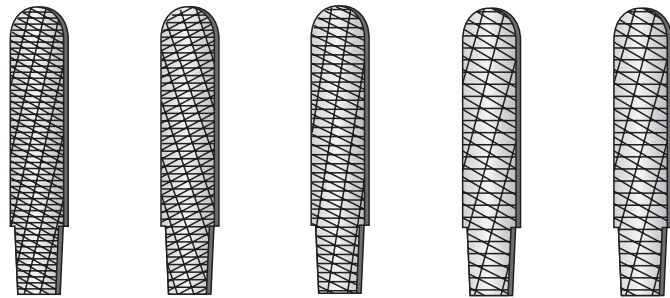

1:1

“HM”	# 1	# 2	# 3	# 4	# 5
	67.61.10	67.61.11	67.61.12	67.61.13	67.61.14

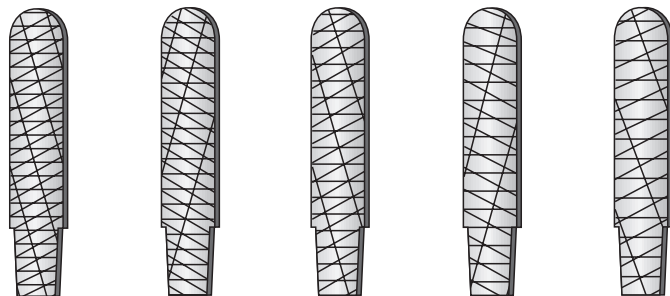

1:1

“HM”	# 6	# 7	# 8	# 9	# 10
	67.61.15	67.61.16	67.61.17	67.61.18	67.61.19



Schlüssel
Wrench
Llave
Clé
Chiave



67.61.03

“HM”

Hartmetall
Tungsten carbide
Carburo de tungsteno
Carbure de tungstène
Carburo di tungsteno



“CRISTACA” - SET

Beckenkamm-Hohlmeißel
 Iliac crest graft gouge
 Gubia para cresta ilíaca
 Gouge iliaque à transplant
 Sgorbia per cresta iliaca

mit Stopp
 with stop
 con stop
 avec stop
 con stop

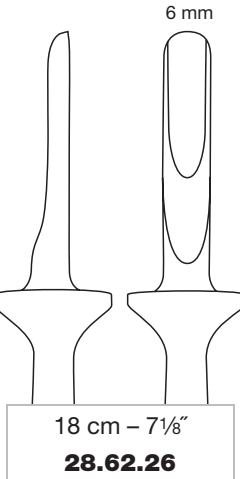
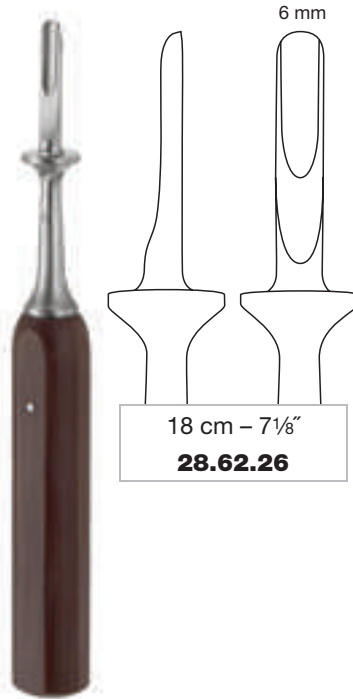

Beckenkamm-Löffel
 Iliac crest curette
 Cucharilla para la cresta ilíaca
 Curette pour la crête iliaque
 Cucchiaino per la cresta iliaca

mit Stopp
 with stop
 con stop
 avec stop
 con stop

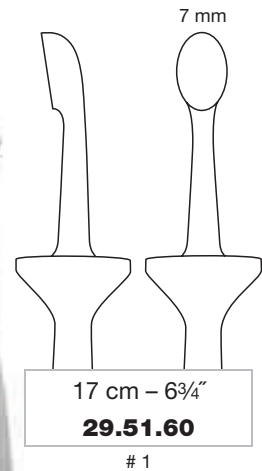
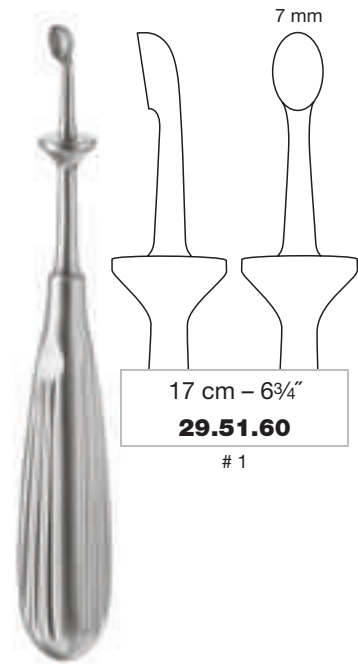

Trepane
 Trephines
 Trepanos
 Trépan
 Trapani

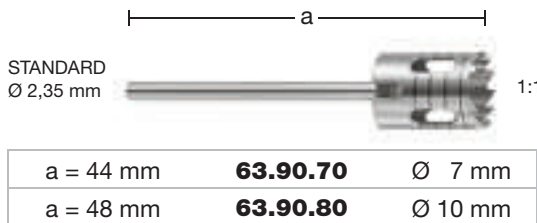

siehe Seite 130-131
 see page 130-131
 véase página 130-131
 voir page 130-131
 vedi pagina 130-131

SERVOTRONIC II



Bohrerstände (für 6 Bohrer bis 50 mm Länge)
 Burr rack (for 6 burs up to 50 mm length)
 Caballete para broca (para 6 brocas hasta 50 mm de long)
 Porte-forets (pour 6 forets d'une longueur 50 mm)
 Supporto perforatori (per 6 perforatori fino a 50 mm di lunghezza)



90 × 62 × 22 mm
46.35.22

Anmischbecher
 Mixing cup
 Vaso para mezclar
 Cupule à mélange
 Scodella p miscelare

mit Deckel
 with lid
 con tapa
 avec couvercle
 con coperchio



3 cm – 1 1/8" (50 ml)
47.50.60



Standard-Ansatz
 Standard shank end
 Talón estándar
 Embout standard
 Aggiunto standard



Beckenkamm-Retraktoren
 Iliac crest retractors
 Separadores para cresta iliaca
 Ecarteurs pour la crête iliaque
 Divaricatori per la cresta iliaca



Obwegeser

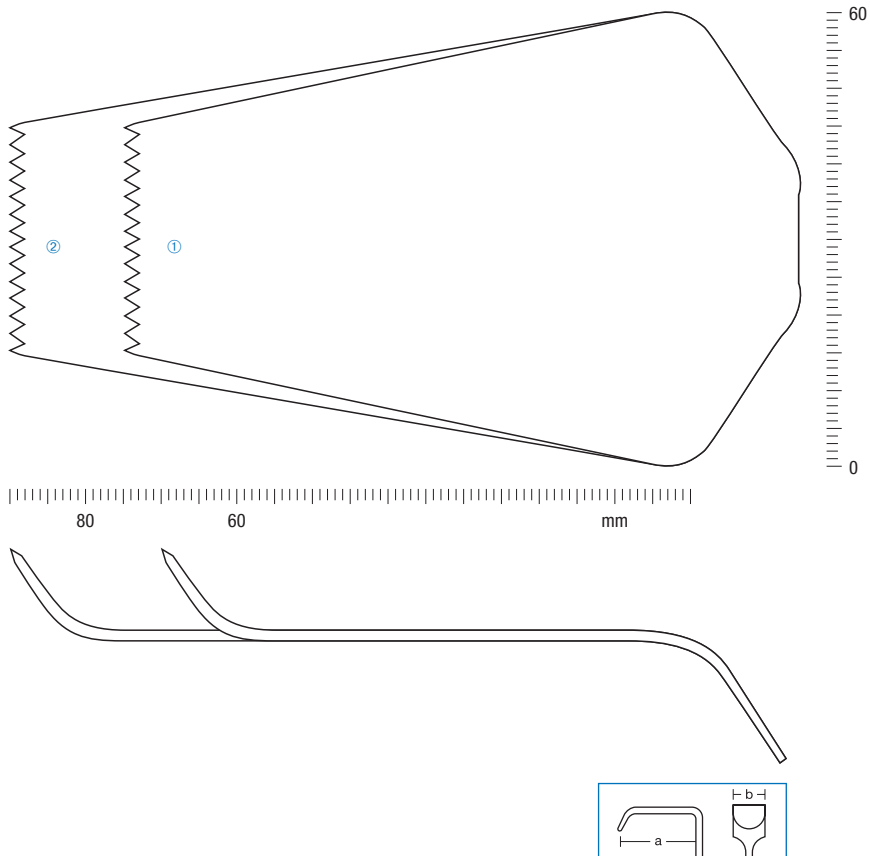

①	68.01.67	22 cm – 8 ³ / ₄ "	a = 60 mm	b = 30/60 mm
②	68.01.68	22 cm – 8 ³ / ₄ "	a = 80 mm	b = 30/60 mm



451.06.90

Unser komplettes "Cristaca"-Programm finden Sie in unserem Sonderprospekt.
 For our complete "Cristaca" line, see our special brochure.
 El programa completo "Cristaca" se encuentra en nuestro folleto especial.
 Vous trouverez notre programme complet "Cristaca" dans notre prospectus spécial.
 Troverete il nostro programma completo "Cristaca" nel nostro depliant speciale.



“SHEPARD” CYLINDER OSTEOTOMES

Kortikalisstanze
 Cortical cutter
 Punzonadora cortical
 Perforateur cortical
 Perforatore corticale



Shepard	12 cm – 4¾"	78.41.02	Ø 12 mm
----------------	-------------	-----------------	---------

Zylinder-Osteotome
 Cylinder osteotomes
 Osteotomos cilíndricos
 Ostéotomes cylindriques
 Osteotomi cilindrici



Shepard	12,5 cm – 5"	78.41.05	Ø 5 mm
	12,5 cm – 5"	78.41.06	Ø 6 mm
	12,5 cm – 5"	78.41.08	Ø 8 mm

Ausstoßer
 Rams
 Expulsores
 Pousoirs
 Espulsori



Shepard	14,0 cm – 5½"	78.41.12	Ø 5 mm
	14,0 cm – 5½"	78.41.13	Ø 6 mm
	14,0 cm – 5½"	78.41.14	Ø 8 mm

Trokare
 Trocars
 Trocares
 Trocart
 Trocar



Shepard	14,5 cm – 5¾"	78.41.15	Ø 5 mm
	14,5 cm – 5¾"	78.41.16	Ø 6 mm
	14,5 cm – 5¾"	78.41.18	Ø 8 mm

Querstift
 Cross pin
 Espiga transversal
 Embout transversal
 Perno trasversale

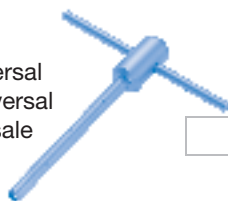

Shepard	11 cm – 4¾"	78.41.11	Ø 6 mm
----------------	-------------	-----------------	--------

zum Drehen der Zylinder-Osteotome
 for turning cylinder osteotomes
 para girar osteotomos cilíndricos
 pour la rotation de l'ostéotome cylindrique
 per la rotazione degli osteotomi cilindrici

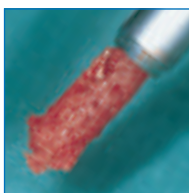

Knochenmühle
 Bone mill
 Molino de hueso
 Moulin à os
 Mulino per ossa

mit Montageschlüssel
 with assembling wrench
 con llave de montaje
 avec clé de montage
 con chiave per montaggio



Ø 68 mm
 11 cm – 4³/₈"
68.82.75

Ermöglicht ein Zerkleinern von Knochenstücken
 Enables crushing of compact bone pieces
 Permite moler fragmentos óseos
 Pour broyage des fragments d'os
 Rende possibile tritare frammenti ossei

Knochenmühle
 Bone mill
 Molino de hueso
 Moulin à os
 Mulino per ossa

mit Titan-Mahlwerk
 with titanium grinder
 con trituradora de titanio
 avec broyeur en titane
 con fresa in titanio



Stellschraube für die Festlegung der Partikelgröße
 Locking screw to determine size of bone particles
 Tornillo de ajuste para la determinación del tamaño de las partículas
 Vis de réglage pour définir la taille des particules
 Vite di regolazione per definire la dimensione delle particelle

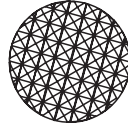

Ø 16 mm

 16,5 cm – 6¹/₂"
68.82.76

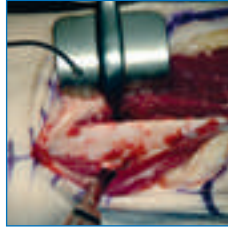

Fibula-Raspatorium
Fibula Raspatory
Legra para fibula
Fibula rugine
Fibula periostotomo

Fibula-Raspatorium
 Fibula raspatory
 Legra para fibula
 Fibula rugine
 Fibula periostotomo



Mit dem gebogenen und als Kontrawinkel angepassten Ende des Raspatoriums kann die Fibula proximal und distal schonend umfahren werden.
 Die Abhalte-Vorrichtung funktioniert als Wundhaken zur Verdrängung des Musculus peroneus, der die Osteotomie-Stelle bedeckt.

The proximal and distal fibula can be gently circumnavigated thanks to a raspatory the end of which has been curved and adjusted to make a counter-angle.
 The holding device works as a retractor to push back the peroneus longus that covers the osteotomy site.

Con el extremo curvo y adaptado como contraángulo de la legra se puede rodear el peroné proximal y distal sin dañarlo.
 El dispositivo de separación funciona como separador para desplazar el músculo peroneal que cubre el lugar de la osteotomía.

L'extrémité courbée de la rugine, prenant la forme d'un contre-angle, permet de contourner la fibula de manière proximale et distale, sans l'abîmer.
 Le dispositif de serrage fonctionne comme un écarteur pour repousser le muscle fibulaire recouvrant la zone de l'ostéotomie.

Con l'estremità del periostotomo, ricurvo e adeguato come contrangolo, il perone può essere sottoposto a delicata dissezione prossimale e distale.
 La valva funziona da retrattore per il muscolo peroneo che copre il campo dell'osteotomia.



Hakim

1:1.25

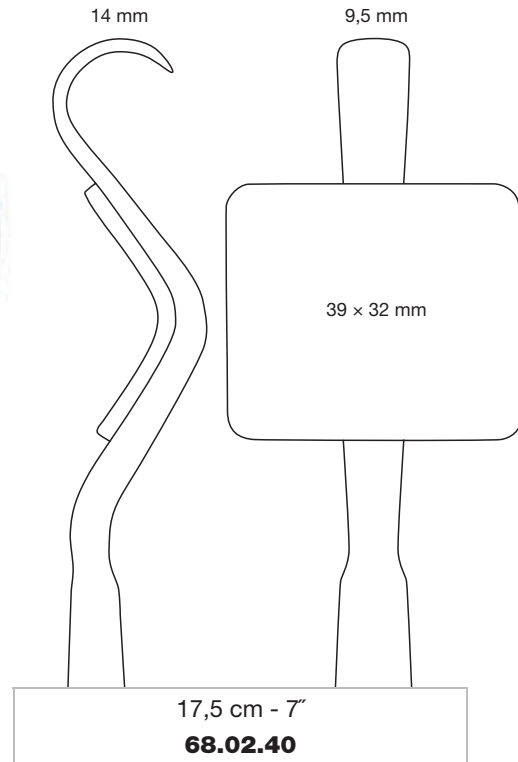

17,5 cm - 7"
68.02.40



Mucotom mit Intra-Kupplung
 Mucotome with intra-coupling
 Mucotomo con intra-acoplamiento
 Mucotome avec intra-accouplement
 Mucotomo con accoppiamento intra

0,2 - 1,2 mm
 Schnittstärke
 Thickness of cut
 Grosor del corte
 Epaisseur de la coupe
 Spessore del taglio

22 mm (max)
 Schnittbreite
 Width of cut
 Ancho del corte
 Largeur de la coupe
 Larghezza del taglio

Klinge
 Blade
 Hoja
 Lame
 Lama



Steinhäuser

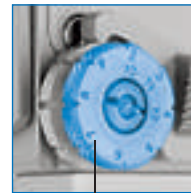

je Stufe (2-12) = 0,1 mm
 per step (2-12) = 0.1 mm
 por grado (2-12) = 0,1 mm
 chacune degré (2-12) = 0,1 mm
 per grado (2-12) = 0,1 mm

5.000 U/min

14 cm - 5½"

68.25.03

ohne Klinge
 without blade
 sin hoja
 sans lame
 senza lama

Klingenhaltepinzette mit Schraubendreher
 Blade holding forceps with screwdriver
 Pinza porta-hoja con destornillador
 Pince porte-lame avec tournevis
 Pinza portalama con cacciavite



11 cm - 4¾" **68.25.17**

Mucosa-Spanner
 Mucosa stretcher
 Tensor de mucosa
 Tendeur de muqueuse
 Tenditore di mucosa

mit Schleimhauthaken
 with mucosa retractor
 con separador de mucosa
 avec crochet pour muqueuse
 con divaricatore per mucosa

68.25.21

Schleimhauthaken (allein)
 Mucosa retractor (only)
 Separador de mucosa (solo)
 Crochet pour muqueuse (seul)
 Divaricatore per mucosa (solo)



Steinhäuser

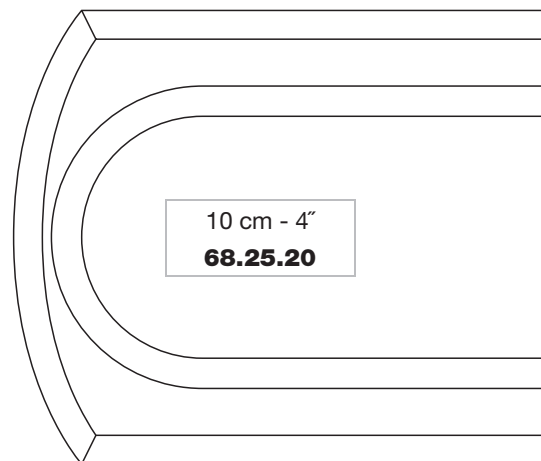

10 cm - 4"
68.25.20



Maximale Motordrehzahl
 Maximum speed
 Revoluciones máximas del motor
 Nombre de tours maximum
 Massimo numero di giri del motore



Verpackungseinheit "X" Stück
 Packing unit "X" pieces
 Paquete de "X" unidades
 Emballage de "X" pièces
 Confezione da "X" pezzi



SERVOTRONIC II EC100

Steuergerät mit Touchscreen-Bedienelement und Spülpumpe
 Control unit with touchscreen operating element and irrigation pump
 Unidad de control con touch screen y bomba de irrigación
 Unité centrale réglage au moyen d'un écran tactile et pompe d'irrigation
 Unità di controllo con touch-screen e pompa d'irrigazione

Spannung Voltage Voltaje Tensione Tensione	Pumpenleistung Pumpage Rendimiento de la bomba Puissance de la pompe Potenza della pompa	Gewicht netto Net weight Peso neto Poids net Peso netto	Drehzahl Revolution per minute Número de revoluciones Nombre de tours Numero di giri
100-240 V (50-60 Hz)	120 ml/min	10,1 kg	45.000 U/min (max.)



Servotronic II EC100

92.11.10

36 × 36 × 14 cm

Satz komplett bestehend aus:
 Set complete consisting of:
 Juego completo compuesto por:
 Jeu complet composé de:
 Set completo composto da:

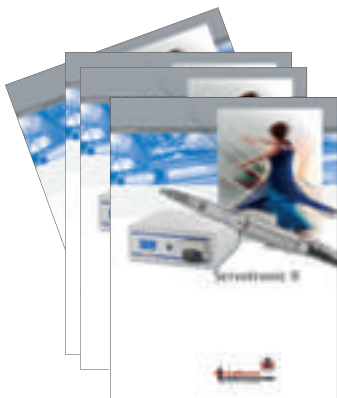

		
Steuergerät Control unit Unidad de control Unité centrale Unità di comando	Mikromotor Micro motor Micromotor Micromoteur Micromotore	Fußpedal Foot pedal Interruptor a pedal Interrupteur à pédale Interruttore a pedale
92.11.20	92.11.27	92.20.25

451.03.31

Unser komplettes SERVOTRONIC-Programm finden Sie in unserem Sonderprospekt.
 For our complete SERVOTRONIC program please ask for our special brochure.
 Nuestro programa completo de SERVOTRONIC se encuentra en nuestro folleto especial.
 Vous trouverez notre programme complet des SERVOTRONIC dans notre prospectus spécial.
 Il nostro programma completo di SERVOTRONIC lo troverete nel depliant speciale.

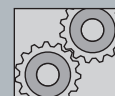

Beim Einsatz mit dem "Servotronic II EC100"-System sind bauartbedingt maximal 45.000 U/min erreichbar. Alle Handstücke passend für Werkzeuge mit Schaft-Ø 2,35 mm.

When using the "Servotronic II EC100" system maximal 45.000 rpm can be reached. All hand pieces suitable for tools with shaft diameter 2,35 mm.

Dévido a la construcción del sistema "Servotronic II EC100" se alcanza como máximo 45.000 rev./min. Todas las piezas de mano son concebidas para la utilización con terminales con un diametro del vástago de 2,35 mm.

L'utilisation du système "Servotronic II EC100" permet d'atteindre une puissance de 45.000 t/min. Toutes les pièces à main sont adaptées aux outils de diamètre 2,35 mm.

Data la struttura, con l'utilizzo del sistema "Servotronic II EC100" si possono raggiungere al massimo 45.000 giri/min. Tutti i manipoli sono adatti per punte del diametro di 2,35 mm.

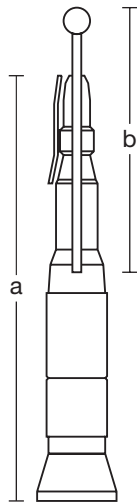

Chirurgische Handstücke
Surgical hand pieces
Piezas de mano quirúrgicas
Pièces à main chirurgicales
Manipoli chirurgici



mit Drehring-Spannzange und Spülrohr
with swivel chuck and irrigation tube
con cierre de anillo y tubo de irrigación
avec serrage à rotation et canule de lavage
con chiusura ad anello girevole e tubo di lavaggio



mit Farbmarkierung für Übersetzungsverhältnis
with colour coding for gear transmission ratio
con relación de transmisión identificada por colores
avec marquage de couleur indiquant le rapport de transmission
con codice colore per rapporto di trasmissione

STRYKER/STANDARD



a = 85 mm b = 45 mm **63.45.07** 1:1

STRYKER/STANDARD



a = 111 mm	b = 44 - 70 mm	63.45.11	1:1
a = 131 mm	b = 70 - 95 mm	63.45.13	1:1
a = 161 mm	b = 95-125 mm	63.45.15	1:1

STANDARD
Ø 2,35 mm

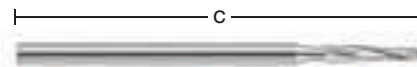

Lindemann

Fräser
Burs
Fresas
Fraises
Frese

# 1	c = 75 mm	68.61.01
# 2	c = 65 mm	68.61.02
# 3	c = 45 mm	68.61.03



Stryker-Ansatz
Stryker shank end
Stryker talón
Stryker embout
Stryker attacco



Standard-Ansatz
Standard shank end
Talón estándar
Embout standard
Attacco standard



Winkelschraubendreher
Angular Screwdrivers
Destornilladores de ángulo
Tournevis angulaire
Cacciaviti angolati

Winkelschraubendreher
Angular screwdrivers
Destornilladores de ángulo
Tournevis angulaire
Cacciaviti angolati

für Handantrieb oder Mikromotor
 for hand drive or micro motor
 para uso manual o con micromotor
 avec commande manuelle ou micromoteur
 per l'utilizzo manuale o con il micromotore



13:1	19 cm - 7½"	68.30.01
6,5:1	19 cm - 7½"	68.30.10

Winkelschraubendreher für Plattenosteosynthesen in schwer zugänglichen Regionen des Unterkiefers und Mittelgesichtes anstelle einer transbukkalen/transfacialen Weichteilperforation direkt über den intraoralen, supra-/infraorbitalen oder coronalen Zugang zur Fraktur.

Angular screwdriver for plate osteosynthesis in not easily accessible regions of the mandible and mid-face instead of a transbuccal/transfacial softtissue perforation directly through the intraoral supra-/infraorbital or coronal approach to a fracture.

Destornillador de ángulo para osteosíntesis de placas en regiones difíciles de la mandíbula y del tercio medio, en vez de una perforación de las partes blandas transbukcales y transfaciales directamente encima del acceso infraorbital o coronal a la fractura.

Tournevis angulaire pour des ostéosyntheses à plaques dans des régions d'un abord difficile au niveau de la mâchoire inférieure et du milieu du visage, au lieu d'une perforation transbukcale/transfaciale des parties molles directement sur l'accès intraoral, supra-/infraorbital ou coronal de la fracture.

Cacciavite angolato per placche di osteosintesi in zone di difficile accesso della regione mascellare e mediofaciale, in sostituzione della perforazione transbukcale e transfaciale di parti molli, accedendo alla frattura direttamente in modo intraorale, orbitale o coronale.

Schraubenhaltevorrichtung für Winkelschraubendreher
 Screw holding device for angular screwdriver
 Dispositivo para tornillos para destornillador de ángulo
 Dispositif de vis pour tournevis angulaire
 Dispositivo portaviti per cacciavite angolato



15,5 cm - 6¼"	68.30.06
---------------	-----------------

bestehend aus: consisting of: compuesto por: composé de: composto da:	68.30.07	Klemmbacken Fixation clamps Mordazas Clips pour le dispositif de vis Clip di fissazione	2x
	68.30.08	Haltefeder Retaining spring Resorte para dispositivo Ressort pour le dispositif de vis Molla per dispositivo	1x
		Schraubendreher zur Montage Screwdriver for mounting purposes Destornillador para el ensamblaje Tournevis pour le montage Giravite per montaggio	1x

Handantrieb für Winkelschraubendreher
Manual drive for angular screwdriver
Impulso manual para destornillador de ángulo
Manivelle pour tournevis angulaire
Manico d'azionamento per cacciavite angolato

mit rotierendem Endstück
 with freely roating end piece
 con pieza final giratoria
 avec bout rotatif indépendant
 con pezzo finale a rotazione libera



12 cm - 4¾"	68.30.05
-------------	-----------------

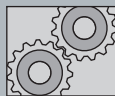

Schraub-Einsätze
Screwing inserts
Insertos para destornillador
Embouts pour le tournevis
Inserti per cacciavite

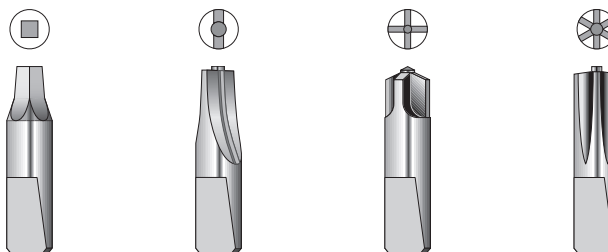

2:1

1.5 MICRO

68.30.38	68.30.36	68.30.51	68.30.50
		● 68.30.43	● 68.30.41

2.0 MINI

68.30.37	68.30.34	68.30.53	68.30.52
		● 68.30.47	● 68.30.44

2.4 MANDIBULAR

		68.30.49	68.30.48
--	--	-----------------	-----------------

für Kondylen
for condylar implants
para condilos
pour condyles
per condili



2:1

68.30.39



Vorbohrer-Einsätze
Drill inserts
Insertos para brocas
Embouts perforateurs
Perforatori per cacciavite angolati

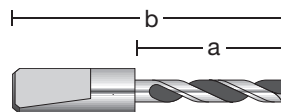

2:1

1.5	a = 6 mm	b = 14 mm	68.30.19	Ø 1,2 mm
2.0	a = 6 mm	b = 14 mm	68.30.20	Ø 1,5 mm
2.0	a = 18 mm	b = 21 mm	68.30.18	Ø 1,6 mm
2.4	a = 6 mm	b = 10 mm	68.30.21	Ø 1,7 mm

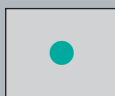

Für die Aufnahme aus Schraubenmagazinen mit versenkten Schrauben nicht geeignet
Not suitable to take out countersunk screws of the storing tray
No apto para el agarre de racks de tornillos avellanados
Ne pas approprié à prendre des vis enfoncées de la cartouche
Non è appropriato per la presa delle viti incassate dalle cartucce



Oszillierende Mikro-Säge mit Gabelschlüssel
 Micro oscillating saw with fork wrench
 Micro sierra oscilante con llave horquilla
 Micro scie oscillante avec clef
 Micro sega oscillante con chiave a forcina

Integriertes Spülrohr
 Integrated irrigation tube
 Tubo de irrigación integrado
 Canule de lavage intégrée
 Tubo di lavaggio integrato

68.24.20

Gabelschlüssel (allein)
 Fork wrench (only)
 Llave horquilla (sola)
 Clef (seule)
 Chiave a forcina (sola)



Sachse

68.24.19

Ersatz-Überwurfmutter für Spannfutter
 Spare fixation nut for chuck
 Tuerca de racor de repuesto para mandril de sujeción
 Ecrou fileté pour mandrin de serrage
 Dado per raccordi di ricambio per mandrino

15.000 U/min

12,5 cm - 5"
68.24.00

ohne Sägeblätter
 without saw blades
 sin hojas de sierra
 sans lames de scie
 senza lame da sega

Sägeblätter
 Saw blades
 Hojas de sierra
 Lames de scie
 Lame da sega

Nutzlänge
 Working length
 Largo útil
 Longueur utile
 Lunghezza utile

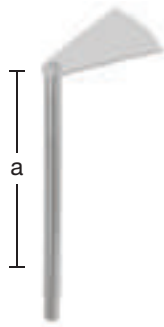

6 mm	10 mm	15 mm	6 mm	1:1
0,3 mm	0,3 mm	0,3 mm	0,15 mm	
a = 11 mm	a = 11 mm	a = 11 mm	a = 11 mm	
68.24.24	68.24.25	68.24.26	68.24.30	
6 mm	10 mm	15 mm	6 mm	1:1
0,3 mm	0,3 mm	0,3 mm	0,15 mm	
a = 26 mm	a = 26 mm	a = 26 mm	a = 26 mm	
68.24.27	68.24.28	68.24.29	68.24.31	



Mikro-Sagittal-Säge mit Gabelschlüssel
 Micro sagittal saw with fork wrench
 Micro sierra sagital con llave horquilla
 Micro scie sagittale avec clef
 Micro sega sagittale con chiave a forcina

Integriertes Spülrohr
 Integrated irrigation tube
 Tubo de irrigación integrado
 Canule de lavage intégrée
 Tubo di lavaggio integrato

68.24.20

Gabelschlüssel (allein)
 Fork wrench (only)
 Llave horquilla (sola)
 Clef (seule)
 Chiave a forcina (sola)



Sachse

68.24.19

Ersatz-Überwurfmutter für Spannfutter
 Spare fixation nut for chuck
 Tuerca de racor de repuesto para mandril de sujeción
 Ecrou fileté pour mandrin de serrage
 Dado per raccordi di ricambio per mandrino

 20.000 U/min

12,5 cm - 5"

68.24.02

ohne Sägeblätter
 without saw blades
 sin hojas de sierra
 sans lames de scie
 senza lame da sega

Sägeblätter
 Saw blades
 Hojas de sierra
 Lames de scie
 Lame da sega

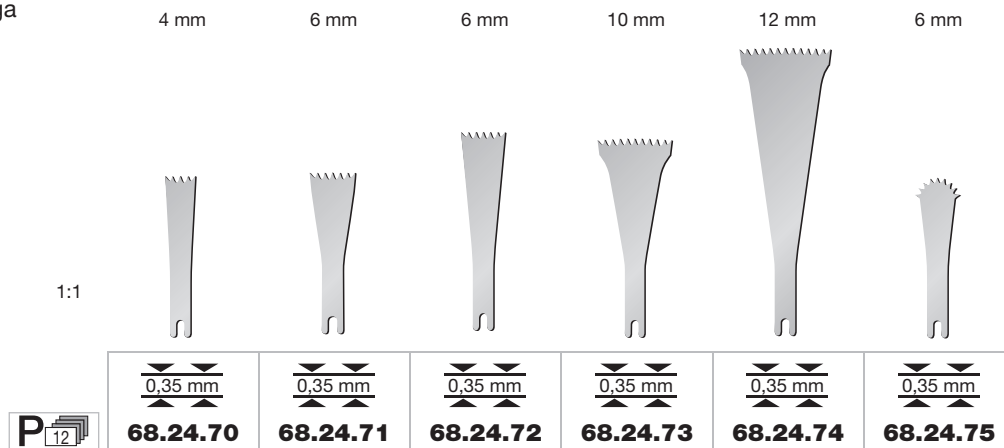



Osseoskalpell mit Gabelschlüssel
 Osseoscalpel with fork wrench
 Osseoscalpel con llave horquilla
 Osséoscalpel avec clef
 Osseoscalpello con chiave a forcina

Integriertes Spülrohr
 Integrated irrigation tube
 Tubo de irrigación integrado
 Canule de lavage intégrée
 Tubo di lavaggio integrato

68.24.20

Gabelschlüssel (allein)
 Fork wrench (only)
 Llave horquilla (sola)
 Clef (seule)
 Chiave a forcina (sola)



Sachse

68.24.19

Ersatz-Überwurfmutter für Spannfutter
 Spare fixation nut for chuck
 Tuerca de racor de repuesto para mandril de sujeción
 Ecrou fileté pour mandrin de serrage
 Dado per raccordi di ricambio per mandrino

20.000 U/min

12,5 cm - 5"
68.24.05

US Pat. 5.201.749o
 DE 40 29 676

ohne Sägeblätter
 without saw blades
 sin hojas de sierra
 sans lames de scie
 senza lame da sega



Mikro-Säge mit axial/sagittalem Schnitt, Pendelhub, besonders geeignet für dreidimensionale Schnitfführungen
 Micro saw with axial/sagittal cut, oscillating hub, especially suitable for three dimensional cutting
 Micro sierra con corte axial/sagital, elevacion de pendulo, especialmente apropiada para cortes tridimensionales
 Micro scie à coupe axiale/sagittale, par voie excentrique, particulièrement conçue pour des coupes tridimensionnelles
 Micro sega con taglio assiale/saggitale, corsa del pendolo, adatto specialmente per guida tagli tredimensionali

Sägeblätter
 Saw blades
 Hojas de sierra
 Lames de scie
 Lame da sega

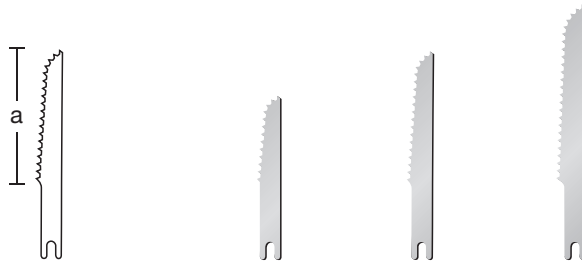

1:1

P

$\frac{0,35 \text{ mm}}{0,35 \text{ mm}}$	$\frac{0,35 \text{ mm}}{0,35 \text{ mm}}$	$\frac{0,35 \text{ mm}}{0,35 \text{ mm}}$
a = 12 mm	a = 18 mm	a = 24 mm
68.24.35	68.24.36	68.24.37



Mikro-Stichsäge mit Gabelschlüssel
Micro compass saw with fork wrench
Micro sierra de vaivén con llave horquilla
Micro scie à guichet avec clef
Micro sega con chiave a forcina

Abnehmbares Spülrohr
Detachable irrigation tube
Tubo de irrigación desmontable
Canule de lavage démontable
Tubo di lavaggio smontabile

68.24.22

Ersatz-Spülrohr
Spare irrigation tube
Tubo para irrigación de recambio
Canule de lavage de rechange
Tubo di lavaggio di ricambio

68.24.20

Gabelschlüssel (allein)
Fork wrench (only)
Llave horquilla (sola)
Clef (seule)
Chiave a forcina (sola)



68.24.19

Ersatz-Überwurfmutter für Spannfutter
Spare fixation nut for chuck
Tuerca de racor de repuesto para mandril de sujeción
Ecrou fileté pour mandrin de serrage
Dado per raccordi di ricambio per mandrino

20.000 U/min

12,5 cm - 5"

68.24.10

ohne Sägeblätter
without saw blades
sin hojas de sierra
sans lames de scie
senza lame da sega

Hartmetall-Raspelaufsatz
Tungsten carbide rasp
Escofina de carburo de tungsteno
Râpe en carbure de tungstène
Raspa in carburo di tungsteno



"HM"

68.24.21

5,5 cm - 2 1/8"

Sägeblätter
Saw blades
Hojas de sierra
Lames de scie
Lame da sega

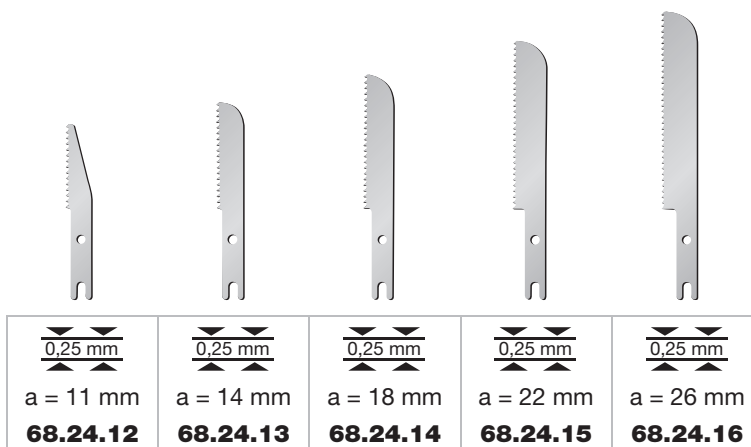
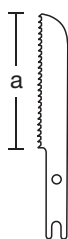

P₁₂

1:1

"HM"

Hartmetall
Tungsten carbide
Carburo de tungsteno
Carbure de tungstène
Carburo di tungsteno

P_X

Verpackungseinheit "X" Stück
Packing unit "X" pieces
Paquete de "X" unidades
Emballage de "X" pièces
Confezione da "X" pezzi



Indikationsbereiche
 Fields of applications
 Campos de indicación
 Secteurs d'application
 Campi di applicazione



		68.24.00	68.24.02	68.24.05	68.24.10
Craniofaziale Chirurgie Craniofacial Surgery Cirugía craneofacial Chirurgie crano-faciale Chirurgia craniofacciale	Entnahme von Kalotten-Transplantaten Harvesting of cranial bone grafts Extracción de trasplantes de calota Prélèvement de transplants de la calotte Prelievo di innesti della calotta	○	☆	★	☆
	Osteotomie des Frontal Bandeau einschließlich Orbitotomie Osteotomy of the frontal bandeau including orbitotomy Osteotomía de la banda frontal incluido orbitotomía Ostéotomie du bandeau frontal avec orbitotomie Osteotomia della fascia frontale incluso orbitotomia	○	☆	★	☆
	Osteotomie und Konturierung der Kalottensegmente Osteotomy and contouring of cranial segments Osteotomía y contorneado de los segmentos de la calota Ostéotomie et contours des segments de la calotte Osteotomia e contornitura dei segmenti di calotta	☆	★	☆	○
	Osteotomie im Nasoethmoidalkomplex Osteotomy within the nasal ethmoidal complex Osteotomía en el complejo nasoetmoidal Ostéotomie dans le complexe nasoéthmoïdal Osteotomia nel complesso nasoetmoidale	—	☆	☆	☆

		68.24.00	68.24.02	68.24.05	68.24.10
Maxillofaziale Chirurgie Maxillofacial Surgery Cirugía maxilofacial Chirurgie maxillo-faciale Chirurgia maxillofacciale	Interdentale Osteotomie Interdental osteotomy Osteotomía interdental Ostéotomie interdendale Osteotomia interdendale	☆	☆	☆	☆
	Transverse Orbitotomie Transversal orbitotomy Orbitotomía transversal Orbitotomie transversale Orbitotomia trasversale	★	○	○	○
	Osteotomie der fazialen Unterkieferwand nach Abello oder Lindorf Osteotomy of the facial mandibular wall acc. to Abello or Lindorf Osteotomía de la pared mandibular facial según Abello o Lindorf Ostéotomie de la paroi du maxillaire inférieure faciale selon Abello ou Lindorf Osteotomia della parete mandibolare facciale secondo Abello o Lindorf	★	☆	☆	☆
	Vertikale Osteotomie des aufsteigenden Unterkiefers von intraoral Vertical osteotomies of the ascending ramus from intraoral Osteotomías verticales del maxilar inferior ascendente desde intraoral Ostéotomies verticales du maxillaire inférieur montant, en intra-oral Osteotomie verticali della mandibola ascendente intraorali	★	—	—	—
	Laterale Segmentosteotomien Lateral segment osteotomies Osteotomías de segmentos laterales Ostéotomies des segments latéraux Osteotomie di segmenti laterali	★	☆	☆	☆
	Anteriore Segmentosteotomien Anterior segment osteotomies Osteotomías de segmentos anteriores Ostéotomies des segments antérieurs Osteotomie di segmenti anteriori	☆	☆	★	★



sehr gut geeignet
 absolutely suitable
 especialmente apto
 très approprié
 perfettamente appropriate



gut geeignet
 very suitable
 muy apto
 bien approprié
 molto appropriato

Indikationsbereiche
Fields of applications
Campos de indicación
Secteurs d'application
Campi di applicazione



		68.24.00	68.24.02	68.24.05	68.24.10
Maxillofaziale Chirurgie Maxillofacial Surgery Cirugía maxilofacial Chirurgie maxillo-faciale Chirurgia maxillofacciale	Osteotomie der Le Fort Ebenen Le Fort osteotomies Osteotomías de los planos de Le Fort Ostéotomies des plans de Le Fort Osteotomie dei piani di Le Fort	—	☆	☆	☆
	Osteotomie des Unterkiefers inklusive sagittale Spaltung Mandibular osteotomies incl. sagittal split Osteotomías del maxilar inferior inclusive escisión sagital Ostéotomies du maxillaire inférieur avec fission sagitale Osteotomie della mandibola compreso l'osteotomia saggitale	—	○	★	○
	Kinnosteotomie Chin osteotomies Osteotomías de mentón Ostéotomies du menton Osteotomie del mento	○	○	★	☆
	Tumorresektionstherapie Tumor resection therapy Terapia de resección de tumores Thérapie par résection tumorale Terapia di resezione dei tumori	○	☆	★	☆
	Osteotomie der Scapula, des Beckenkammes und der Fibula im Rahmen der Rekonstruktionstherapie Osteotomy of scapula, iliac crest and fibula within reconstruction therapy Osteotomía de los omóplatos de la cresta iliaca del peroné en el marco de la terapia reconstructiva Ostéotomie de l'omoplate, du bassin et du péroné, dans le cadre de la thérapie reconstructive Osteotomia della scapola, della cresta iliaca e del perone nell'ambito della terapia ricostruttiva	○	☆	☆	☆

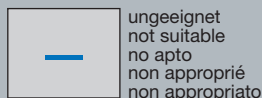



Weitere Produkte für die Mund-Kiefer-Gesichtschirurgie
Further Products for Maxillofacial Surgery
Más productos para la cirugía maxilofacial
D'autres produits pour la chirurgie maxillo-faciale
Altri prodotti per la chirurgia maxillo-facciale



451.09.01

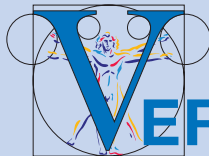
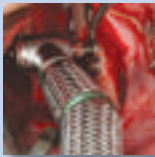

VERONA WAY OF DOING IT



entwickelt in Zusammenarbeit mit:
developed in cooperation with:
desarrollado en cooperación con:
réalisé en collaboration avec:
realizzato in collaborazione con:

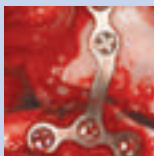

Bimaxillary Surgery

OP-Technik und Instrumentarium
Surgical technique and instrumentation
Técnica quirúrgica e instrumentos
Technique opératoire et instruments
Tecnica operatoria e strumentario

Dieser Prospekt zeigt Schritt für Schritt eine bimaxilläre Operation mit dem in Folge verwendeten Instrumentarium.

This brochure shows "step by step" a bimaxillary surgery as well as the sequence of instruments used.

En el folleto actual presentamos paso por paso una cirugía bimaxilar junto con los instrumentos que se usan en secuencia.

Cette brochure montre pas à pas une opération bimaxillaire et les instruments employés dans l'ordre d'utilisation.

Questo depliant fa vedere passo per passo un'intervento bimascellare e lo strumentario usato.

Prof. Dr. Pier Francesco Nocini
Dr. Massimo Albanese
Prof. Dario Bertossi
Dr.ssa Nadia Toller

University of Verona
Dept. of Dentistry and Maxillo-Facial Surgery
Pol. G.B. Rossi
Piazzale L.A. Scuro 10 - 37134 Verona - Italy
E-Mail: massimo.albanese@univr.it



451.08.12

Distraction Devices

Enorale Distraktoren für die Ober- und Unterkiefer
 Intraoral distraction devices for upper and lower jaw
 Distractores intraorales para la mandíbula inferior y superior
 Distracteurs intra-oraux pour mâchoire inférieure et supérieure
 Distrattori intraorali per il mascellare inferiore e superiore



Horizontale Unterkieferdistraktoren
 Horizontal mandibular distraction devices
 Distractores horizontales para la mandíbula inferior
 Distracteurs mandibulaires horizontals
 Distrattori mandibolari orizzontali

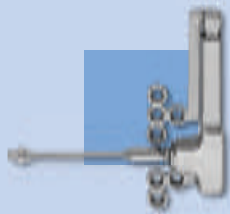

Vertikale Unterkieferdistraktoren
 Vertical mandibular distraction devices
 Distractores verticales para la mandíbula inferior
 Distracteurs mandibulaires verticales
 Distrattori mandibolari verticali



Parallele Unterkieferdistraktoren
 Parallel mandibular distraction devices
 Distractores paralelos para la mandíbula inferior
 Distracteurs mandibulaires parallèles
 Distrattori mandibolari paralleli



Medianer Unterkieferdistraktor
 Median mandibular distraction device
 Distractor mediano para la mandíbula inferior
 Distracteur mandibulaire médian
 Distrattore mandibolare mediano



Transantrale Oberkieferdistraktoren
 Transcranial maxilla distraction devices
 Distractores transantrales para el maxilar superior
 Distracteurs transantraux pour mâchoire supérieure
 Distrattori transcraniali per la mascella superiore



Unterkieferdistraktor für den Alveolarkammaufbau
 Mandibular distraction device for alveolar bone reconstruction
 Distractor mandibular para la reconstrucción de la cresta alveolar
 Distracteur mandibulaire pour la reconstitution de la crête alvéolaire
 Distrattore mandibolare per la ricostruzione della cresta alveolare

MEDICON

instruments

OMF SURGERY





SET SUGGESTIONS

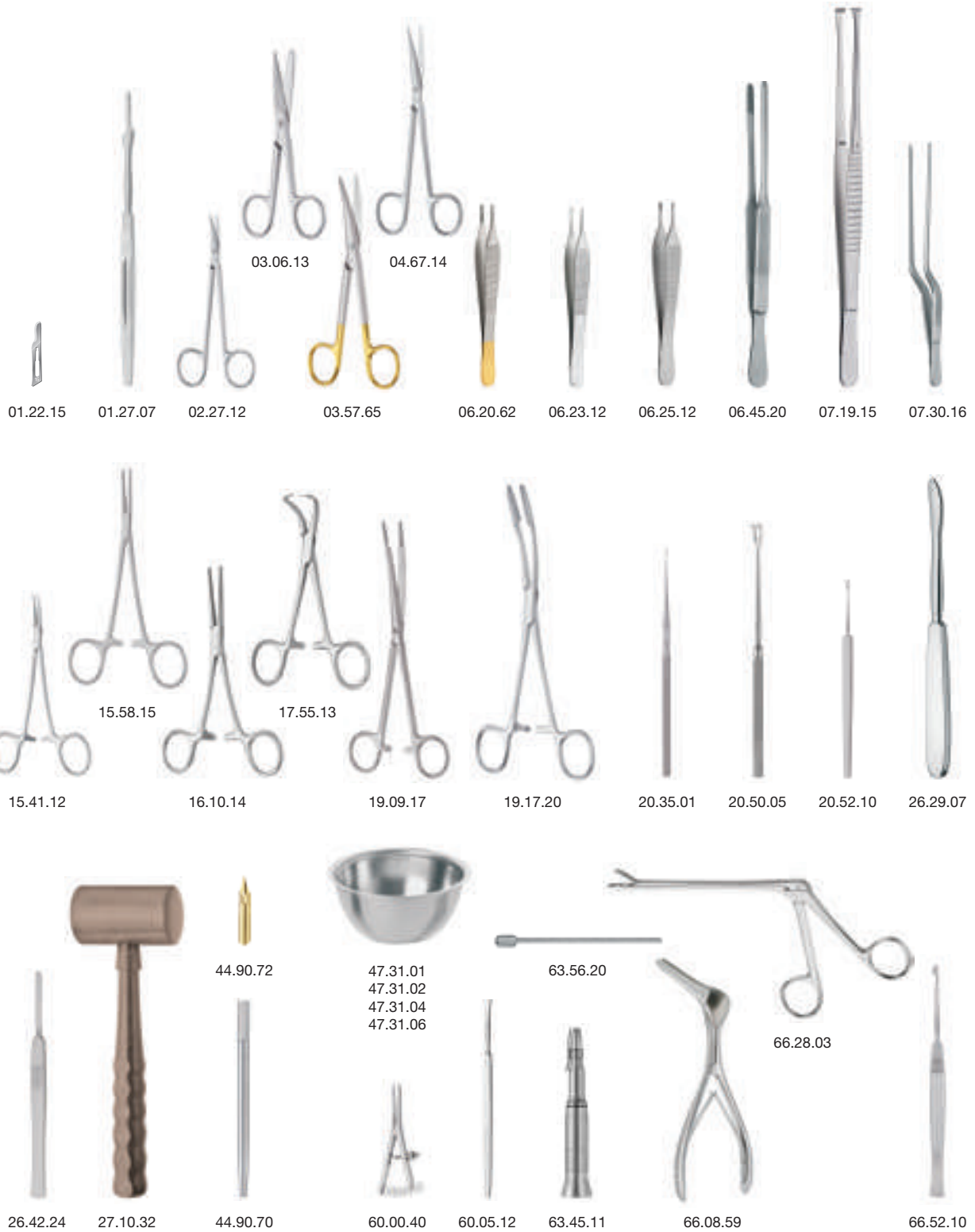



10.12.61

10.20.65



26.35.01

26.42.05



67.03.52

67.15.98

Part 1

“GUBISCH”

Item number	Description	Quantity
01.22.15	Scalpel blade · figure 15 · packing unit 100 pieces · sterile	1
01.27.07	Scalpel handle · no 7 · 16.5 cm	1
02.27.12	Delicate scissors · curved · sharp/sharp · 12 cm	1
03.06.13	Operating scissors · straight · sharp/blunt · 13 cm	1
03.57.65	MAYO-STILLE “HM” Dissecting scissors · curved · 15 cm	1
04.67.14	REYNOLDS (JAMESON) Dissecting scissors · curved · 14 cm	1
06.20.62	ADSON “HM” Dressing forceps · 12 cm	1
06.23.12	MICRO-ADSON Tissue forceps · 1 × 2 teeth · 12 cm	2
06.25.12	ADSON-BROWN Tissue forceps · 7 × 7 teeth · 12 cm	1
06.45.20	Dressing forceps · serrated · 20 cm	1
07.19.15	NELSON Tissue grasping forceps · 15 cm	1
07.30.16	GRUENWALD Forceps · serrated · 16 cm	1
10.12.61	GUBISCH “HM” Needle holder · fine · 12,5 cm	1
10.20.65	CRILE-WOOD “HM” (DEBAKEY “HM”) Needle holder · fine · 15 cm	1
15.41.12	MICRO-HALSTED Hemostatic forceps · curved · 12.5 cm	1
15.58.15	LERICHE Hemostatic forceps · straight · 1 × 2 teeth · 15 cm	1
16.10.14	PEAN Hemostatic forceps · straight · 14 cm	2
17.55.13	BACKHAUS Towel clamp · 13 cm	1
19.09.17	Dressing forceps · curved · 17.5 cm	1
19.17.20	GROSS Dressing forceps · curved · 20 cm	1
20.35.01	BARSKY Hook · 1 tooth · 15 cm	2
20.50.05	JOSEPH Hook · 2 teeth · 5mm · 17 cm	1
20.52.10	GUTHRIE Hook · 2 teeth · sharp · 1.5 mm · 13 cm	1
26.29.07	LANGENBECK Elevator · 7 mm · 20 cm	1
26.35.01	FREER Raspatory · sharp/sharp · 5 mm · 19 cm	1
26.42.05	WILLIGER Raspatory · 5 mm · 16 cm	1
26.42.24	McKENTY Raspatory · 4 mm · 15 cm	1
27.10.32	Mallet · made of Novotex plastic · Ø 45 mm · 240 g · 26 cm	1
44.90.70	GUBISCH Pen holder · 13 cm	1
44.90.72	Feather · no 46 · for marking · packing unit 10 pieces	1
47.31.01	Round bowl · Ø 40 mm · height 20 mm · 20 ml	1
47.31.02	Round bowl · Ø 60 mm · height 30 mm · 60 ml	1
47.31.04	Round bowl · Ø 80 mm · height 40 mm · 160 ml	1
47.31.06	Round bowl · Ø 110 mm · height 55 mm · 400 ml	1
60.00.40	CASTROVIEJO Caliper · measuring range 20 mm · 8 cm	1
60.05.12	DESMARRES Lid retractor · figure 2 · 14 mm · 14 cm	1
63.45.11	Hand piece · straight · 1:1 · 111 mm	1
• 63.45.13	Hand piece · straight · 1:1 · 131 mm	1
63.56.20	Cutting burr · barrel style · Ø 5 mm · shank Ø 2.35 mm · 7 cm	1
66.08.59	KILLIAN Nasal speculum · figure 4 · 90 mm · dismantable · 14 cm	1
66.28.03	WEIL-BLAKESLEY Nasal forceps · straight · 4.2 mm · 12 cm	1
66.52.10	FREER Mucosa knife · 16 cm	1
67.03.52	COTTLE Nasal speculum · 50 mm · 13 cm	1
67.15.98	HARALDSSON Suction elevator · Ø 3 mm · tube connection · 18.5 cm	1

Part 2 ▶



Instrumente, optional
Instruments, optional
Instrumentos, opcional
Instruments, optionnel
Strumenti, opzionale



67.19.75



67.19.80



67.20.07



67.21.33



67.30.15



67.30.22



67.30.53



67.33.03



67.53.71



67.58.42



67.61.00



67.61.01



67.61.03

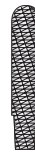

67.61.11



67.61.14



67.65.71



67.65.72



68.61.03



72.00.18



88.00.20



203.50.64



203.51.67



204.33.68



204.55.66



266.40.21



267.53.63



49.60.22



49.97.21
49.97.22



49.90.00

Part 2

“GUBISCH”



67.58.40



88.00.40

88.90.20



49.97.82

Item number	Description	Quantity
67.19.75	Cartilage cutting block · made of teflon · 87 × 55 × 12 mm	1
67.19.80	COTTLE Cartilage crusher	1
67.20.07	GUBISCH-KILNER Alar retractor · 10 mm · 8 cm	1
67.21.33	GUBISCH-AUFRICHT Nasal retractor · 17 cm	1
67.30.15	COTTLE-GUBISCH Chisel · graduated · hollow cut · 5 mm · 18 cm	1
67.30.22	COTTLE-GUBISCH Chisel · graduated · hollow cut · 12 mm · 18 cm	1
67.30.53	GUBISCH Osteotome · with aluminium handle · 3 mm · 18.5 cm	1
• 67.30.52	GUBISCH Osteotome · with aluminium handle · 2 mm · 18.5 cm	1
67.33.03	FANOUS-GUBISCH Osteotome · 4 mm · 19.5 cm	1
67.53.71	CAPLAN Nasal septum scissors · angled · 20 cm	1
67.58.40	AIACH Forceps · 16 cm	1
67.58.42	AIACH-GUBISCH Forceps · 16 cm	1
67.61.00	Handle for nasal rasps · 14 cm	1
67.61.01	Handle for nasal rasps · double-ended · 14 cm	1
67.61.03	Wrench · for nasal rasps	1
67.61.11	Rasps insert “HM” · figure 2	1
67.61.14	Rasps insert “HM” · figure 5	1
• 67.61.10	Rasps insert “HM” · figure 1	1
• 67.61.12	Rasps insert “HM” · figure 3	1
• 67.61.13	Rasps insert “HM” · figure 4	1
• 67.61.15	Rasps insert “HM” · figure 6	1
• 67.61.16	Rasps insert “HM” · figure 7	1
• 67.61.17	Rasps insert “HM” · figure 8	1
• 67.61.18	Rasps insert “HM” · figure 9	1
• 67.61.19	Rasps insert “HM” · figure 10	1
67.65.71	Protective cap · for Rubin Septal morselizer	1
67.65.72	GUBISCH-RUBIN “HM” Septal morselizer · 20 cm	1
68.61.03	LINDEMANN Burr · figure 3 · 4.5 cm	1
72.00.18	BUCHWALD Tongue spatula · 18/23 mm · 18 cm	1
88.00.20	Bipolar connecting cable · 3 m · Ø 12.5 mm	1
• 88.00.21	Bipolar connecting cable · 4 m · Ø 12.5 mm	1
• 88.00.22	Bipolar connecting cable · 3 m · Ø 4 mm	1
• 88.00.24	Bipolar connecting cable · 5 m · Ø 8 mm	1
88.00.40	Bracket · for one high frequency cable · 22.5 cm	1
88.90.20	BINNER Coagulation electrode · bipolar · 18.5 cm	1
203.50.64	MAYO Dissecting scissors · supercut plus · straight · 14 cm	1
203.51.67	MAYO Dissecting scissors · supercut plus · curved · 17 cm	1
204.33.68	METZENBAUM Dissecting scissors · supercut plus · curved · 18 cm	1
204.55.66	KELLY Dissecting scissors · supercut plus · curved · 16 cm	1
266.40.21	HEYMANN Rhinoplasty scissors · supercut · 18 cm	1
267.53.63	FOMON Rhinoplasty scissors · supercut plus · angled downwards · 13 cm	1
49.60.22	Medicontainer · 590 × 290 × 220 mm · silver	1
49.90.00	Tray · with silicone mat · 190 × 102 × 19 mm	1
49.97.21	Wire basket · 510 × 255 × 50 mm	2
49.97.22	Wire basket · 510 × 255 × 70 mm	2
49.97.82	Silicon mat · 13 mm · 467 × 240 mm	3



Instrumente, optional
Instruments, optional
Instrumentos, opcional
Instruments, optionnel
Strumenti, opzionale



01.22.10



01.27.03



02.50.03



06.31.20



07.00.10



09.83.30



10.12.63



15.45.12



19.17.20



20.31.15



20.48.10



60.00.40



60.05.11



60.55.40



67.58.54



202.50.13



49.50.10



49.97.02



17.55.08



204.11.11



49.97.62

Item number	Description	Quantity
01.22.10	Scalpel blade · figure 10 · sterile · packing unit 100 pieces	1
01.27.03	Scalpel handle · no 3 · standard · 12.5 cm	1
02.50.03	STEVENS scissors · curved · sharp · 11.5 cm	1
06.31.20	Iris forceps · half curved · 1 × 2 teeth · 10 cm	1
07.00.10	GRAEFE Fixation forceps · straight · 11 cm	1
09.83.30	FRAZIER (FERGUSSON) Suction cannula · 10 French · angled · 12.5 cm	1
10.12.63	HALSEY HM Needle holder · serrated · 13.5 cm	1
15.45.12	HALSTED-MOSQUITO Forceps · curved · 12.5 cm	2
17.55.08	BACKHAUS Towel clamp · 8.5 cm	4
19.17.20	GROSS Dressing forceps · curved · 20 cm	1
20.31.15	LAHEY-CLINIC Dura hook · 13 cm	2
20.48.10	BENICKE Retractor · 8 mm · sharp · 19 cm	1
60.00.40	CASTROVIEJO Caliper · 20 mm · 8 cm	1
60.05.11	DESMARRES Lid retractor · 12 mm · figure 1 · 14 cm	2
60.55.40	WALTER Lid forceps · 8 cm	1
67.58.54	ALAMUTI Marking forceps · 10 mm · 9.5 cm	1
202.50.13	STEVENS Scissors · supercut · curved · blunt · 11.5 cm	1
204.11.11	SIEGERT Scissors · supercut · curved · 11.5 cm	1
49.50.10	Medicontainer · 290 × 290 × 100 mm · silver	1
49.97.02	Wire basket · 240 × 255 × 50 mm	1
49.97.62	Silicone mat · 6 mm · 240 × 220 mm	1



09.87.00



09.87.14



09.87.53



09.87.54



09.87.73



09.87.80



09.87.85



09.87.86



09.87.93



09.87.97



09.88.01
09.88.02



09.88.46



09.88.83



49.50.10



09.87.88



49.97.02

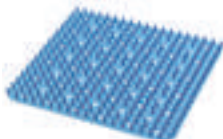

49.97.67

Item number	Description	Quantity
09.87.00	Liposuction cannula · Ø 3 mm · 20 cm	1
09.87.14	Liposuction cannula · Ø 3 mm · 20 cm	1
09.87.53	Liposuction cannula · Ø 1.7 mm · 15 cm	1
09.87.54	Liposuction cannula · Ø 2 mm · 15 cm	1
09.87.73	ENTNER Lipostructure cannula · angled · Ø 3 mm · 22 holes · 20 cm	1
09.87.80	Suction syringe · with vacuumstop · 10 ml	1
09.87.85	Connector · for handle · for liposuction cannula	1
09.87.86	Syringe rack · for liposuction syringe · Luer	1
09.87.88	ENTNER Lipostructure cannula · straight · Ø 2 mm · 8 holes · 15 cm	1
09.87.93	Lipo injection dosage handle · for 1 ml syringe	1
• 09.87.95	Lipo injection dosage handle · for 3 ml syringe	1
09.87.97	Syringe · for lipo injection · 3 ml · Luer · packing unit 100 pieces	1
09.88.01	Injection cannula · Ø 1.2 × 40 mm · packing unit 100 pieces	1
09.88.04	Injection cannula · Ø 2.0 × 60 mm · packing unit 100 pieces	1
09.88.46	Adaptor handle · with tube connector · rotating · with hole	1
09.88.83	Transfer adaptor · 2 × Luer/female · 75 mm	1
49.50.10	Mediccontainer · 290 × 290 × 100 mm · silver	1
49.97.02	Wire basket · 240 × 255 × 50 mm	1
49.97.67	Silicone mat · 13 mm · 240 × 220 mm	1



Instrumente, optional
Instruments, optional
Instrumentos, opcional
Instruments, optionnel
Strumenti, opzionale



Mikrochirurgischer Gaumenverschluss
Microsurgical Palate Closure
Cierre del paladar con microcirugía
Fermeture microchirurgicale du palais
Chiusura microchirurgica del palato



49.60.15



49.90.00



49.97.12



17.54.10

19.17.20



68.82.81

68.82.82



332.10.20

335.01.91

Item number	Description	Quantity
01.22.15	Scalpel blade · figure 15 · sterile · packing unit 100 pieces	1
01.27.07	Scalpel handle · no 7 · 16.5 cm	1
03.07.14	Operating scissors · curved · sharp/blunt · 14.5 cm	1
04.33.14	METZENBAUM Scissors · curved · 14 cm	1
04.71.19	DEMARTEL Vascular scissors · curved · 18 cm	1
06.01.14	Dressing forceps · medium width · 14.5 cm	1
06.35.58	SELECT Tissue forceps · 1 × 2 teeth · 18 cm	2
06.60.68	CUSHING "HM" Dressing forceps · with dissector end · 18 cm	1
09.79.85	Cannula with olive · curved · Ø 1.8 mm · 8 cm	2
09.84.08	PLESTER Suction tube · 8 French · working length 13.5 cm	1
11.34.68	TOENNIS "HM" Needle holder · 18 cm	1
15.44.12	HALSTED-MOSQUITO Hemostatic forceps · straight · 12.5 cm	4
17.54.10	TOHOKU Towel clamp · 10 cm	5
19.17.20	GROSS Dressing forceps · curved · 20 cm	1
20.30.20	GILLIES Delicate retractor · large · 19 cm	1
26.35.00	FREER-SCHEER Elevatory · 3.5 mm · double-ended · sharp/blunt · 19 cm	1
26.42.05	WILLIGER Raspatory · 5 mm · 16 cm	1
30.76.17	STELLBRINK Bone rongeur · light curved · 17 cm	1
45.52.30	KÖLN Mouth gag for children · complete	1
	consisting of:	
45.52.31	Frame with a pair of tooth hooks · curved	1
45.57.11	Tongue depressor · 65 × 28 mm	1
72.08.11	Tongue depressor · 55 × 25 mm	1
72.08.12	Tongue depressor · 60 × 27 mm	1
72.08.13	Tongue depressor · 70 × 30 mm	1
47.32.12	Round bowl · Ø 130 mm · height 35mm · 250 ml	1
60.34.21	BOWMAN (WILLIAMS) Lacrimal probe · nickel silver · figure 00-0 · 13 cm	1
68.01.44	OBWEGESER Soft tissue retractor · 42 × 10 mm · 22.5 cm	1
68.81.31	BLOCKSMA Cleft palate hook · 1 teeth · 18 cm	1
68.81.32	BLOCKSMA Cleft palate hook · 2 teeth · 3 mm · 18 cm	1
68.82.79	WANG Cleft palate raspatory · strong · curved · 15.5 cm	1
68.82.81	WANG Cleft palate raspatory · right · 18 cm	1
68.82.82	WANG Cleft palate raspatory · left · 18 cm	1
68.82.83	WANG Cleft palate raspatory · right · angled · 18 cm	1
68.82.84	WANG Cleft palate raspatory · left · angled · 18 cm	1
72.05.63	DENHART-HOEFERT Mouth gag · 12.5 cm	1
88.00.21	Bipolar connecting cable · Ø 12.5 mm · length 4 m	1
88.00.40	Bracket · for high frequency cable · 22.5 cm	1
88.20.08	Coagulation forceps · bipolar · angled · blunt · 20 cm	1
204.25.18	SLIM Dissecting scissors · supercut · curved · 18 cm	1
204.33.14	METZENBAUM Dissecting scissors · supercut · curved · 14 cm	1
204.51.15	JOSEPH Delicate dissecting scissors · supercut · curved · 15 cm	1
331.11.04	Mouth mirror · magnifying · figure 4 · Ø 22 mm · packing unit 12 pieces	1
331.50.10	Mouth mirror handle · 12 cm	1
332.10.20	LONDON-COLLEGE Dental plier · serrated · 15 cm	1
335.01.91	Dental probes · figure 9a · with point set in · 15 cm	1
49.60.15	Medicontainer · 590 × 290 × 150 mm · silver	1
49.90.00	Tray for delicate instruments with silicone mat · stackable · 190 × 102 × 19 mm	1
49.97.12	Wire basket · 480 × 255 × 50 mm	2



Lippen-, Kiefer- und Gaumenspalten
Lip, Jaw and Palate Fissures
Fisuras palatinas, labiales y maxilares
Fentes labiales, maxillaires et palatines
Labio-palatoschisi



Part 1

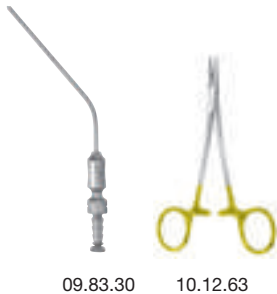

09.83.30

10.12.63



20.50.02

20.64.53



46.37.50



47.20.25

Item number	Description	Quantity
01.22.10	Scalpel blade · figure 10 · sterile · packing unit 100 pieces	1
01.22.11	Scalpel blade · figure 11 · sterile · packing unit 100 pieces	1
01.27.03	Scalpel handle · no 3 · standard · 12.5 cm	2
01.27.07	Scalpel handle · no 7 · long · 16.5 cm	2
03.51.64	MAYO "HM" Scissors · curved · 14.0 cm	1
06.20.12	ADSON Dressing forceps · serrated · 12 cm	1
06.25.12	ADSON Brown Tissue forceps · straight · 7 × 7 teeth · 12 cm	1
06.40.85	GILLIES Tissue forceps · 1 × 2 teeth · 15 cm	2
06.52.15	DEBAKEY AT Vascular forceps · 2.0 mm · 15 cm	1
06.60.92	GERALD Tissue forceps · straight · 1 × 2 teeth · 18 cm	1
09.08.16	Myrtle leaf probe · 16.0 cm	1
09.79.71	Infusion cannula · with olive · 1.2 × 80 mm	1
• 09.79.76	Infusion cannula · with olive · 2.0 × 80 mm	1
09.83.30	FRAZIER (FERGUSON) Suction cannula · 10 French · angled · 12.5 cm	1
10.12.63	HALSEY "HM" Needle holder · serrated · 13.5 cm	1
10.20.68	CRILE-WOOD "HM" (DEBAKEY "HM") Needle holder · fine · 18 cm	1
11.62.15	CASTROVIEJO Needle holder · curved · 14 cm	1
15.10.38	DIEFFENBACH Bulldog clamp · straight · 3.8 cm	2
15.35.09	HARTMANN (BABY MOSQUITO) Hemostatic forceps · 1×2 teeth · curved · 10 cm	4
15.41.82	MICRO-JACOBSON Hemostatic forceps · curved · 12.5 cm	4
15.45.22	Hemostatic forceps · ultra delicate · curved · 12.5 cm	1
16.40.18	HALSTEAD (ADSON) Hemostatic forceps · straight · 18 cm	2
17.55.10	BACKHAUS Towel clamp · 10.5 cm	2
19.09.17	Dressing forceps · curved · delicate · 17.5 cm	1
19.17.20	Gross Dressing forceps · curved · 20 cm	1
20.35.01	BARSKY Hook · 1 tooth · 15 cm	2
20.48.10	BENICKE Retractor · 8 mm · sharp · 19 cm	1
20.50.02	JOSEPH Hook · 2 teeth · 2 mm · 17 cm	2
20.64.53	Retractor · flexible · 3 teeth · sharp · 7 mm · 16 cm	2
26.35.02	FREER Periosteal elevator · sharp / blunt · 5.0 mm · 19 cm	1
26.37.12	BENNET Elevator · double-ended · figure 12s · 17 cm	2
26.37.90	MACDONALD Dissector · double-ended · 6 mm · 19 cm	1
26.40.06	KOENIG Raspatory · 5 mm · 15 cm	1
26.42.14	KAHRE Williger Raspatory · 4 mm · 16 cm	2
29.84.03	HEMINGWAY Sharp curette · double-ended · figure 3 · 18 cm	1
31.05.02	RUSKIN Mini Bone rongeur · 2 mm · curved · 15 cm	1
31.11.04	BEYER Bone rongeur · 4 mm · curved · 18 cm	1
44.37.15	Rule · stainless steel · 15 cm	1
45.52.02	DAVIS-MEYER Mouth gag · complete with frame and 7 tongue depressors	1
46.37.50	Needle case · Ø 65 mm	1
47.20.25	Kidney basin · 250 × 125 × 35 mm	1

Part 2 ▶



Instrumente, optional
Instruments, optional
Instrumentos, opcional
Instruments, optionnel
Strumenti, opzionale



Lippen-, Kiefer- und Gaumenspalten
Lip, Jaw and Palate Fissures
Fisuras palatinas, labiales y maxilares
Fentes labiales, maxillaires et palatines
Labio-palatoschisi

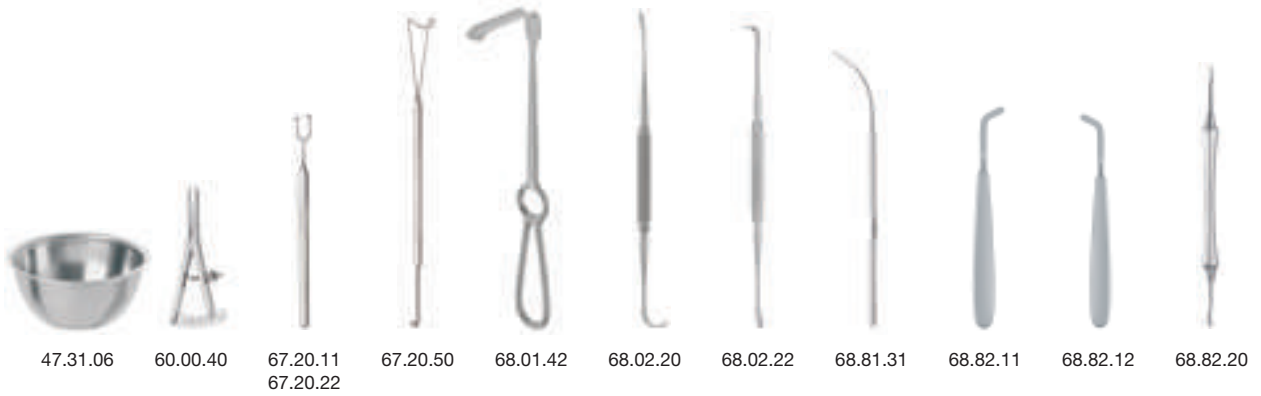

Part 2



68.82.80



88.00.40



49.97.21

Item number	Description	Quantity
47.31.06	Round bowl · Ø 110 mm · height 55 mm · 400 ml	1
60.00.40	CASTROVIEJO Caliper · 20 mm · 8 cm	1
67.20.11	COTTLE Skin hook · 2 teeth · sharp · 10 mm · 14 cm	1
67.20.22	COTTLE Skin hook · 2 teeth · sharp/ball tip · 10 mm · 14 cm	1
67.20.50	MASING Retractor · knife guide · 20 cm	2
68.01.42	OBWEGESER Soft tissue retractor · down · 7 × 25 mm	2
• 68.01.45	OBWEGESER Soft tissue retractor · down · 12 × 55 mm	1
• 68.01.46	OBWEGESER Soft tissue retractor · down · 14 × 70 mm	1
68.02.20	OBWEGESER-FREER Elevator · sharp/blunt · 21 cm	3
68.02.22	OBWEGESER-FREER Raspatory · double ended · 20.5 cm	1
68.81.31	BLOCKSMA Cleft palate hook · 1 tooth · 18 cm	1
• 68.81.32	BLOCKSMA Cleft palate hook · 2 teeth · 18 cm	1
68.82.11	Cleft palate raspatory · left · 14 cm	1
68.82.12	Cleft palate raspatory · right · 14 cm	1
68.82.20	KAHRE Cleft palate raspatory · 17 cm	4
68.82.80	WANG Cleft palate raspatory · 15.5 cm	1
68.82.81	WANG Cleft palate raspatory · right · 18 cm	1
68.82.82	WANG Cleft palate raspatory · left · 18 cm	1
68.82.83	WANG Cleft palate elevator · right · angled · 18 cm	1
68.82.84	WANG Cleft palate elevator · left · angled · 18 cm	1
72.05.63	DENHART-HOEFERT Mouth gag · 12.5 cm	1
72.08.00	DINGMAN Mouth gag · complete	1
	consisting of:	
72.08.20	Frame with 2 tooth hooks and 2 lateral cheek retractors	1
72.08.11	Tongue depressor · 55 × 25 mm	1
72.08.12	Tongue depressor · 60 × 27 mm	1
72.08.13	Tongue depressor · 70 × 30 mm	1
88.00.20	Bipolar cable · Ø 12.5 mm · 3 m	1
88.00.40	Bracket · for high frequency cable · 22.5 cm	1
88.17.08	Bipolar forceps · angled · blunt · 16.5 cm	2
204.11.11	SIEGERT Scissors · supercut · curved · 11.5 cm	2
204.13.13	RAGNELL (KILNER) Scissors · supercut · 13 cm	1
204.35.68	METZENBAUM-SLIM Scissors · supercut plus · curved · 18 cm	1
204.65.15	Dissecting scissors · supercut · delicate · curved · sharp · 15 cm	1
204.67.16	REYNOLDS · JAMESON Scissors · supercut · curved · 16 cm	1
331.11.04	Mouth mirror · magnifying · figure 4 · packing unit 12 pieces	1
331.50.20	Mouth mirror handle	1
49.60.17	Medicontainer · 590 × 290 × 170 mm · silver	1
49.97.21	Wire basket · 510 × 255 × 50 mm	3



Spongiosaentnahme aus dem Beckenkamm
Removal of Spongiosa from the Iliac Crest
Extracción de sustancia esponjosa de la cresta iliaca
Prélèvement d'os spongieux sur la crête iliaque
Prelievo di spongiosa dalla cresta iliaca



“CRISTACA”



20.30.20



47.31.02



47.30.08



49.50.15



49.97.02

Item number	Description	Quantity
01.22.10	Scalpel blade · figure 10 · sterile · packing unit 100 pieces	1
01.22.11	Scalpel blade · figure 11 · sterile · packing unit 100 pieces	1
01.27.03	Scalpel handle · no 3 · 12.5 cm	1
03.10.15	MIXTER Operating scissors · 15.5 cm	1
06.21.15	ADSON Tissue forceps · 1 x 2 teeth · 15 cm	1
06.22.15	MICRO-ADSON Dressing forceps · serrated · 15 cm	1
09.83.30	FRAZIER (FERGUSSON) Suction cannula · 10 French · working length = 12.5 cm	1
10.20.65	CRILE-WOOD “HM” (DEBAKEY “HM”) Needle holder · fine · 15 cm	1
15.44.12	HALSTED-MOSQUITO Hemostatic forceps · straight · 12.5 cm	1
15.72.64	CRILE Hemostatic forceps · straight · 14 cm	2
19.16.20	GROSS Dressing forceps · 20 cm	1
20.30.20	GILLIES Delicate retractor · 5 mm · 19 cm	2
22.16.14	ROUX Retractor · double-ended · 22 x 20 mm / 28 x 25 mm · figure 1 · 14 cm	1
23.25.07	LANGENBECK-KOCHER Retractor · 15 x 40 mm · 21 cm	1
24.22.13	WEITLANER Self-retaining retractor · sharp · 13 cm	1
24.26.13	WEITLANER-WULLSTEIN Self-retaining retractors · sharp · 13 cm	1
26.42.58	Raspatory · 8 mm · 17 cm	1
27.04.20	HAJEK Mallet · Ø 26 mm / 200 g · 21 cm	1
28.62.26	Iliac crest craft gouge with stop · 6 mm · 18 cm	1
29.51.60	Iliac crest curette with stop · 7 mm · figure 1 · 17 cm	1
46.35.22	Burr rack · for 6 burs up to 50 mm length · empty · 90 x 62 x 22 mm	1
47.30.08	Bowl · Ø 80 mm · height 35 mm · 100 ml	1
47.31.02	Bowl · Ø 60 mm · height 30 mm · 60 ml	1
47.50.60	Mixing cup with lid · Ø 37 mm · height 30 mm · 50 ml	1
63.45.11	Hand piece · straight · 1:1 · 111 mm	1
63.90.70	Trephine · Ø 7 mm · shaft Ø 2.35 mm · standard shank end · 44 mm	2
63.90.80	Trephine · Ø 10 mm · shaft Ø 2.35 mm · standard shank end · 44 mm	2
68.82.75	Bone mill with assembling wrench · Ø 68 mm · 11 cm	1
88.00.25	Bipolar connecting cable · coaxial connector Ø 12.5 mm · US-standard · 4 m	1
88.00.40	Bracket · for high frequency cable · 22.5 cm	1
88.07.08	Bipolar non-sticking forceps · 1.0 mm · 18 cm	1
204.33.18	METZENBAUM Dissecting scissors · supercut · curved · 18 cm	1
49.97.02	Wire baskets · 240 x 255 x 50 mm	2
49.50.15	Medicontainer · 290 x 290 x 150 mm · silver	1



Spongiosaentnahme aus dem Beckenkamm
Removal of Spongiosa from the Iliac Crest
Extracción de sustancia esponjosa de la cresta iliaca
Prélèvement d'os spongieux sur la crête iliaque
Prelievo di spongiosa dalla cresta iliaca



“SHEPARD”



19.16.20

22.16.14



78.41.12

78.41.15

Item number	Description	Quantity
01.22.10	Scalpel blade · figure 10 · sterile · packing unit 100 pieces	1
01.22.11	Scalpel blade · figure 11 · sterile · packing unit 100 pieces	1
01.27.03	Scalpel handle · no 3 · standard · 12.5 cm	1
01.27.07	Scalpel handle · no 7 · long · 16.5 cm	1
03.10.15	MIXTER Scissors · straight · 15.5 cm	1
06.21.15	ADSON Tissue forceps · 15 cm · 1 x 2 teeth · smooth	1
06.22.15	MICRO-ADSON Dressing forceps · serrated · 15 cm	1
09.83.30	FRAZIER (FERGUSSON) Suction cannula · 10 French · angled · 12.5 cm	1
10.20.65	CRILE-WOOD “HM” (DEBAKEY “HM”) Needle holder · fine · 15 cm	1
15.44.12	HALSTED-MOSQUITO Forceps · straight · 12.5 cm	2
19.16.20	GROSS Dressing forceps · straight · 20 cm	1
22.16.14	ROUX Retractor · figure 1 · 14.0 cm	1
24.22.13	WEITLANER Retractor · 3 x 4 teeth sharp · 13.0 cm	1
26.42.58	Raspatory · 8 mm · 17 cm	1
27.06.20	Mallet metal · with nylon facings · 200 g · 18.5 cm	1
27.57.06	MINI-LAMBOTTE Osteotome · 6 mm · 13 cm	1
• 27.57.08	MINI-LAMBOTTE Osteotome · 8 mm · 13 cm	1
• 27.57.10	MINI-LAMBOTTE Osteotome · 10 mm · 13 cm	1
28.62.06	MINI-LEXER Gouge · 6 mm · 18 cm	1
28.64.10	LEXER Chisel · 10 mm · 22 cm	1
• 28.64.20	LEXER Chisel · 20 mm · 22 cm	1
• 28.64.30	LEXER Chisel · 30 mm · 22 cm	1
28.94.20	LAMBOTTE Osteotome · straight · 20 mm · 24 cm	1
• 28.94.30	LAMBOTTE Osteotome · straight · 30 mm · 24 cm	1
29.49.03	Sharp curette · oval · 3 mm · 18.0 cm	1
78.41.02	SHEPARD Cortical cutter · only	1
78.41.05	SHEPARD Cylinder osteotome · Ø 5 mm · only	1
• 78.41.06	SHEPARD Cylinder osteotome · Ø 6 mm · only	1
• 78.41.08	SHEPARD Cylinder osteotome · Ø 8 mm · only	1
78.41.11	SHEPARD Cross pin · only	1
78.41.12	SHEPARD Ram · Ø 5 mm	1
• 78.41.13	SHEPARD Ram · Ø 6 mm	1
• 78.41.14	SHEPARD Ram · Ø 8 mm	1
78.41.15	SHEPARD Trocar · Ø 5 mm	1
• 78.41.16	SHEPARD Trocar · Ø 6 mm	1
• 78.41.18	SHEPARD Trocar · Ø 8 mm	1
204.33.18	METZENBAUM Scissors · supercut · curved · 18 cm	1
49.50.15	Mediccontainer · 290 x 290 x 150 mm · silver	1
49.97.02	Wire basket · 240 x 255 x 50 mm	2



Instrumente, optional
Instruments, optional
Instrumentos, opcional
Instruments, optionnel
Strumenti, opzionale

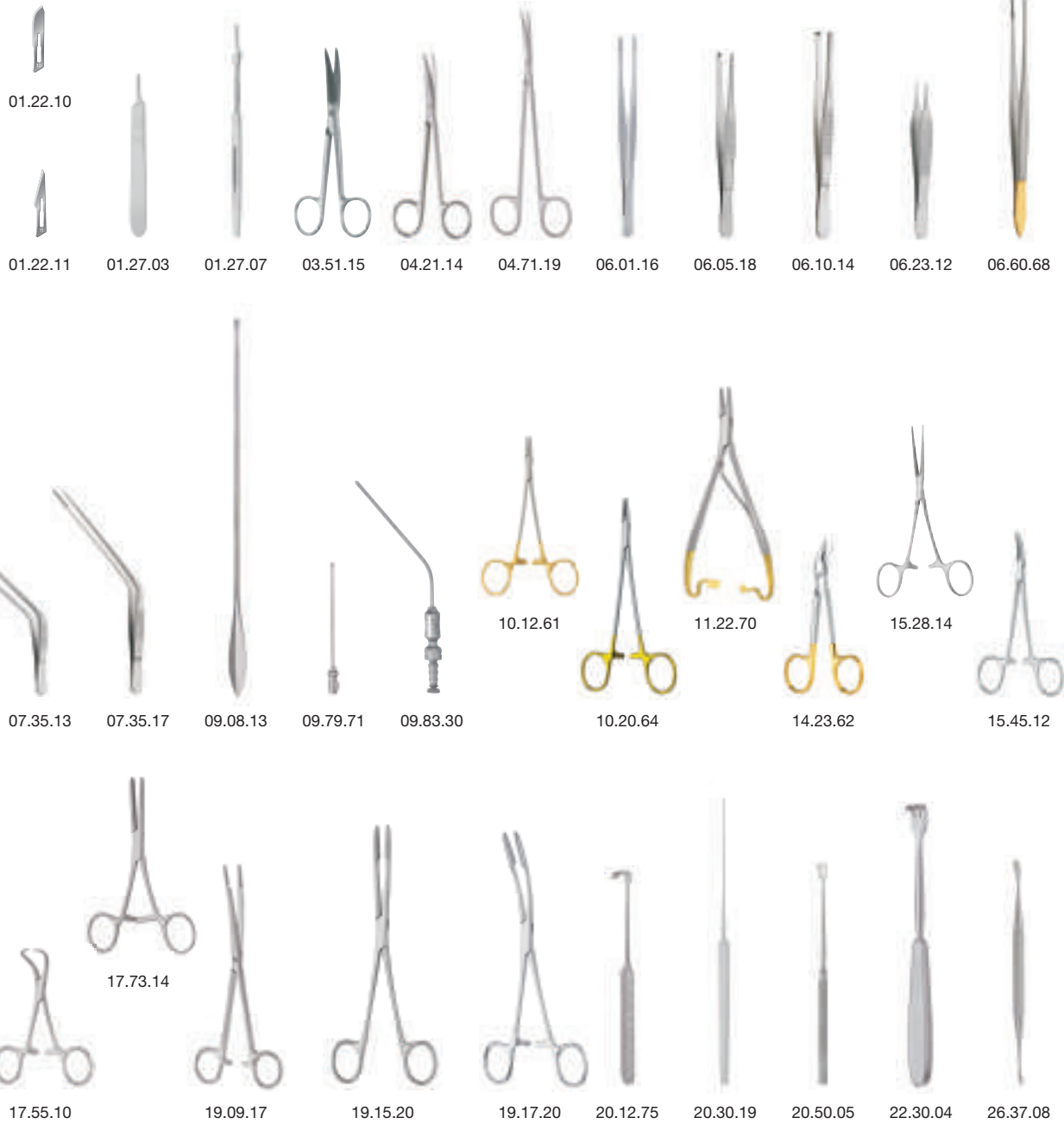

Part 1



06.60.92



15.57.15

16.64.18



26.42.05



26.42.58

Item number	Description	Quantity
01.22.10	Scalpel blade · figure 10 · sterile · packing unit 100 pieces	1
01.22.11	Scalpel blade · figure 11 · sterile · packing unit 100 pieces	1
01.27.03	Scalpel handle · no 3 · standard · 12.5 cm	1
01.27.07	Scalpel handle · no 7 · long · 16.5 cm	1
03.51.15	Mayo Scissors · curved · 15.5 cm	1
04.21.14	BROPHY (SULLIVAN) Scissors · curved · 14 cm	1
04.71.19	DEMARTEL Vascular scissors · curved · blunt · 18 cm	1
06.01.16	Dressing forceps · medium · 16.0 cm	1
06.05.18	Tissue forceps · 1 × 2 teeth · standard · 18.0 cm	1
06.10.14	Tissue forceps · 2 × 3 teeth · 14.5 cm	1
• 06.11.16	Tissue forceps · 3 × 4 teeth · 16.0 cm	1
06.23.12	MICRO-ADSON Tissue forceps · 1 × 2 teeth · 12 cm	2
06.60.68	CUSHING "HM" Dressing forceps · straight · 18 cm	2
06.60.92	GERALD Tissue forceps · straight · 1 × 2 teeth · 18 cm	1
07.35.13	TROELTSCH (WILDE) Ear forceps · 13 cm	1
07.35.17	TROELTSCH Nasal forceps · serrated · 17 cm	1
09.08.13	Myrtle leaf probe · 13.0 cm	1
09.79.71	Infusion cannula · with olive · 1.2 × 80 mm	1
• 09.79.76	Infusion cannula · with olive · 2.0 × 80 mm	1
09.83.30	FRAZIER (FERGUSON) Suction cannula · 10 French · angled · 12.5 cm	1
10.12.61	GUBISCH "HM" Needle holder · fine · 12.5 cm	1
10.20.64	BABY-CRILE-WOOD HM Needle holder · 15 cm	1
11.22.70	MATHIEU "HM" Needle holder · 20 cm	1
14.23.62	UNIVERSAL "HM" Wire cutting scissors · 12 cm	1
15.28.14	PEAN-BABY Hemostatic forceps · straight · 14 cm	2
15.45.12	HALSTEAD-MOSQUITO Forceps · curved · 12.5 cm	5
15.57.15	LERICHE Hemostatic forceps · curved · 15 cm	3
16.64.18	OVERHOLT-SLIM Forceps · 18.5 cm	1
17.55.10	BACKHAUS Towel clamp · 10.5 cm	4
17.73.14	Tubing clamp jaws · serrated · 14.5 cm	3
19.09.17	Dressing forceps · curved · delicate · 17.5 cm	1
19.15.20	GROSS Dressing forceps · curved · 20 cm	1
19.17.20	GROSS Dressing forceps · curved · 20 cm	1
20.12.75	STRANDELL-STILLE Retractor · 6 × 15 mm · 17 cm	2
20.30.19	GILLIES Hook · small · 19 cm	2
20.50.05	JOSEPH Hook · 2 teeth · 5 mm · 17 cm	1
22.30.04	VOLKMANN Retractor · 4 teeth · sharp · 18 mm · 21 cm	1
26.37.08	STILLER Raspatory · sharp · double-ended · 18 cm	1
26.42.05	WILLIGER Raspatory · 5 mm · 16 cm	1
26.42.58	Raspatory · 8 mm · 17 cm	1

Part 2 ▶



Instrumente, optional
Instruments, optional
Instrumentos, opcional
Instruments, optionnel
Strumenti, opzionale



26.60.35



27.10.32



27.57.04



27.61.03



27.95.03



28.62.08



29.51.51



29.69.52



29.83.72



30.25.30



44.90.72



44.90.70



47.20.25



47.31.02



47.45.12



60.00.40



60.00.42



60.05.95



67.02.35



67.37.25



68.01.35



68.01.45



68.01.72



68.01.80



68.01.82



35.15.18



66.52.10



66.54.10

Part 2

Item number	Description	Quantity
26.60.35	LANGENBECK Raspatory · 15 mm · 19 cm	1
27.10.32	Fibre mallet · Ø 45 mm · 240 g · 26 cm	1
27.57.04	MINI-LAMBOTTE Osteotome · 4 mm · 13 cm	1
• 27.57.06	MINI-LAMBOTTE Osteotome · 6 mm · 13 cm	1
• 27.57.08	MINI-LAMBOTTE Osteotome · 8 mm · 13 cm	1
27.61.03	PARTSCH Chisel · 3 mm · 14 cm	1
• 27.61.04	PARTSCH Chisel · 4 mm · 14 cm	1
• 27.61.06	PARTSCH Chisel · 6 mm · 14 cm	1
27.95.03	Bone tamper · Ø 3 mm · 16 cm	1
• 27.95.05	Bone tamper · Ø 6 mm · 16 cm	1
• 27.95.07	Bone tamper · Ø 7 mm · 16 cm	1
28.62.08	MINI-LEXER Gouge · 8 mm · 18 cm	1
29.51.51	VOLKMANN Sharp curette · figure 1 · 17 cm	1
• 29.51.55	VOLKMANN Sharp curette · figure 5 · 17 cm	1
29.69.52	HALLE Sharp curette · malleable · figure 2 · 21 cm	1
29.83.72	JANSEN Sharp curette · double-ended · 3/4 mm · 17 cm	1
30.25.30	BLUMENTHAL Bone rongeur · 30° · 16 cm	1
35.15.18	DINGMAN Bone holding forceps · 19 cm	1
44.90.70	GUBISCH Penholder · 13 cm	1
44.90.72	Feather · no 46 · for marking · packing unit 10 pieces	1
47.20.25	Kidney basin · 250 × 125 × 35 mm	1
47.31.02	Round bowl · Ø 60 mm · height 30 mm · 60 ml	1
• 47.31.04	Round bowl · Ø 80 mm · height 40 mm · 160 ml	1
47.45.12	Cotton container · with lid · 120 × 110 mm	1
60.00.40	CASTROVIEJO Caliper · 20 mm · 8 cm	1
60.00.42	CASTROVIEJO-EPKER Caliper · straight · 40 mm · 18 cm	1
60.05.95	JAEGER Lid plate · 11 cm	1
66.52.10	FREER Septum knife · D model · 16 cm	1
66.54.10	KILLIAN Septum elevator · double-ended · sharp/blunt · 18 cm	1
67.02.35	COTTLE Nasal speculum · figure 1 · 35 mm · 14 cm	1
• 67.02.55	COTTLE Nasal speculum · figure 2 · 55 mm · 14 cm	1
67.37.25	SCHROM Osteotome · with guide · 3 mm · straight · 19.5 cm	1
• 67.37.30	SCHROM Osteotome · with guide · 3 mm · left · 19.5 cm	1
• 67.37.35	SCHROM Osteotome · with guide · 3 mm · right · 19.5 cm	1
68.01.35	OBWEGESER Soft tissue retractor · up · 12 × 55 mm · 23 cm	1
• 68.01.37	OBWEGESER Soft tissue retractor · up · 16 × 80 mm · 23 cm	1
68.01.45	OBWEGESER Soft tissue retractor · down · 12 × 55 mm · 22.5 cm	1
• 68.01.47	OBWEGESER Soft tissue retractor · down · 16 × 80 mm · 22.5 cm	1
68.01.72	OBWEGESER Ramus clamp · wide · right · 19 cm	1
• 68.01.73	OBWEGESER Ramus clamp · wide · left · 19 cm	1
68.01.80	OBWEGESER Mandibular channel retractor · 8 mm · 17.5 mm	1
• 68.01.81	OBWEGESER Mandibular channel retractor · 10 mm · 17.5 mm	1
68.01.82	OBWEGESER Chin retractor · 16 cm	1

Part 3 ▶



Instrumente, optional
Instruments, optional
Instrumentos, opcional
Instruments, optionnel
Strumenti, opzionale



Part 3



68.05.30 68.18.91



88.00.40 88.17.08



49.97.21
49.97.22

Item number	Description	Quantity
68.01.99	Vestibulum retractor · universal · 15 cm	1
68.02.11	OBWEGESER Raspatory · curved · 15 mm · 20 cm	1
68.02.21	OBWEGESER-FREER Raspatory · double-ended · 21 cm	1
68.03.07	OBWEGESER-SPLITT osteotome · 7 mm · 21.5 cm	1
• 68.03.10	OBWEGESER-SPLITT osteotome · 10 mm · 21.5 cm	1
68.03.30	OBWEGESER Osteotome · 10 mm · curved · 23.5 cm	1
68.03.75	OBWEGESER Septal osteotome · 18.5 cm	1
68.04.05	OBWEGESER Mandibular awl · 14 cm	1
68.04.10	OBWEGESER Awl · for zygomatic arch · 23 cm	1
68.04.15	OBWEGESER Maxillary awl · 18 cm	1
68.05.20	WANGERIN Mandibular ramus positioning instrument · 18 cm	1
68.05.30	KRETSCHMER Retractor · with drill device · 12 × 60 mm · 21 cm	1
68.18.91	WASSMUND Retractor · 33 × 21 mm · 20.5 cm	1
72.00.50	BRUENINGS Tongue depressor · 14/18 mm · 19 cm	1
72.02.15	STERNBERG Cheek retractor · 14.5 cm	2
72.05.61	DENHART Mouth gag · delicate · catch · 12.5 cm	1
76.01.03	Suture wire · soft · 0.30 mm · coil / 10 m	1
• 76.01.04	Suture wire · soft · 0.40 mm · coil / 10 m	1
• 76.01.05	Suture wire · soft · 0.50 mm · coil / 10 m	1
77.10.20	DINGMAN Bone hook · 20 mm · 19 cm	1
87.32.12	Needle electrode · straight · Ø 4.0 mm	1
• 87.32.14	Needle electrode · angled · Ø 4.0 mm	1
87.33.70	Electrode handle · Ø 4.0 mm · with cable · 4.5 m	1
88.00.20	Bipolar cable · Ø 12.5 mm · 3 m	1
88.00.40	Bracket · for high frequency cable · 22.5 cm	1
88.17.08	Bipolar forceps · angled · blunt · 16.5 cm	1
204.11.11	SIEGERT Scissors · supercut · curved · 11.5 cm	1
204.33.18	METZENBAUM Scissors · supercut · curved · 18 cm	1
204.63.18	TOENNIS ADSON Scissors · supercut · curved · 18 cm	1
204.67.16	REYNOLDS (JAMESON) Scissors · curved · 16 cm	1
330.01.85	LUNIATSCHEK Gauze packers · blunt · 3 mm · 18 cm	2
331.10.03	Mouth mirror · plane · figure 3 · packing unit 12 pieces	1
331.50.20	Mouth mirror handle	1
332.10.21	London College Dental plier · smooth · 15 cm	1
335.01.91	Dental explorer · figure 9a · 15 cm	1
49.60.22	Medicontainer · 590 × 290 × 220 mm · silver	1
49.97.21	Wire basket · 510 × 255 × 50 mm	1
49.97.22	Wire basket · 510 × 255 × 70 mm	2



Instrumente, optional
Instruments, optional
Instrumentos, opcional
Instruments, optionnel
Strumenti, opzionale

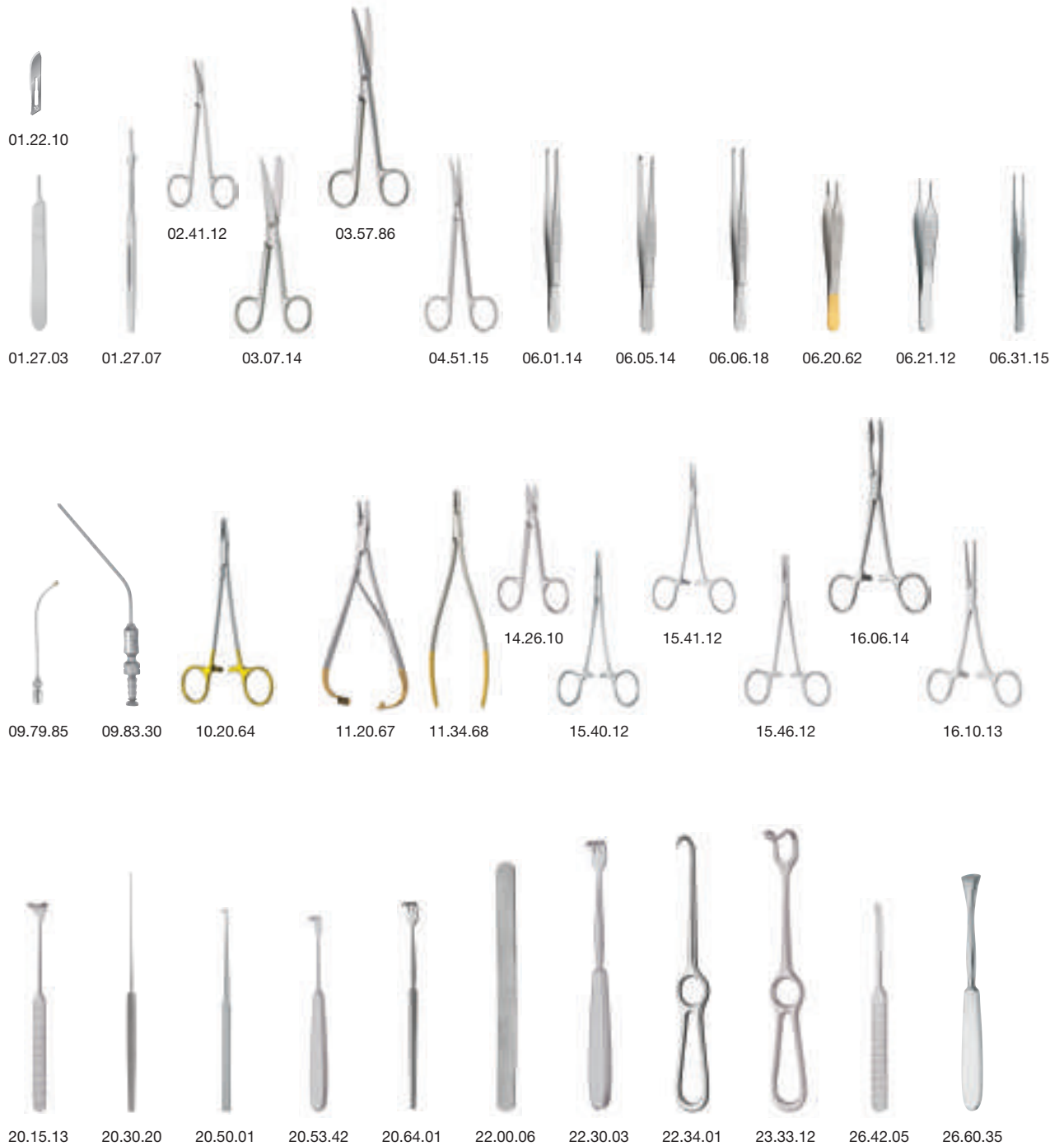

Part 1



06.52.15

07.30.16



17.55.10

19.17.20



29.83.72

35.15.19

Item number	Description	Quantity
01.22.10	Scalpel blade · figure 10 · sterile · packing unit 10 pieces	1
01.27.03	Scalpel handle · no 3 · standard · 12.5 cm	1
01.27.07	Scalpel handle · no 7 · long · 16.5 cm	1
02.41.12	Dissecting scissors · curved · 12 cm	1
03.07.14	Operating scissors · curved · sharp / blunt · 14.5 cm	1
03.57.86	LEXER Scissors · curved · 16 cm	1
04.51.15	JOSEPH Scissors · curved · 15 cm	1
06.01.14	Dressing forceps · medium · 14.5 cm	1
06.05.14	Tissue forceps · 1 × 2 teeth · standard · 14.5 cm	1
06.06.18	Tissue forceps · 1 × 2 teeth · medium · 18.0 cm	2
06.20.62	ADSON "HM" Dressing forceps · 12 cm	1
06.21.12	ADSON Tissue forceps · 1 × 2 teeth · smooth · 12 cm	1
06.31.15	SEMKEN Tissue forceps · straight · 1 × 2 teeth · 15 cm	1
06.52.15	DEBAKEY AT Vascular forceps · 2.0 mm · 15 cm	1
07.30.16	GRUENWALD Forceps · serrated · 16 cm	1
09.79.85	Infusion cannula · with olive · 1.8 × 80 mm · curved · Luer	1
09.83.30	FRAZIER (FERGUSON) Suction cannula · 10 French · angled · 12.5 cm	1
10.20.64	BABY-CRILE-WOOD "HM" Needle holder · 15 cm	1
11.20.67	MATHIEU "HM" Needle holder · 16 cm	1
11.34.68	TOENNIS "HM" Needle holder · 18 cm	1
14.26.10	BEEBEE Scissors · straight · sharp/sharp · 10.5 cm	1
15.40.12	MICRO-HALSTED Hemostatic forceps · straight · 12.5 cm	2
15.41.12	MICRO-HALSTED Hemostatic forceps · curved · 12.5 cm	2
15.46.12	HALESTED-MOSQUITO Forceps · straight · 1 × 2 teeth · 12.5 cm	2
16.06.14	PEAN Hemostatic forceps · short jaws · 14 cm	4
16.10.13	PEAN Hemostatic forceps · straight · 13 cm	2
17.55.10	BACKHAUS Towel clamp · 10.5 cm	6
19.17.20	GROSS Dressing forceps · curved · 20 cm	1
20.15.13	KOENIG Retractor · 13 × 10 mm · 17 cm	1
20.30.20	GILLIES Hook · large · 19 cm	2
20.50.01	JOSEPH Nasal hook · 1 teeth · 16 cm	2
20.53.42	Retractor · 2 teeth · 6 × 12 mm · 16 cm	2
20.64.01	Tracheal retractor · 1 tooth · sharp · 16 cm	1
22.00.06	Spatula · malleable · 6 × 200 mm	1
• 22.00.12	Spatula · malleable · 12 × 200 mm	1
• 22.00.17	Spatula · malleable · 17 × 200 mm	1
22.30.03	VOLKMANN Retractor · 3 teeth · sharp · 13 mm · 21 cm	2
22.34.01	VOLKMANN Retractor · 1 tooth · sharp · 22 cm	1
23.33.12	MIDDELDORPF Retractor 22 × 20 mm · 22.5 cm	1
26.42.05	WILLIGER Raspatory · 5 mm · 16 cm	1
26.60.35	LANGENBECK Raspatory · 15 mm · 19 cm	1
29.83.72	JANSEN Sharp curette · double-ended · 3 / 4 mm · 17 cm	1
35.15.19	DINGMAN Bone holding forceps · 19 cm	1

Part 2 ▶



Instrumente, optional
Instruments, optional
Instrumentos, opcional
Instruments, optionnel
Strumenti, opzionale



Part 2



68.02.00 68.02.02



72.05.63 77.10.10



49.60.22



49.97.21

Item number	Description	Quantity
35.24.20	SEMB Bone holding clamp · without catch · 20 cm	1
44.90.70	GUBISCH Penholder · 13 cm	1
44.90.72	Feather · no 46 · for marking · packing unit 10 pieces	1
47.20.25	Kidney basin · 250 × 125 × 35 mm	1
47.31.04	Round bowl · Ø 80 mm · height 40 mm · 160 ml	1
• 47.31.06	Round bowl · Ø 110 mm · height 55 mm · 400 ml	1
60.34.21	BOWMAN (WILLIAMS) Lacrymal probe · figure 00/0 nickel silver · 13 cm	1
66.08.03	KILLIAN Nasal speculum · figure 1 · 35 mm · 14 cm	1
68.01.05	OBWEGESER Retractor · 16 × 80 mm · 22 cm	1
68.01.25	OBWEGESER Ramus retractor · 11 × 70 mm · 22 cm	1
68.01.44	OBWEGESER Soft tissue retractor · down · 10 × 42 mm	1
• 68.01.46	OBWEGESER Soft tissue retractor · down · 14 × 70 mm	1
68.01.80	OBWEGESER Mandibular channel retractor · 8 mm · 17.5 cm	1
• 68.01.81	OBWEGESER Mandibular channel retractor · 10 mm · 17.5 cm	1
68.02.00	HOURIGAN Raspatory · round/pointed · 17.5 cm	1
68.02.02	OBWEGESER Raspatory · 7 mm · 17.5 cm	1
• 68.02.03	OBWEGESER Raspatory · 9 mm · 17.5 cm	1
68.02.12	OBWEGESER Raspatory · curved · 7 mm · 20 cm	1
68.02.21	OBWEGESER-FREER Raspatory · double ended · 21 cm	1
68.04.05	OBWEGESER Mandibular awl · 14 cm	1
68.04.10	OBWEGESER Awl · for zygomatic arch · 23 cm	1
68.04.15	OBWEGESER Maxillary awl · 18 cm	1
68.04.73	OBWEGESER "HM" Wire twister · 13 cm	1
68.05.20	WANGERIN Mandibular ramus positioning instrument · 18 cm	1
68.15.50	MERESHON Band pusher · 14.5 cm	1
68.18.92	DOCKHORN Cheek retractor · 40 × 12 mm · 21 cm	2
68.25.89	STEINHAEUSER Mandibular reduction clamp · 17.5 cm	2
72.01.15	TOBOLD Tongue depressor · 80 mm · 25 mm	1
72.05.63	DENHART-HOEFERT Mouth gag · 12.5 cm	1
77.10.10	DINGMAN Bone hook · 10 mm · 19 cm	1
88.00.20	Bipolar cable · Ø 12.5 mm · 3 m	1
88.00.40	Bracket · for high frequency cable · 22.5 cm	1
88.17.06	Bipolar forceps · straight · blunt · 16.5 cm	1
202.21.61	Iris Scissors · supercut plus · curved · 11.5 cm	1
204.33.14	METZENBAUM Scissors · supercut · curved · 14 cm	1
330.01.85	LUNIATSCHEK Gauze packers · blunt · 18 cm	1
331.11.04	Mouth mirror · magnifying · figure 4 · packing unit 12 pieces	1
331.50.20	Mouth mirror handle	1
332.10.20	LONDON-COLLEGE Dental plier · 15 cm	1
335.01.91	Dental explorer · figure 9a · 15 cm	1
390.70.20	Universal pin bending plier · 16 cm	1
49.60.17	Medicontainer · 590 × 290 × 170 mm · silver	1
49.97.21	Wire basket · 510 × 255 × 50 mm	3



Instrumente, optional
Instruments, optional
Instrumentos, opcional
Instruments, optionnel
Strumenti, opzionale

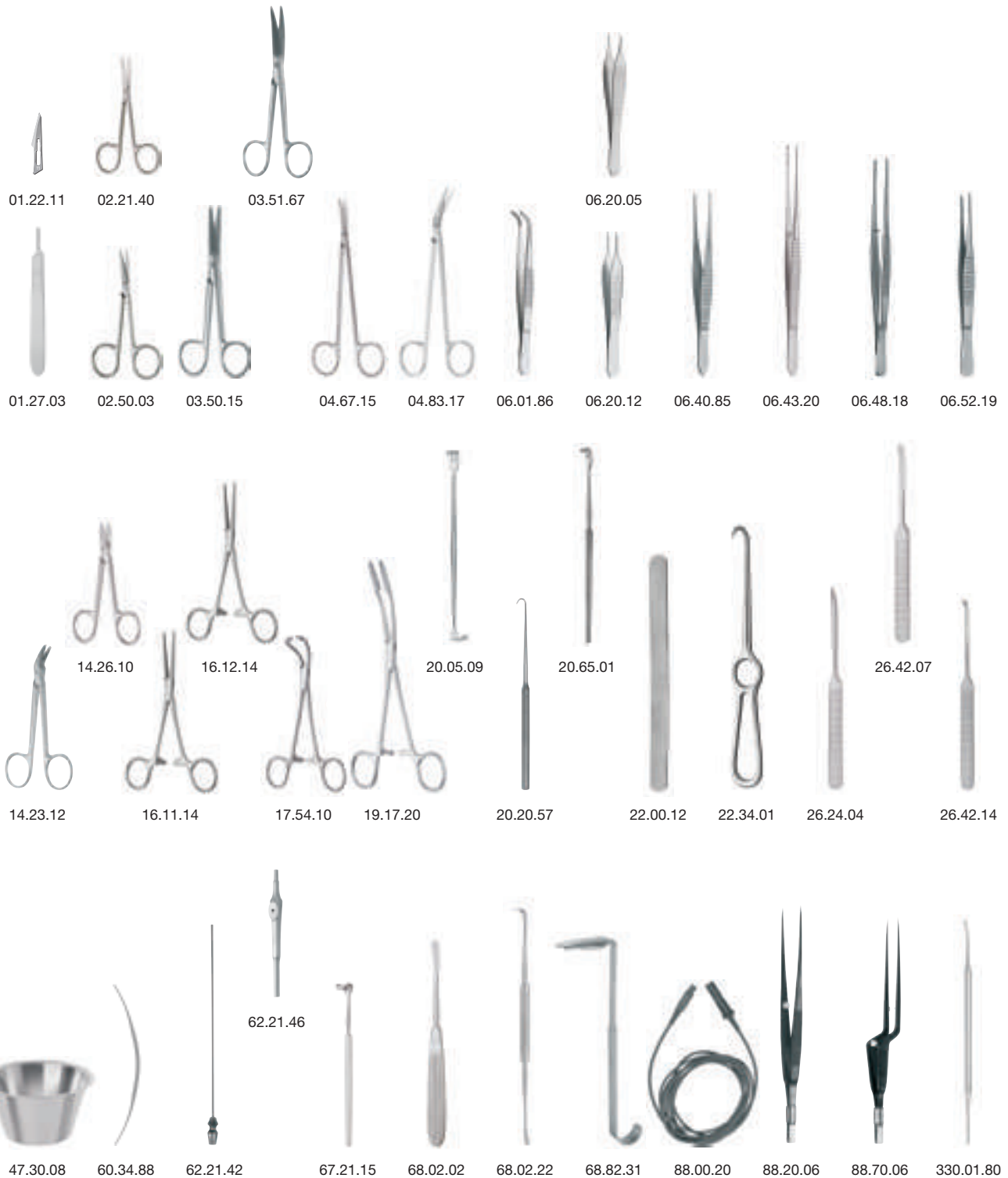



11.62.37



10.18.65



26.64.13



26.42.56



49.60.15



49.97.12

Item number	Description	Quantity
• 01.22.10	Scalpel blade · figure 10 · sterile · packing unit 100 pieces	1
01.22.11	Scalpel blade · figure 11 · sterile · packing unit 100 pieces	1
• 01.22.12	Scalpel blade · figure 12 · sterile · packing unit 100 pieces	1
01.27.03	Scalpel handle · no 3 · standard · 12.5 cm	1
02.21.40	IRIS SELECT scissors · curved · 10.5 cm	1
02.50.03	STEVENS scissors · curved · sharp · 11.5 cm	1
03.50.15	MAYO scissors · straight · 15 cm	1
03.51.67	MAYO "HM" scissors · curved · 17 cm	1
04.67.15	Dissecting scissors · curved · semi-blunt · 15 cm	1
04.83.17	LOCKLIN Scissors · one blade serrated · 16 cm	1
06.01.86	Dressing forceps · curved · medium with · 16 cm	1
06.20.05	HUDSON-EWALD Tissue forcep · 1 x 2 teeth · 12 cm	2
06.20.12	ADSON Dressing forceps · curved · serrated · 12 cm	2
06.40.85	GILLIES Tissue forceps · 1 x 2 teeth · 15 cm	1
06.43.20	WAUGH Tissue forceps · 1 x 2 teeth · cross threads · 20 cm	1
06.48.18	POTTS-SMITH Tissue forceps · 1 x 2 teeth · 18 cm	1
06.52.19	DEBAKEY AT Dressing forceps · 2.0 mm · 20 cm	1
10.18.65	MAYO-HEGAR "HM" Needle holder · straight · cross threads · 15 cm	1
11.62.37	CASTROVIEJO Needle holder · straight · cross threads · 17 cm	1
14.23.12	UNIVERSAL Wire cutting scissors · one blade serrated · 12 cm	1
14.26.10	BEEBEE Wire cutting scissors · straight · sharp · one blade serrated · 10.5 cm	1
16.11.14	PEAN AT Hemostatic forceps · curved · 14 cm	1
16.12.14	KOCHER AT Intestinal clamp · straight · 1 x 2 teeth · 14 cm	1
17.54.10	TOHOKU Towel clamp · curved · cross threads · 10 cm	1
19.17.20	GROSS Dressing forceps · curved · 20 cm	1
20.05.09	SENN-MILLER Delicate retractor · double-ended · blunt	1
20.20.57	Delicate Retractor · 7 mm · blunt · 16 cm	1
20.65.01	Delicate Retractor · 9 mm · blunt · 1 tooth · 16 cm	1
22.00.12	Spatula · malleable · 12 x 200 mm	1
• 22.00.17	Spatula · malleable · 17 x 200 mm	1
• 22.00.25	Spatula · malleable · 25 x 200 mm	1
22.34.01	VOLKMANN Retractor · sharp · curved · 22 cm	1
26.24.04	WILLIGER Elevator · 4 mm · blunt · 17 cm	1
26.42.07	WILLIGER Raspatory · 7 mm · sharp · 16 cm	1
26.42.14	KAHRE-WILLIGER Raspatory · 4 mm · sharp · 16 cm	1
26.42.56	Raspatory · 6 mm · sharp · curved · 17 cm	1
26.64.13	Raspatory · 3 mm · sharp · curved · 18.5 cm	1
47.30.08	Round bowl · Ø 80 mm · height 35 mm · 100 ml	1
60.34.88	ZIEGLER Lacrymal probe · 11 cm	2
62.21.42	WULLSTEIN Suction tube · Ø 2.0 mm · sterling silver · malleable · luer · 14 cm	2
62.21.46	WULLSTEIN Suction handle · luer	2
67.21.15	COTTLE Nasal retractor · 14 cm	1
68.02.02	OBWEGESER Raspatory · 7 mm · sharp · 17.5 cm	1
68.02.22	OBWEGESER-FREER Raspatory · sharp / blunt · 20.5 cm	1
68.82.31	KLUBA Orbital hook · small · 19 cm	1
• 68.82.32	KLUBA Orbital hook · medium · 19 cm	1
• 68.82.33	KLUBA Orbital hook · large · 19 cm	1
88.00.20	Bipolar cable · Ø 12.5 mm · 3 m	1
88.20.06	Bipolar forceps · straight · blunt · 20 cm	1
88.70.06	Bipolar forceps · bajonet · straight · 19 cm	1
330.01.80	LUNIATSCHEK Gauze packer · sharp · 18cm	1
• 330.01.85	LUNIATSCHEK Gauze packer · blunt · 18cm	1
49.60.15	Medic container · 590 x 290 x 150 mm · silver	1
49.97.12	Wire basket · 480 x 255 x 50 mm	2



Instrumente, optional
Instruments, optional
Instrumentos, opcional
Instruments, optionnel
Strumenti, opzionale



01.22.11



01.27.17



01.30.38



09.83.07



12.18.74



13.71.58



26.37.08



63.45.11



63.54.30



68.82.53



68.82.56



68.82.57



68.82.58



205.18.71



49.90.04



29.68.42



49.50.10



49.97.02

Item number	Description	Quantity
01.22.11	Scalpel blade · fig. 11 · sterile · packing unit 100 pieces	1
01.27.17	Scalpel handle · no 7K · 12 cm	1
01.30.38	BLAKE Blade holder · angled · 15.5 cm	1
09.83.07	STILLER Suction cannula · 6 French · angled · 12.5 cm	1
12.18.74	MICRO 2000 Needle holder · straight · with catch · 18 cm	1
13.71.58	MICRO Suture forceps · straight · 1 × 2 teeth · 15 cm	1
26.37.08	STILLER Raspatory · sharp · double ended · 18 cm	1
29.68.42	DAUBENSPECK Sharp curette · figure 00 · 20 cm	1
63.45.11	Hand piece · straight · 1:1 · 111 mm	1
63.54.30	Diamond burr · 70 mm · 3.0 mm	1
68.82.53	STILLER Elevator · for sinuslift · 3 mm · double ended	3
• 68.82.54	STILLER Elevator · for sinuslift · 4 mm · double ended	1
• 68.82.55	STILLER Elevator · for sinuslift · 6 mm · double ended	1
68.82.56	STILLER Elevator · for sinuslift · 3 mm · 90° · double ended · 20 cm	1
68.82.57	STILLER Elevator · for sinuslift · retrograde · double ended · 22 cm	1
68.82.58	STILLER Elevator · for sinuslift · double ended · 18 cm	1
205.18.71	MICRO 2000 Scissors · supercut · curved · 18 cm	1
49.50.10	Medicontainer · 290 × 290 × 100 mm · silver	1
49.90.04	Tray · with fixation strips · for 12 instruments	1
49.97.02	Wire basket · 240 × 255 × 50 mm	1

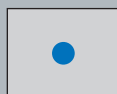

Instrumente, optional
 Instruments, optional
 Instrumentos, opcional
 Instruments, optionnel
 Strumenti, opzionale

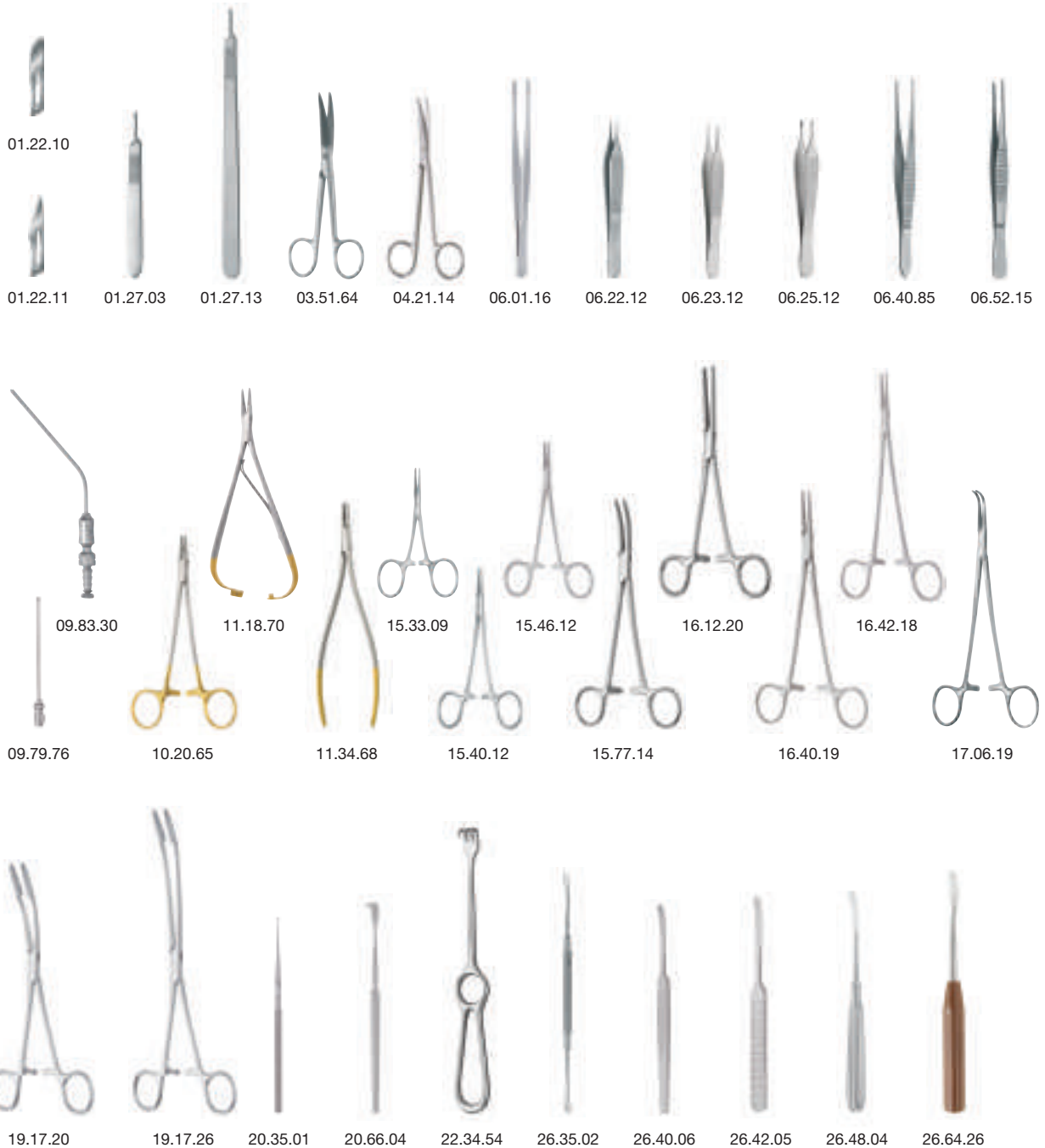

Part 1



06.60.92

07.10.15

09.08.14



17.07.50

17.55.20

19.09.17



29.48.03

29.83.62

29.83.72

Item number	Description	Quantity
01.22.10	Scalpel blade · figure 10 · sterile · packing unit 100 pieces	1
01.22.11	Scalpel blade · figure 11 · sterile · packing unit 100 pieces	1
01.27.03	Scalpel handle · no 3 · standard · 12.5 cm	2
01.27.13	Scalpel handle · no 3L · standard · 12.5 cm	1
03.51.64	MAYO "HM" Scissors · curved · 14 cm	1
04.21.14	BROPHY (SULLIVAN) Scissors · curved · 14 cm	1
06.01.16	Dressing forceps · medium · 16 cm	1
06.22.12	MICRO-ADSON Dressing forceps · serrated · 12 cm	1
• 06.22.15	MICRO-ADSON Dressing forceps · serrated · 15 cm	1
06.23.12	MICRO-ADSON Tissue forceps · 1 × 2 teeth · 12 cm	2
06.25.12	ADSON-BROWN Tissue forceps · straight · 7 × 7 teeth · 12 cm	1
06.40.85	GILLIES Tissue forceps · 1 × 2 teeth · 15 cm	2
06.52.15	DEBAKEY AT Vascular forceps · 2 mm · 15 cm	1
06.60.92	GERALD Tissue forceps · straight · 1 × 2 teeth · 18 cm	2
07.10.15	BROWN Grasping forceps · 15 cm	1
09.08.14	Myrtle leaf probe · 14.5 cm	2
09.79.76	Infusion cannula · with olive · 2.0 × 80 mm	2
09.83.30	FRAZIER (FERGUSON) Suction cannula · 10 French · angled · 12.5 cm	1
10.20.65	CRILE-WOOD "HM" (DEBAKEY "HM") Needle holder · fine · 15 cm	2
• 10.20.68	CRILE-WOOD "HM" (DEBAKEY "HM") Needle holder · fine · 18 cm	1
11.18.70	MATHIEU-KOCHER "HM" Needle holder · 20 cm	1
11.34.68	TOENNIS "HM" Needle holder · 18 cm	1
15.33.09	HARTMANN (BABY MOSQUITO) Hemostatic forceps · curved · 10 cm	2
15.40.12	MICRO-HALSTED Hemostatic forceps · straight · 12.5 cm	6
• 15.41.12	MICRO-HALSTED Hemostatic forceps · curved · 12.5 cm	6
15.46.12	HALSTED-MOSQUITO Forceps · straight · 1 × 2 teeth · 12.5 cm	6
15.77.14	SPENCER-WELLS Hemostatic forceps · curved · 14 cm	6
16.12.20	ROCHESTER-OCHSNER Hemostatic forceps · 1 × 2 teeth · straight · 20 cm	2
16.40.19	ADSON Hemostatic forceps · straight · 18.5 cm	2
16.42.18	HALSTED (ADSON) Hemostatic forceps · 1 × 2 teeth · straight · 18 cm	2
17.06.19	MIXTER-BABY Forceps · 19 cm	1
17.07.50	O'SHAUGNESSY Hemostatic forceps · curved · 20 cm	1
17.55.20	BACKHAUS Towel clamp · with ball · 11 cm	4
19.09.17	Dressing forceps · curved · delicate · 17.5 cm	1
19.17.20	GROSS Dressing forceps · curved · 20 cm	1
19.17.26	MAIER Dressing forceps · curved · 26 cm	2
20.35.01	BARSKY Skin hook · 1 tooth · 15 cm	2
20.66.04	Tracheal retractor · 4 teeth · sharp · 1 mm · 16 cm	2
22.34.54	VOLKMANN Retractor · 4 teeth · semisharp · 18 mm · 22 cm	2
26.35.02	FREER Periosteal elevator · sharp/blunt · 5.0 mm · 19 cm	1
26.40.06	KÖNIG Raspatory · 5 mm · 15 cm	2
26.42.05	WILLINGER Raspatory · 5 mm · 16 cm	1
26.48.04	ADSON Raspatory · 6 mm · straight · sharp · 17 cm	1
26.64.26	Raspatory · 6 mm · 18.5 cm	1
29.48.03	SHARP Curette · round · Ø 3 mm · 17 cm	1
29.83.62	WILLIGER Sharp curette · double-ended · angled · 14 cm	1
29.83.72	JANSEN Sharp curette · double-ended · 3/4 mm · 17 cm	1

Part 2 ▶



Instrumente, optional
Instruments, optional
Instrumentos, opcional
Instruments, optionnel
Strumenti, opzionale



Part 2



68.01.99

68.02.22



204.33.63

204.35.68

Item number	Description	Quantity
30.71.03	BEYER Bone rongeur · 3 mm · curved · 17 cm	1
44.37.15	Rule · stainless steel · 15 cm	1
46.37.50	Needle case · Ø 65 mm	1
47.20.25	Kidney basin · 250 × 125 × 35 mm	1
52.46.50	MUSEUX Uterine tenaculum forceps · 2 × 2 teeth · 20 cm	1
57.31.59	OLIVECRONA Spatula · 7 + 9 mm · straight · 18 cm	1
• 57.31.63	OLIVECRONA Spatula · 11 + 13 mm · straight · 18 cm	1
• 57.31.68	OLIVECRONA Spatula · 15 + 18 mm · straight · 18 cm	1
• 57.31.72	OLIVECRONA Spatula · 18 + 22 mm · straight · 18 cm	1
60.05.12	DESMARRES Lid retractor · 14 mm · figure 2 · 14 cm	2
60.34.22	BOWMAN (WILLIAMS) Lacrymal probe · figure 1/2 · 13 cm · nickel silver	2
68.01.41	OBWEGESER Soft tissue retractor · down · 5 × 18 mm	2
• 68.01.42	OBWEGESER Soft tissue retractor · down · 7 × 25 mm	2
• 68.01.43	OBWEGESER Soft tissue retractor · down · 10 × 35 mm	2
• 68.01.44	OBWEGESER Soft tissue retractor · down · 10 × 42 mm	2
68.01.99	Vestibulum Retractor universal · 15 cm	1
68.02.22	OBWEGESER-FREER Elevator · double ended · 20.5 cm	1
72.00.50	BRUENINGS Tongue depressor · 14/18 mm · 19 cm	1
72.01.15	TOBOLD Tongue depressor · 80 mm · 25 mm	1
72.05.61	DENHART Mouth gag · 12.5 cm	1
88.00.20	Bipolar cable · Ø 12.5 mm · 3 mm	1
88.00.40	Bracket · for high frequency cable · 22.5 cm	1
88.12.06	Bipolar forceps straight · blunt · 11 cm	2
202.21.10	Iris scissors · supercut · straight · 10.5 cm	2
204.33.63	METZENBAUM Scissors · supercut plus · curved · 14 cm	1
204.35.68	METZENBAUM-SLIM Scissors · supercut plus · curved · 18 cm	1
204.67.16	REYNOLDS (JAMESON) Scissors · supercut · curved · 16 cm	1
330.01.85	LUNIATSCHEK Gauze packers · blunt · 3 mm · 18 cm	1
• 330.01.86	LUNIATSCHEK Gauze packers · sharp · 2 mm · 18 cm	1
331.10.03	Mouth mirror · plane · figure 3 · packing unit 12 pieces	1
331.50.10	Mouth mirror handle	2
332.10.22	LONDON-COLLEGE Dental plier · 15 cm	1
335.01.91	Dental explorer · figure 9a · 15 cm	1
49.60.17	Medicontainer · 590 × 290 × 170 mm · silver	1
49.97.21	Wire basket · 510 × 255 × 50 mm	3



Instrumente, optional
Instruments, optional
Instrumentos, opcional
Instruments, optionnel
Strumenti, opzionale

MEDICON

instruments

OMF SURGERY





ALPHABETICAL INDEX



A	
Adaptierungsklemmen	97
ADSON Anatomische Pinzette	28
ADSON-BABY Präparierklemmen	43
ADSON Elevatorium	88
ADSON "HM" Anatomische Pinzette	28
ADSON MICRO Anatomische Pinzette	29
ADSON Raspatorien	83
ADSON-TOENNIS Präparierscheren	24
Ahlen	113
Alveolar-Haken	64
Anatomische Pinzetten	27-30
Anmischbecher	124
Anschlusskabel	35
Antihaft-Pinzetten bipolar	33-34
Arterienklemmen	41-42
AUFRICHT-GUBISCH Nasenhaken	74
AUFRICHT Nasenhaken	74
B	
BABY ADSON Präparierklemmen	43
BABY-CRILE-WOOD "HM" Nadelhalter	37
BABY-METZENBAUM Feine Präparierscheren	24
BABY-MOSQUITO-HARTMANN Arterienklemmen	41
BACKHAUS-ROEDER Tuchklemmen	44
BACKHAUS Tuchklemmen	43-44
Bajonettpinzette	29
BARSKY Hauthäkchen	56
Beckenkamminstrumente	124-125
BENICKE Feine Wundhaken	55
BENNET Elevatorium	87
BEUSE Feine Präparierscheren	23
BEYER Hohlmeißelzangen	103-104
Bipolare Anschlusskabel	35
Bipolare Antihaft-Pinzetten	33-34
BLAKE Skalpellgriff	14
BLAKESLEY WEIL Siebbeinzangen	106
Blattosteotome	93
BLOCKSMA Häkchen	115
BLUME Osteotome	95
BLUMENTHAL Hohlmeißelzangen	103
Blutstillungsmeißel	107
Bohrerstände	124
BOWMAN Tränenkanalsonden	49
BOWMAN (WILLIAMS) Tränenkanalsonden	49
BROWN Gewebefasspinzetten	32
BRÜNINGS Flachmeißel	92
BRÜNINGS Zungenspatel	75
BUCHWALD Zungenspatel	75
Bulldog-Klemmen	41

C	
CASTROVIEJO-EPKER Zirkel	109
CASTROVIEJO Zirkel	109
CAWOOD Wangenhalter	72
Chirurgische Handstücke	131
Chirurgische Pinzetten	29-31
Chirurgische Scheren	22-23
CINELLI Osteotome	95
CLAUDINHA Zungenspatel	80
COLLIN Wundhaken	69
COLLIN Zungenzangen	78
COTTLE-MEDICON Osteotome	91
COTTLE Osteotome	94
CRILE-WOOD BABY HM Nadelhalter	38
CRILE-WOOD HM Nadelhalter	37
CRILE-WOOD Nadelhalter	37
CUSHING Chirurgische Pinzetten	30
CUSHING HM Anatomische Pinzetten	30
CUSHING Nervhäkchen	54
CUSHING (TAYLOR) Bajonettpinzette	29
CUSHING Venenhaken	54-55
D	
DANDY Arterienklemmen	41
DAUBENSPECK Scharfe Löffel	89
DAUTREY Drahtbügelschiene	111
DEAN Tonsillenschere	21
DEBAKEY HM Nadelhalter	38
DENHART-HOEFERT Mundsperrer	80
DENHART Mundsperrer	80
DESMARRES Lidhalter	73
DIEFFENBACH Bulldog Klemme	41
DINGMAN Jochbogenelevatorium	88
DINGMAN Knochenhalte-zangen	101
DINGMAN Mundsperrer	79
DINGMAN Raspatorium	82
DINGMAN Zungendrucker	77, 117
DOCKHORN Wangenhalter	72
DOUGHTY KILNER Zungendrucker	77, 117
DOYEN Zungenspatel	75
Drahtbögen	111
Drahtbügelschiene	111
Drahtdrehklemme	113
Drahtinstrumente	112-114
Drahtösenklemme	113
Drahtpositionierer	112
Drahtscheren	114
Drahtschneidezangen	114
E	
Elevatorien	87-88, 115
Elevatorium Jochbogen	88

EPKER-CASTROVIEJO Zirkel	109
ERICH Drahtbögen	111
Extraorale Retraktoren	68

F

Feine Präparierscheren	20, 23-24
Feine Scheren	20
Feine Wundhaken	54-58
FERGUSON-FRAZIER Saugkanüle	47
Fibula-Raspatorium	128
Flachmeißel	91-92
Flachzangen	112
FOX Zahnfleissscheren	21
Fräser	131
Fragment-Adaptierungsklemmen	97
FRAZIER (FERGUSON) Saugkanüle	47
FRAZIER Hauthäkchen	56
FRAZIER Saugkanülen	47
FREER Elevatorien	87
FREER OBWEGESER Elevatorium	87
FREER OBWEGESER Raspatorien	82
FREER Raspatorium	86
FREER-SCHEER Elevatorium	115
FROHN Watteträger	50

G

Gaumenspalteninstrumente	115-117
Gaumenspalten Raspatorien	115
GERALD Anatomische Pinzetten	30
Gewebefasspinzetten	32
GILLIES Chirurgische Pinzetten	31
GILLIES Elevatorium	88
GILLIES Feine Wundhaken	56
GILLIES HM Nadelhalter	38
GROSS Kornzangen	45
GUBISCH-AUFRIECHT Nasenhaken	74
GUTHRIE Feine Wundhaken	56

H

HAJEK Hammer	90
HAJEK-KOFLER Stanze	107
Häkchen Haut	56
Häkchen Nerv	54
Hämmer	90
Haken Mobilisation	98
Haken Nase	74
Haken Orbita	73
Haken Ramus	66
Haken Spina-nasalis	65
Haken Venen	54-55
Haken Weichteil	67
HAKIM Fibula Raspatorium	128

HALSTED-MOSQUITO Arterienklemmen	42
Halteklammer	35
Halter Lid	73
Halter Lippen	71-72
Halter Wangen	71-72
Handstücke	131
HANNA Zungenspatel	80
HARALDSSON Sauglevatorium	47
HARTMANN (BABY-MOSQUITO) Arterienklemmen	41
HARTMANN Zungendrucker	78
Hauthäkchen	56
HEGAR-MAYO HM Nadelhalter	37
HM Drahtschneidezangen	114
HM Raspelaufsatz	137
HOEFERT DENHART Mundsperrerr	80
Hohlmeißel	124
Hohlmeißelzangen	102-105
Hohlsonden	50
HOSPITAL-PROVIDENCE Arterienklemmen	42
HOURIGAN Raspatorien	82

I

Interdentale Osteotome	92
Intraorale Retraktoren	68
Instrumente Beckenkamm	124-125
Instrumente Draht	112-114
Instrumente Gaumenspalten	115-117
Instrumente Lippen	115-117

J

JAEGER Lidplatte	74
JANSEN ZAUFAL Hohlmeißelzange	105
Jochbogenelevatorium	88
JOSEPH Feine Präparierscheren	24
JOSEPH Feine Wundhaken	54

K

Kabelanschluss	35
KAHRE Raspatorium	115
KAHRE-WILLIGER Raspatorien	83
Kanülen Kopf	46
Kanülen Saug	46-47
Keilosteotome	93
KELLY Arterienklemmen	42
KELLY Feine Präparierscheren	24
KILNER-DOUGHTY Zungendrucker	77, 117
KILNER-RAGNELL Feine Präparierscheren	23
Kinnhalter	63
Klemmen Adaptierung	97
Klemmen Arterien	41-42
Klemmen Bulldog	41
Klemmen Drahtdreh	113



Klemmen Drahtösen	113
Klemmen Präparier	43
Klemmen Ramus	65
Klemmen Tuch	43-44
Klingenhaltepinzetten	129
KLUBA Orbitahaken	73
KLUBA Spekulum	122
Knochendrähte	111
Knochenhaltezangen	100-101
Knochenmesszirkel	108
Knochenmühlen	127
Knochensplitterzangen	102
Knochenstopfer	107
Knochenspreizer	99
Knopfkanülen	46
KOCHER-LANGENBECK Wundhaken	62
KOCHER Wundhaken	59-60
KOFLER-HAJEK Stanze	107
KÖLN Mundsperrer	117
KÖNIG Raspatorium	84
Komprimierer	119
Kornzangen	45
KRETSCHMER Halterung	110
KRETSCHMER Referenz-Pin	110
KRETSCHMER Wundhaken	63
L	
LAMBOTTE MINI Osteotome	91
LAMBOTTE Osteotome	92
LANGENBECK Elevatorien	88
LANGENBECK-KOCHER Wundhaken	62
LANGENBECK-PARKER (US ARMY) Wundhaken	69
LANGENBECK Wundhaken	59
Lidfasspinzette	32
Lidhalter	73
Lidplatte	74
LINDEMANN Fräser	131
Lineal Röntgen	108
Lineal Stahl	108
Lippenhalter	71-72
Lippeninstrumente	115
LISTON RUSKIN Knochensplitterzangen	102
LOCKLIN Zahnfleischscheren	21
Löffel Beckenkamm	124
Löffel scharf	89
LUCAE Feine Wundhaken	56
LUER Hohlmeißelzangen	103
LUNIATSCHEK Tamponstopfer	112
M	
MACDONALD Elevatorium	87
MAIER Kornzangen	45

MARCHAC Knochenspreizer	99
Markierungsinstrumente	110
MARQUARDT Hohlmeißelzange	102
MATHIEU HM Nadelhalter	38-39
Maxilla-Mobilisator	96
MAYO-HEGAR HM Nadelhalter	37
MAYO Präparierscheren	26
MAYO-STILLE Präparierscheren	26
MCINDOE Anatomische Pinzette	28
MCINDOE Knochensplitterzangen	102
MCINDOE Raspatorien	116
MCKESSON Mundkeile	79
MEAD Hammer	90
MEAD Hohlmeißelzangen	103
MEDICON COTTLE Osteotome	91
Meißel Blutstillung	107
Meißel flach	91-92
MERSHON Drahtpositionierer	112
Messinstrumente	108-109
Messzirkel	109
METZENBAUM-BABY Feine Präparierscheren	24
METZENBAUM-SLIM Präparierscheren	25
MICRO 2000 Nadelhalter	40
MICRO 2000 Pinzetten	32
MICRO-ADSON Anatomische Pinzette	29
MICRO-SLIM HM Nadelhalter	39
MIDDELDORPF Wundhaken	61
Mikromotoren-System	130
Mikro Nadelhalter	40
Mikro Pinzetten	32
Mikro-Sägen	134-139
Mikro-Sagittal-Säge	135
Mikro-Stichsäge	137
MILLER SENN Feine Wundhaken	54
MINI-LAMBOTTE Osteotome	91
MINI RUSKIN Hohlmeißelzangen	105
Mobilisator	96
Mobilisierhaken	98
Mod. USA Öhrsonden	48
MOLT Raspatorium	82
MÖLTGEN Winkelmesser	108
MORITZ-SCHMIDT Zungendrucker	76
MOSQUITO BABY HARTMANN Arterienklemmen	41
MOSQUITO-HALSTED Arterienklemme	42
Mucosa-Spanner	129
Mucotom	129
Mundkeile	79
Mundsperrer	79-80, 117
Myrtenblattsonden	48
N	
Nadelhalter	36-40

Nadelhalter Mikro	40
Nasenhaken	74
Nasenraspeln	122
Nasenseptum-Osteotome	96
Nasenzangen	106
NELATON Hohllsonden	50
Nervhäkchen	54

O	
OBWEGESER Ahlen	113
OBWEGESER Alveolar-Haken	64
OBWEGESER Beckenkamm-Reraktoren	125
OBWEGESER Blattosteotome	93
OBWEGESER Drahtösenklemme	113
OBWEGESER Fragment-Adaptierungsklemmen	97
OBWEGESER-FREER Elevatorium	87
OBWEGESER-FREER Raspatorien	82
OBWEGESER HM Drahtdrehklemme	113
OBWEGESER Interdentale Osteotome	92
OBWEGESER Keilosteotome	93
OBWEGESER Kinnhalter	63
OBWEGESER Knochenspreizer	99
OBWEGESER Maxilla-Mobilisator	96
OBWEGESER Nasenseptum-Osteotome	96
OBWEGESER Osteotome	92-94
OBWEGESER Progenie-Rinnen	63
OBWEGESER Ramus-Haken	66
OBWEGESER Ramus-Keil-Osteotome	93
OBWEGESER Ramus-Klemmen	65
OBWEGESER Raspatorien	84-86
OBWEGESER Spaltosteotome	93
OBWEGESER Spina-nasalis-Haken	65
OBWEGESER Tuber-Osteotome	93
OBWEGESER Unterkieferrand-Haken	64
OBWEGESER Weichteilhaken	67
Öhrsonden	48
Orbitahaken	73
Osseoskalpell	136
Osteotome	91-96
Osteotome Blatt	93
Osteotome interdental	92
Osteotome Keil	93
Osteotome Spalt	93-94
Osteotome Tuber	93
Osteotome Zylinder	126
Oszillierende Mikro-Säge	134

P	
PARKER-LANGENBECK (US ARMY)Wundhaken	69
PARKER Wundhaken	69
PARTSCH Flachmeißel	91

PASSOW Blutstillungsmeißel	107
Pinzetten anatomisch	27-30
Pinzetten antihaft	33-34
Pinzetten bajonett	29
Pinzetten bipolar	33-34
Pinzetten chirurgisch	29-31
Pinzetten Gewebefass	32
Pinzetten Mikro	32
Positionierer	99
POTTS-SMITH HM Anatomische Pinzetten	28
Präparierklemmen	43
Präparierscheren	24-26
Progenie-Rinnen	63
PROVIDENCE-HOSPITAL Arterienklemmen	42

R	
RAGNELL (KILNER) Feine Präparierscheren	23
Ramus-Haken	66
Ramus-Klemmen	65
Raspatorien	82-86, 115
Raspatorium Fibula	128
Raspeln Nase	123
Referenz-Pin	110
Repositionszangen	98
Retraktor Unterkieferrand	64
Retraktoren Beckenkamm	125
Retraktoren extraoral	68
Retraktoren intraoral	68
ROEDER BACKHAUS Tuchklemme	44
Röntgen-Messstab	108
ROUX Wundhaken	70
ROWE Repositionszangen	98
RUSKIN Hohlmeißelzangen	104-105
RUSKIN-LISTON Knochensplitterzangen	102
RUSKIN-MINI Hohlmeißelzangen	105

S	
SACHSE Mikro-Sagittal-Säge	135
SACHSE Osseoskalpell	136
SACHSE Oszillierende Mikro-Säge	134
Sägeblätter	134-137
Saugelevatorium	47
Sauginstrumente	46-47
Saugkanülen	46-47
Scharfe Löffel	89
SCHEER FREER Elevatorium	115
Scheren chirurgische	22-23
Scheren Draht	114
Scheren Fein	20
Scheren Präparier	24-26
Scheren Präparier fein	20, 23-24
Scheren Tonsillen	21



Scheren Zahnfleisch	21
SCHMIDT MORITZ Zungendrucker	76
Schraub-Einsätze	133
SEMB Knochenhaltezange	101
SENN-MILLER Feine Wundhaken	54
Servotronic	130
SHEPARD Kortikalisstanze	126
SHEPARD Zylinder-Osteotome	126
Siebbeinzangen	106
SILVER Osteotome	95
Sinuslifting-Elevatorien	118-119
Skalpelle	14-16
Skalpellgriffe	14-15
Skalpellgriffe Mini	16
Skalpellklingen	14-15
Skalpellklingen Mini	16
SLIM METZENBAUM Präparierscheren	25
SLIM MICRO HM Nadelhalter	39
SMITH Knochenspreizer	99
SMITH POTTS HM Anatomische Pinzetten	28
Sonden hohl	50
Sonden Ohr	48
Sonden Myrtenblatt	48
Sonden Tränenkanal	49
Spaltosteotome	93-94
Spatel Zunge	75, 79
Spekulum	122
Sperrer Mund	79-80, 117
Spina-nasalis-Haken	65
Spreizer Knochen	99
Spreizer Wund	74
Stahllineale	108
Stanze	107
STEINHÄUSER Knochenhaltezangen	100
STEINHÄUSER Mucosa-Spanner	129
STEINHÄUSER Mucotome	129
STELLBRINK Hohlmeißelzangen	104
STERNBERG Lippen- und Wangenhalter	71
STILLE MAYO Präparierscheren	26
STILLER Komprimierer	119
STILLER Raspatorium	82
STILLER Saugkanüle	46
STILLER Sinuslifting-Elevatorien	118-119
T	
Tamponstopfer	112
TAYLOR-CUSHING Bajonettpinzette	29
TESSIER Mobilisierhaken	98
TESSIER Osteotome	94
TOBOLD Zungendrucker	76
TOENNIS-ADSON Präparierscheren	24
Tonsillenschere	21

Tränenkanalsonden	49
Trepäne	124
Tuber-Osteotome	93
Tuchklemmen	43-44
U	
UNIV. MINNESOTA CAWOOD Lippen- und Wangenhalter	72
UNIVERSAL HM Drahtschere	114
Unterkiefferrand-Retraktor	64
US-ARMY Wundhaken	69
V	
Venenhaken	54-55
Vestibulumhaken	71
VOLKMANN Scharfe Löffel	89
VOLKMANN Wundhaken	58, 60
W	
WAGNER Feine Scheren	20
WALTER Lidfasspinzette	32
WANG Raspatorien	116
Wangenhalter	71-72
WANGERIN Positionierer	99
WASSMUND Wundhaken	61
Watteträger	50
Weichteilhaken	67
WEIL-BLAKESLEY Siebbeinzangen	106
WEITLANER-WULLSTEIN Wundspreizer	74
WIEDER Zungendrucker	76
WILLIAMS BOWMAN Tränenkanalsonden	49
WILLIGER KAHRE Raspatorien	83
WILLIGER Raspatorien	85
Winkelmesser	108
Winkelschraubendreher	132-133
WOOD CRILE HM Nadelhalter	38
WOOD CRILE Nadelhalter	37
WULLSTEIN-WEITLANER Wundspreizer	74
Wundhaken	54-64
Wundhaken doppelendig	69-70
Wundhaken fein	54-57
Wundspreizer	74
Y	
YOUNG Zungenzange	78
Z	
Zahnfleischscheren	21
Zangen Drahtschneide	114
Zangen Flach	112
Zangen Hohlmeißel	102-105
Zangen Knochenhalte	100-101

Zangen Knochensplitter	102
Zangen Korn	45
Zangen Reposition	98
Zangen Siebbein	106
Zangen Zunge	78
ZAUFAL-JANSEN Hohlmeißelzange	105
Zirkel	108-109
Zungendrücker	76-79, 117
Zungenspatel	75, 80
Zungenzangen	78
Zylinder-Osteotome	126



A	
Adapting forceps	97
ADSON-BABY Dissecting forceps	43
ADSON Dressing forceps	28
ADSON Elevators	88
ADSON HM Dressing forceps	28
ADSON MICRO Dressing forceps	29
ADSON Raspatories	83
ADSON TOENNIS Dissecting scissors	24
Alveolar retractor	64
Angular screwdrivers	132-133
Arch bars	111
AUFRIEHT GUBISCH Nasal retractor	74
AUFRIEHT Nasal retractor	74
Awls	113
B	
BABY ADSON Dissecting forceps	43
BABY-CRILE-WOOD HM Needle holders	37
BABY-METZENBAUM Delicate dissecting scissors	24
BABY-MOSQUITO-HARTMANN Hemostatic forceps	41
BACKHAUS-ROEDER Towel clamp	44
BACKHAUS Towel clamps	43-44
BARSKY Skin hooks	56
Bayonet forceps	29
BENICKE Delicate retractors	55
BENNET Elevators	87
BEUSE Delicate dissecting scissors	23
BEYER Bone rongeurs	103-104
Bipolar connecting cables	35
Bipolar non-sticking forceps	33-34
Blade holding forceps	129
Blade osteotomes	93
BLAKE Scalpel handle	14
BLAKESLEY WEIL Ethmoid bone forceps	106
BLOCKSMA Hooks	115
BLUME Osteotome	95
BLUMENTHAL Bone rongeurs	103
Bone cutting forceps	102
Bone holding forceps	100-101
Bone measuring dividers	108
Bone mills	127
Bone rongeurs	102-105
Bone separators	99
Bone suturing wires	111
Bone tampers	107
BOWMAN Lacrimal probes	49
BOWMAN (WILLIAMS) Lacrimal probes	49
Bracket	35
BROWN Tissue grasping forceps	32

BRUENINGS Chisels	92
BRUENINGS Tongue spatula	75
BUCHWALD Tongue spatula	75
Bulldog clamps	41
Burr rack	124
Burrs	131
C	
Cables connecting	35
Calipers	109
Cannulas suction	46-47
Cannulas with olive	46
CASTROVIEJO Calipers	109
CASTROVIEJO-EPKER Calipers	109
CAWOOD Lip and cheek retractor	72
Channel retractors	63
Cheek retractors	71-72
Chin retractor	63
Chisels	91-92
Chisels hemostatic	107
CINELLI Osteotomes	95
Clamps Bulldog	41
Clamps ramus	65
Clamps towel	43-44
CLAUDINHA Tongue spatulas	80
Cleft palate instruments	115-117
Cleft palate raspator	115
COLLIN Retractor	69
COLLIN Tongue seizing forceps	78
Compressor	119
Connecting cables	35
COTTLE Osteotomes	94
COTTLE-MEDICON Osteotomes	91
Cotton carriers	50
CRILE-WOOD BABY HM Needle holder	37
CRILE-WOOD HM Needle holders	38
CRILE-WOOD Needle holders	37
Curettes iliac crest	124
Curettes sharp	89
CUSHING Dressing forceps	30
CUSHING HM Dressing forceps	30
CUSHING Nerve hooks	54
CUSHING (TAYLOR) Bayonet forceps	29
CUSHING Tissue forceps	30
CUSHING Vein retractors	54-55
Cylinder osteotomes	126
D	
DANDY Hemostatic forceps	41
DAUBENSPECK Sharp curettes	89
DAUTREY Arch bars	111
DEAN Tonsil scissors	21

DEBAKEY HM Needle holders	38
Delicate dissecting scissors	20, 23-24
Delicate retractors	54-58
Delicate scissors	20
DENHART-HOEFERT Mouth gag	80
DENHART Mouth gag	80
DESMARRES Lid retractors	73
DIEFFENBACH Bulldog clamps	41
DINGMAN Bone holding forceps	101
DINGMAN Mouth gag	79
DINGMAN Raspatory	82
DINGMAN Tongue depressors	77, 117
DINGMAN Zygoma elevator	88
Directors	50
Dissecting forceps	43
Dissecting scissors	24-26
DOCKHORN Cheek retractors	72
DOUGHTY KILNER Tongue depressors	77, 117
DOYEN Tongue spatulas	75
Dressing forceps	27-30, 45
E	
Elevator zygoma	88
Elevators	87-88, 115
EPKER CASTROVIEJO Calipers	109
ERICH Arch bars	111
Ethmoid bone forceps	106
Extra oral retractors	68
F	
FERGUSON-FRAZIER Suction cannulas	47
Fibula raspatory	128
Flat nose pliers	112
Flexometer	108
Forceps adapting	97
Forceps bayonet	29
Forceps bipolar	33-34
Forceps bone cutting	102
Forceps bone holding	100-101
Forceps dissecting	43
Forceps dressing	27-31, 45
Forceps ethmoid bone	106
Forceps hemostatic	41-42
Forceps Micro	32
Forceps non-sticking	33-34
Forceps reposition	98
Forceps tissue	29-31
Forceps tissue grasping	32
Forceps tongue seizing	78
Forceps wire loop	113
FOX Gum scissors	21
Fragment adapting forceps	97

FRAZIER (FERGUSON) Suction cannulas	47
FRAZIER Skin hook	56
FRAZIER Suction cannulas	47
FREER Elevators	87
FREER OBWEGESER Elevator	87
FREER-OBWEGESER Raspatories	82
FREER Raspatory	86
FREER-SCHEER Elevator	115
FROHN Cotton carriers	50
G	
Gags mouth	79-80, 117
GERALD Dressing forceps	30
GILLIES Delicate retractors	56
GILLIES Elevator	88
GILLIES HM Needle holder	38
GILLIES Tissue forceps	31
Gouges	124
GROSS Dressing forceps	45
GUBISCH-AUFRICHT Nasal retractor	74
Gum scissors	21
GUTHRIE Delicate retractors	56
H	
HAJEK Mallet	90
HAJEK-KOFLER Rongeurs	107
HAKIM Fibula raspatory	128
HALSTED-MOSQUITO Hemostatic forceps	42
Hand pieces	131
HANNA Tongue spatula	80
HARALDSSON Suction elevators	47
HARTMANN (BABY-MOSQUITO) Hemostatic forceps	41
HARTMANN Tongue depressor	78
HEGAR MAYO HM Needle holders	37
Hemostatic chisels	107
Hemostatic forceps	41-42
HM Rasp	137
HM Wire cutting pliers	114
HOEFERT DENHART Mouth gag	80
Hooks nerve	54
Hooks orbital	73
Hooks skin	56
HOSPITAL PROVIDENCE Hemostatic forceps	42
HOURIGAN Raspatories	82
I	
Instruments cleft palate	115-117
Instruments lip	115-117
Instruments pelvic crest	124-125
Instruments wire	112-114
Interdental osteotomes	92



Intra oral retractors	68
J	
JAEGER Lid plate	74
JANSEN ZAUFAL Bone rongeur	105
JOSEPH Delicate dissecting scissors	24
JOSEPH Delicate retractors	54
K	
KAHRE Raspatory	115
KAHRE-WILLIGER Raspatories	83
KELLY Delicate dissecting scissors	24
KELLY Hemostatic forceps	42
KILNER-DOUGHTY Tongue depressors	77, 117
KILNER RAGNELL Delicate dissecting scissors	23
KLUBA Orbital hooks	73
KLUBA Speculum	122
KOCHER-LANGENBECK Retractors	62
KOCHER Retractors	59-60
KOELN Mouth gag	117
KOENIG Raspatory	84
KOFLER HAJEK Rongeur	107
KRETSCHMER Holder	110
KRETSCHMER Reference pin	110
KRETSCHMER Retractor	63
L	
Lacrimal probes	49
LAMBOTTE MINI Osteotomes	91
LAMBOTTE Osteotomes	92
LANGENBECK Elevators	88
LANGENBECK-KOCHER Retractors	62
LANGENBECK PARKER (US ARMY) Retractor	69
LANGENBECK Retractors	59
Lid grasping forceps	32
Lid plate	74
Lid retractors	73
LINDEMANN Burrs	131
Lip instruments	115-117
Lip retractors	71-72
LISTON RUSKIN Bone cutting forceps	102
LOCKLIN Gum scissors	21
LUCAE Delicate retractors	56
LUER Bone rongeurs	103
LUNIATSCHEK Gauze packer	112
M	
MACDONALD Elevators	87
MAIER Dressing forceps	45
Mallets	90
Mandibular rim retractor	64
MARCHAC Bone separators	99

Marking instruments	110
MARQUARDT Bone rongeurs	102
MATHIEU HM Needle holders	38-39
Maxilla mobilizer	96
MAYO Dissecting scissors	24
MAYO-HEGAR HM Needle holders	37
MAYO-STILLE Dissecting scissors	26
MCINDOE Bone cutting forceps	102
MCINDOE Dressing forceps	28
MCINDOE Raspatories	116
MCKESSON Mouth gags	80
MEAD Bone rongeurs	103
MEAD Mallets	90
Measuring instruments	108-109
MEDICON-COTTLE Osteotomes	91
MERSHON Wire pusher	112
METZENBAUM-BABY Delicate dissecting scissors	24
METZENBAUM-SLIM Dissecting scissors	25
MICRO 2000 Forceps	32
MICRO 2000 Needle holders	40
Micro compass saw	137
Micro forceps	32
Micro motor system	130
Micro needle holders	40
Micro oscillating saw	134
Micro sagittal saw	135
Micro saws	134-139
MICRO-ADSON Dressing forceps	29
MICRO-SLIM HM Needle holders	39
MIDDELDORPF Retractors	61
MILLER-SENN Delicate retractors	54
MINI-LAMBOTTE Osteotomes	91
MINI-RUSKIN Bone rongeurs	105
Mixing cup	124
Mobilizer	96
Mobilizing retractors	98
MOD. USA Probes with eye	48
MOELTGEN Flexometer	108
MOLT Raspatory	82
MORITZ-SCHMIDT Tongue depressors	76
MOSQUITO-BABY-HARTMANN Hemostatic forceps	41
MOSQUITO-HALSTED Hemostatic forceps	42
Mouth gags	79-80, 117
Mucosa stretcher	129
Mucotome	129
Myrtle leaf probes	48
N	
Nasal forceps	106
Nasal rasps	123

Nasal retractors	74
Nasal septum osteotomes	96
Nasal spine retractor	65
Needle holders	36-40
Needle holders Micro	40
NELATON Directors	50
Nerve hooks	54
Non-sticking bipolar forceps	33-34

O

OBWEGESER Alveolar retractor	64
OBWEGESER Awls	113
OBWEGESER Blade osteotomes	93
OBWEGESER Bone separator	99
OBWEGESER Channel retractors	63
OBWEGESER Chin retractor	63
OBWEGESER Fragment adapting forceps	97
OBWEGESER-FREER Elevators	87
OBWEGESER-FREER Raspatories	82
OBWEGESER HM Wire twister	113
OBWEGESER Iliac crest retractors	125
OBWEGESER Interdental osteotomes	92
OBWEGESER Mandibular rim retractor	64
OBWEGESER Maxilla mobilizer	96
OBWEGESER Nasal septum osteotomes	96
OBWEGESER Nasal spine retractors	65
OBWEGESER Osteotomes	92-94
OBWEGESER Pterygoid osteotomes	93
OBWEGESER Ramus clamps	65
OBWEGESER Ramus retractors	66
OBWEGESER Ramus wedge osteotomes	93
OBWEGESER Raspatories	84-86
OBWEGESER Soft tissue retractors	67
OBWEGESER Splitting osteotomes	93
OBWEGESER Wedge osteotomes	93
OBWEGESER Wire loop forceps	113
Operating scissors	22-23
Orbital hooks	73
Osseoscalpel	136
Osteotomes	91-96
Osteotomes blade	93
Osteotomes cylinder	126
Osteotomes interdental	92
Osteotomes pterygoid	93
Osteotomes splitting	93-94
Osteotomes wedge	93

P

PARKER-LANGENBECK (US ARMY) Retractor	69
PARKER Retractors	69
PARTSCH Chisels	91
PASSOW Hemostatic chisels	107

Pelvic crest instruments	124-125
Pliers flat nose	112
Pliers wire cutting	114
Positioner	99
POTTS-SMITH HM Dressing forceps	28
Probes lacrimal	49
Probes myrtle leaf	48
Probes with eye	48
PROVIDENCE-HOSPITAL Hemostatic forceps	42
Pterygoid osteotomes	93

R

RAGNELL (KILNER) Delicate dissecting scissors	23
Ramus clamps	65
Ramus retractors	66
Raspatories	82-86, 115
Raspatory fibula	128
Rasps nasal	123
Reference pin	110
Reposition forceps	98
Retractors mandibular rim	64
Retractors	54-64
Retractors cheek	71-72
Retractors delicate	54-57
Retractors double-ended	69-70
Retractors extra oral	68
Retractors iliac crest	125
Retractors intra oral	68
Retractors lid	73
Retractors lip	71-72
Retractors mobilizing	98
Retractors nasal	74
Retractors nasal spine	65
Retractors ramus	66
Retractors self-retaining	74
Retractor soft tissue	67
Retractors vein	54-55
ROEDER-BACKHAUS Towel clamps	44
Rongeur	107
Rongeurs bone	102-105
ROUX Retractors	70
ROWE Reposition forceps	98
Rulers	108
RUSKIN Bone rongeurs	104-105
RUSKIN-LISTON Bone cutting forceps	102
RUSKIN-MINI Bone rongeurs	105
S	
SACHSE Micro oscillating saw	134
SACHSE Micro sagittal saw	135
SACHSE Osseoscalpel	136



Saw blades	134-137
Scalpel blades	14-15
Scalpel blades mini	16
Scalpel handles	14-15
Scalpel handles mini	16
Scalpels	14-16
SCHEER FREER Elevator	115
SCHMIDT MORITZ Tongue depressor	76
Scissors delicate	20
Scissors dissecting	24-26
Scissors dissecting delicate	20, 23-24
Scissors gum	21
Scissors operating	22-23
Scissors tonsil	21
Scissors wire cutting	114
Screwing inserts	133
Self-retaining retractors	74
SEMB Bone holding forceps	101
SENN-MILLER Delicate retractors	54
Separators bone	99
Servotronic	130
Sharp curettes	89
SHEPARD Cortex cutter	126
SHEPARD Cylinder osteotomes	126
SILVER Osteotomes	95
Sinuslifting elevators	118-119
Skin hooks	56
SLIM METZENBAUM Dissecting scissors	25
SLIM MICRO HM Needle holders	39
SMITH Bone separators	99
SMITH POTTS HM Dressing forceps	28
Soft tissue retractors	67
Spatulas tongue	75, 79
Speculum	122
Splitting osteotomes	93-94
STEINHAEUSER Bone holding forceps	100
STEINHAEUSER Mucosa stretcher	129
STEINHAEUSER Mucotome	129
STELLBRINK Bone rongeurs	104
STERNBERG Lip and cheek retractor	71
STILLE MAYO Dissecting scissors	26
STILLER Compressor	119
STILLER Raspatory	82
STILLER Sinuslifting elevators	118-119
STILLER Suction cannula	46
Suction cannula	46-47
Suction elevator	47
Suction instruments	46-47
Surgical hand pieces	131
T	
TAYLOR-CUSHING Bayonet forceps	29

TESSIER Mobilizing retractors	98
TESSIER Osteotomes	94
Tissue forceps	29-31
Tissue grasping forceps	32
TOBOLD Tongue depressor	76
TOENNIS-ADSON Dissecting scissors	24
Tongue depressors	76-79, 117
Tongue seizing forceps	78
Tongue spatulas	75, 80
Tonsil scissors	21
Towel clamps	43-44
Trephines	124
Tungsten carbide rasp	137
Twister wire	113
U	
UNIV. MINNESOTA CAWOOD Lip and cheek retractor	72
UNIVERSAL HM Wire Cutting Scissors	114
US-ARMY Retractor	69
V	
Vein retractors	54-55
Vestibule retractors	71
VOLKMANN Retractors	58, 60
VOLKMANN Sharp curettes	89
W	
WAGNER Delicate scissors	20
WALTER Lid grasping forceps	32
WANG Raspatories	116
WANGERIN Positioner	99
WASSMUND Retractor	61
Wedge osteotomes	93
WEIL-BLAKESLEY Ethmoid bone forceps	106
WEITLANER-WULLSTEIN Self-retaining retractors	74
WIEDER Tongue depressors	76
WILLIAMS BOWMAN Lacrimal probe	49
WILLIGER KAHRE Raspatories	83
WILLIGER Raspatories	85
Wire cutting pliers	114
Wire cutting scissors	114
Wires	111
Wire instruments	112-114
Wire loop forceps	113
Wire pusher	112
Wire twister	113
WOOD CRILE HM Needle holders	38
WOOD CRILE Needle holders	37
WULLSTEIN WEITLANER Self-retaining retractors	74

X	
X-Ray ruler	108
Y	
YOUNG Tongue seizing forceps	78
Z	
ZAUFAL-JANSEN Bone rongeur	105
Zygoma elevator	88



A	
Abrebocas	79-80, 117
ADSON-BABY Pinzas para disección	43
ADSON Elevador	88
ADSON HM Pinza anatómica	28
ADSON Legras	83
ADSON MICRO Pinzas anatómicas	29
ADSON Pinza anatómica	28
ADSON TOENNIS Tijeras para disección	24
Alambre para huesos	111
Alicate plano	112
Arcos de alambre	111
AUFRIEHT GUBISCH Separador nasale	74
AUFRIEHT Separador nasale	74
B	
BABY ADSON Pinzas para disección	43
BABY-CRILE-WOOD HM Porta-aguja	37
BABY-METZENBAUM Tijeras finas para disección	24
BABY-MOSQUITO-HARTMANN Pinzas hemostáticas	41
BACKHAUS Pinzas de campo	43-44
BACKHAUS-ROEDER Pinza de campo	44
Bajalenguas	76-79, 117
BARSKY Ganchitos para piel	56
BENICKE Separadores finos	55
BENNET Elevador	87
BEUSE Tijeras finas para disección	23
BEYER Pinzas gubias	103-104
Bisturíes	14-16
BLAKE Mango de bisturí	14
BLAKESLEY WEIL Pinzas para hueso etmoides	106
BLOCKSMA Ganchitos	115
BLUME Osteótomo	95
BLUMENTHAL Pinzas gubias	103
BOWMAN Sondas exploradoras para canal lagrimal	49
BOWMAN (WILLIAMS) Sondas exploradoras para canal lagrimal	49
BROWN Pinzas para agarrar tejidos	32
BRUENINGS Cinceles	92
BRUENINGS Espátula bucal	75
BUCHWALD Espátula bucal	75
Bulldog clamps	41
C	
Caballete para broca	124
Cables de conexión	35
Cánulas aspiración	46-47
Cánulas con oliva	46
CASTROVIEJO Compás	109

CASTROVIEJO-EPKER Compás	109
CAWOOD Separador de labios y mejillas	72
Cinceles	91-92
Cinceles para hemostasia	107
Cinceles tamponadores para huesos	107
CINELLI Osteótomos	95
Clamps Bulldog	41
Clamps para el ramo	65
CLAUDINHA Espátula bucale	80
COLLIN Pinza tiralengua	78
COLLIN Separador	69
Compás	108-109
Compás para hueso	108
Compresor	119
COTTLE-MEDICON Osteótomos	91
COTTLE Osteótomos	94
CRILE-WOOD BABY HM Porta-aguja	37
CRILE-WOOD HM Porta-agujas	38
CRILE-WOOD Porta-agujas	37
Cucharillas cortantes	89
Cucharilla para la cresta ilíaca	124
CUSHING Ganchitos para nervios	54
CUSHING Ganchos para venas	54-55
CUSHING HM Pinzas anatómicas	30
CUSHING Pinzas anatómicas	30
CUSHING Pinzas quirúrgicas	30
CUSHING (TAYLOR) Pinza en forma bayoneta	29
D	
DANDY Pinzas hemostáticas	41
DAUBENSPECK Cucharillas cortantes	89
DAUTREY Arcos de alambre	111
DEAN Tijera para amígdalas	21
DEBAKEY HM Porta-agujas	38
DENHART Abreboca	80
DENHART-HOEFERT Abreboca	80
DESMARRES Separadores para párpados	73
Destornilladores de ángulo	132-133
DIEFFENBACH Clamps Bulldog	41
DINGMAN Abrebocas	79
DINGMAN Bajalenguas	77, 117
DINGMAN Elevador zigomatico	88
DINGMAN Legra	82
DINGMAN Pinzas prensoras de huesos	101
Dispositivo	35
DOCKHORN Separadores de mejillas	72
DOUGHTY-KILNER Bajalenguas	77, 117
DOYEN Espátulas bucales	75
E	
Elevador aspirador	47
Elevador zigomatico	88

Elevadores	87-88, 115
Elevadores para sinus-lift	118-119
EPKER-CASTROVIEJO Compás	109
ERICH Arcos de alambre	111
Escofina de carburo de tungsteno	137
Espátulas bucales	75, 80
Espéculo	122
Estiletes con ojete	48
Estiletes hoja de mirto	48

F

FERGUSON-FRAZIER Cánulas aspiración	47
Fibula legra	128
FOX Tijeras para encías	21
FRAZIER Cánulas aspiración	47
FRAZIER (FERGUSON) Cánulas aspiración	47
FRAZIER Ganchito para piel	56
FREER Elevadores	87
FREER Legra	86
FREER OBWEGESER Elevador	87
FREER-OBWEGESER Legras	82
FREER-SCHEER Elevador	115
Fresas	131
FROHN Porta-algodones	50

G

Ganchitos para nervios	54
Ganchitos para piel	56
Gancho de mentón	63
Ganchos para venas	54-55
GERALD Pinzas anatómicas	30
GILLIES Elevador	88
GILLIES HM Porta-aguja	38
GILLIES Pinza quirúrgica	31
GILLIES Separadores finos	56
Goniómetro	108
GROSS Pinzas para curaciones	45
Gubia	124
GUBISCH-AUFRICHT Separador nasale	74
GUTHRIE Separadores finos	56

H

HAJEK-KOFLER Pinzas saca-bocadas	107
HAJEK Martillo	90
HAKIM Legra para fibula	128
HALSTED-MOSQUITO Pinzas hemostáticas	42
HANNA Espátula bucale	80
HARALDSSON Elevadores aspiradores	47
HARTMANN (BABY-MOSQUITO) Pinzas hemostáticas	41
HARTMANN Bajalengua	78
HEGAR-MAYO HM Porta-agujas	37

HM Escofina	137
HM Pinzas para cortar alambre	114
HOEFERT DENHART Abreboca	80
Hojas de bisturí	14-15
Hojas de bisturí mini	16
Hojas de sierra	134-137
HOSPITAL-PROVIDENCE Pinzas hemostáticas	42
HOURIGAN Legras	82

I

Insertos para destornillador	133
Instrumento para posicionar alambre	112
Instrumentos de aspiración	46-47
Instrumentos para alambre	112-114
Instrumentos para fisuras paladares	115-117
Instrumentos para la cresta ilíaca	124-125
Instrumentos para labios	115-117
Instrumentos para marcar	110
Instrumentos para medir	108-109

J

JAEGER Placa para párpados	74
JANSEN ZAUFAL Pinza gubia	105
JOSEPH Separadores finos	54
JOSEPH Tijeras finas para disección	24

K

KAHRE Legra	115
KAHRE-WILLIGER Legras	83
KELLY Pinzas hemostáticas	42
KELLY Tijeras finas para disección	24
KILNER-DOUGHTY Bajalenguas	77, 117
KILNER RAGNELL Tijeras finas para disección	23
KLUBA Espéculo	122
KLUBA Separadores orbitales	73
KOCHER LANGENBECK Separadores	62
KOCHER Separadores	59-60
KOELN Abreboca	117
KOENIG Legra	84
KOFLER-HAJEK Pinza saca-bocada	107
KRETSCHMER Perno de referencia	110
KRETSCHMER Separador	63
KRETSCHMER Soporte	110

L

LAMBOTTE-MINI Osteótomos	91
LAMBOTTE Osteótomos	92
LANGENBECK Elevadores	88
LANGENBECK-KOCHER Separadores	62
LANGENBECK-PARKER (US ARMY) Separadores	69
LANGENBECK Separadores	59



Legra para fibula	128
Legra para fisura palatina	115
Legras	82-86, 115
Leznas	113
LINDEMANN Fresas	131
LISTON-RUSKIN Pinzas cortantes para huesos	102
LOCKLIN Tijeras para encías	21
LUCAE Separadores finos	56
LUER Pinzas gubias	103
LUNIATSCHEK Tamponador	112

M

MACDONALD Elevador	87
MAIER Pinzas para curaciones	45
Mangos de bisturí	14-15
Mangos de bisturí mini	16
MARCHAC Separador de hueso	99
MARQUARDT Pinzas gubias	102
Martillos	90
MATHIEU HM Porta-agujas	38-39
MAYO-HEGAR HM Porta-agujas	37
MAYO-STILLE Tijeras para disección	26
MAYO Tijeras para disección	26
MCINDOE Legras	116
MCINDOE Pinza anatómica	28
MCINDOE Pinza cortante para hueso	102
MCKESSON Abrebocas	79
MEAD Martillo	90
MEAD Pinzas gubias	103
MEDICON COTTLE Osteótomos	91
MERSHON Instrumento para posicionar alambre	112
METZENBAUM-BABY Tijeras finas para disección	24
METZENBAUM-SLIM Tijeras para disección	25
MICRO 2000 Pinzas	32
MICRO 2000 Porta-agujas	40
MICRO-ADSON Pinzas anatómicas	29
Micro pinzas	32
Micro porta-agujas	40
Micro sierra de vaivén	137
Micro sierra oscilante	134
Micro sierra sagital	135
Micro sierras	134-139
MICRO-SLIM HM Porta-agujas	39
MIDDELDORPF Separadores	61
MINI-LAMBOTTE Osteótomos	91
MILLER SENN Separadores finos	54
MINI RUSKIN Pinzas gubias	105
MOD. USA Estiletos con ojete	48
MOELTGEN Goniómetro	108
Molinos de hueso	127

MOLT Legra	82
MORITZ-SCHMIDT Bajalengua	76
MOSQUITO BABY HARTMANN Pinzas hemostáticas	41
MOSQUITO HALSTED Pinzas hemostáticas	42
Movilizador maxilar	96
Mucotomo	129

N

NELATON Sondas acanaladas	50
Non-stick pinzas bipolares no adherentes	33-34

O

OBWEGESER Clamps ramus	65
OBWEGESER-FREER Elevador	87
OBWEGESER-FREER Legras	82
OBWEGESER Gancho de mentón	63
OBWEGESER HM Pinza para torcer alambre	113
OBWEGESER Legras	84-86
OBWEGESER Leznas	113
OBWEGESER Movilizador maxilar	96
OBWEGESER Osteótomos	92-94
OBWEGESER Osteótomos de cuña	93
OBWEGESER Osteótomos de hoja	93
OBWEGESER Osteótomos hendedores	93-94
OBWEGESER Osteótomos interdetales	92
OBWEGESER Osteótomos para el ramo	93
OBWEGESER Osteótomos para el tabique nasal	96
OBWEGESER Osteótomos pterigoideo	93
OBWEGESER Pinza para ojete de alambre	113
OBWEGESER Pinzas adaptadoras para fragmentos	97
OBWEGESER Separador alveolar	64
OBWEGESER Separador para el borde del maxilar inferior	64
OBWEGESER Separadores de hueso	99
OBWEGESER Separadores mandibulares	63
OBWEGESER Separadores para cresta ilíaca	125
OBWEGESER Separadores para el ramo	66
OBWEGESER Separadores para espina nasal	65
OBWEGESER Separadores para partes blandas	67
Osseoscalpel	136
Osteótomos	91-96
Osteótomos cilíndricos	126
Osteótomos de cuña	93
Osteótomos de hoja	93
Osteótomos hendedores	93-94
Osteótomos interdetales	92
Osteotomos para el tabique nasal	96
Osteótomos pterigoideo	93

P	
PARKER-LANGENBECK (US ARMY) Separadores	69
PARKER Separadores	69
PARTSCH Cinceles	91
PASSOW Cinceles para hemostasia	107
Perno de referencia	110
Piezas de mano quirúrgicas	131
Pinza en forma bayoneta	29
Pinza para ojetes de alambre	113
Pinza para torcer alambre	113
Pinzas adaptadoras	97
Pinzas anatómicas	27-30
Pinzas bipolares no adherentes	33-34
Pinzas cortantes para huesos	102
Pinzas de campo	43-44
Pinzas gubias	102-105
Pinzas hemostáticas	41-42
Pinzas micro	32
Pinzas nasales	106
Pinzas para agarrar párpados	32
Pinzas para agarrar tejidos	32
Pinzas para cortar alambre	114
Pinzas para curaciones	45
Pinzas para disección	43
Pinzas para hueso etmoides	106
Pinzas para reposicionar	98
Pinzas porta-hojas	129
Pinzas prensoras de huesos	100-101
Pinzas quirúrgicas	29-31
Pinzas saca-bocadas	107
Pinzas tiralengua	78
Pisón para huesos	107
Placa para párpados	74
Porta-agujas	36-40
Porta-agujas micro	40
Porta-algodones	50
Posicionador	99
POTTS-SMITH HM Pinzas anatómicas	28
PROVIDENCE-HOSPITAL Pinzas hemostáticas	42
R	
RAGNELL (KILNER) Tijeras finas para disección	23
Raspadores nasales	123
Regla radiografica	108
Reglas	108
ROEDER BACKHAUS Pinza de campo	44
ROUX Separadores	70
ROWE Pinzas para reposicionar	98
RUSKIN Pinzas gubias	104-105
RUSKIN-LISTON Pinzas cortantes para huesos	102
RUSKIN-MINI Pinzas gubias	105

S	
SACHSE Micro sierra oscilante	134
SACHSE Micro sierra sagital	135
SACHSE Osseoscalpel	136
SCHEER FREER Elevador	115
SCHMIDT MORITZ Bajalengua	76
SEMB Pinza prensora de hueso	101
SENN-MILLER Separadores finos	54
Separador alveolar	64
Separador para el borde del maxilar inferior	64
Separadores	54-64
Separadores autoestáticos	74
Separadores de hueso	99
Separadores de labios y mejillas	71-72
Separadores de movilización	98
Separadores dobles	69-70
Separadores extra orales	68
Separadores finos	54-58
Separadores intra orales	68
Separadores mandibulares	63
Separadores nasales	74
Separadores orbitales	73
Separadores para cresta ilíaca	125
Separadores para el ramo	66
Separadores para espina nasal	65
Separadores para párpados	73
Separadores para partes blandas	67
Separadores vestibulares	71
Servotronic	130
SHEPARD Osteótomos cilíndricos	126
SHEPARD Punzonadoras cortical	126
SILVER Osteótomos	95
Sistema de micromotor	130
SLIM METZENBAUM Tijeras para disección	25
SLIM MICRO HM Porta-agujas	39
SMITH POTTS HM Pinzas anatómicas	28
SMITH Separador de hueso	99
Sondas acanaladas	50
Sondas exploradoras para canal lagrimal	49
STEINHAEUSER Mucotomo	129
STEINHAEUSER Pinzas prensoras de huesos	100
STEINHAEUSER Tensor de mucosa	129
STELLBRINK Pinzas gubias	104
STERNBERG Separador de labios y mejillas	71
STILLE MAYO Tijeras para disección	26
STILLER Cánula aspiración	46
STILLER Compresor	119
STILLER Elevadores para sinus-lift	118-119
STILLER Legra	82
T	
TAYLOR CUSHING Pinzas en forma bayoneta	29



Tensor de mucosa	129
TESSIER Osteótomos	94
TESSIER Separadores de movilización	98
Tijeras finas	20
Tijeras finas para disección	20, 23-24
Tijeras para amígdalas	21
Tijeras para cortar alambre	114
Tijeras para disección	24-26
Tijeras para encías	21
Tijeras quirúrgicas	22-23
TOBOLD Bajalengua	76
TOENNIS-ADSON Tijeras para disección	24
Trépanos	124
U	
UNIV. MINNESOTA CAWOOD Separador de labios y mejillas	72
UNIVERSAL HM Tijera para cortar alambre	114
US-ARMY Separadores	69
V	
Vaso para mezclar	124
VOLKMANN Cucharillas cortantes	89
VOLKMANN Separadores	58, 60
W	
WAGNER Tijeras finas	20
WALTER Pinza para agarrar párpados	32
WANG Legras	116
WANGERIN Posicionador	99
WASSMUND Separador	61
WEIL-BLAKESLEY Pinzas para hueso etmoidal	106
WEITLANER-WULLSTEIN Separadores autoestáticos	74
WIEDER Bajalenguas	76
WILLIAMS BOWMAN Sondas exploradoras para canal lagrimal	49
WILLIGER-KAHRE Legras	83
WILLIGER Legras	85
WOOD CRILE HM Porta-agujas	38
WOOD CRILE Porta-agujas	37
WULLSTEIN WEITLANER Separadores autoestáticos	74
Y	
YOUNG Pinza tiralengua	78
Z	
ZAUFAL-JANSEN Pinza gubia	105

A	
Abaisse-langues	76-79, 117
ADSON-BABY Pincés à dissection	43
ADSON Elévateur	88
ADSON HM Pince anatomique	28
ADSON-MICRO Pincés anatomiques	29
ADSON Pince anatomique	28
ADSON Rugines	83
ADSON-TOENNIS Ciseaux à dissection	24
Alènes	113
Arcs en fil	111
AUFRIEHT Ecarteur nasale	74
AUFRIEHT GUBISCH Ecarteur nasale	74
B	
BABY ADSON Pincés à dissection	43
BABY-CRILE-WOOD HM Porte-aiguille	37
BABY METZENBAUM Ciseaux délicats à dissection	24
BABY-MOSQUITO HARTMANN Pincés hémostatiques	41
BACKHAUS Pincés à champs	43-44
BACKHAUS-ROEDER Pince à champs	44
Baillons	79
BARSKY Crochets à peau	56
BENICKE Ecarteurs fins	55
BENNET Elévateur	87
BEUSE Ciseaux délicats à dissection	23
BEYER Pincés-gouges	103-104
Bistouris	14-16
BLAKE Manche pour bistouri	14
BLAKESLEY WEIL Pincés pour os ethmoïdal	106
BLOCKSMA Crochets	115
BLUME Ostéotome	95
BLUMENTHAL Pincés-gouges	103
BOWMAN Sondes exploratrices pour le canal lacrymal	49
BOWMAN (WILLIAMS) Sondes exploratrices pour le canal lacrymal	49
BROWN Pincés pour saisir le tissu	32
BRUENINGS Ciseaux burins	92
BRUENINGS Spatule à langue	75
BUCHWALD Spatule à langue	75
Bulldog clamps	41
C	
Câbles connecteurs	35
Canules aspiration	46-47
Canules avec olive	46
CASTROVIEJO Compas	109
CASTROVIEJO-EPKER Compas	109
CAWOOD Ecarteur de lèvres et de joues	72

CINELLI Ostéotomes	95
Ciseaux à amygdales	21
Ciseaux à dissection	24-26
Ciseaux à gencive	21
Ciseaux burin pour hémostase	107
Ciseaux burins	91-92
Ciseaux chirurgicaux	22-23
Ciseaux coupe-fil	114
Ciseaux délicats	20
Ciseaux délicats à dissection	20, 23-24
Clamps à rameau	65
Clamps Bulldog	41
Clamps d'adaptation de fragments osseux	97
CLAUDINHA Spatule à langue	80
COLLIN Ecarteur	69
COLLIN Pincés tire-langue	78
Compas	109
Compas à os	108
Compresseur	119
COTTLE-MEDICON Ostéotomes	91
COTTLE Ostéotomes	94
CRILE-WOOD BABY HM Porte-aiguille	37
CRILE-WOOD HM Porte-aiguilles	38
CRILE-WOOD Porte-aiguilles	37
Crochets à mobilisation	98
Crochets à nerfs	54
Crochets à peau	56
Crochets orbitaux	73
Cupule à mélange	124
Curette pour la crête iliaque	124
Curettes tranchantes	89
CUSHING Crochets à nerfs	54
CUSHING Ecarteurs à veines	54-55
CUSHING HM Pincés anatomiques	30
CUSHING Pincés anatomiques	30
CUSHING Pincés chirurgicales	30
CUSHING (TAYLOR) Pince en forme baïonnette	29
D	
DANDY Pincés hémostatiques	41
DAUBENSPECK Curettes tranchantes	89
DAUTREY Arc en fil	111
Daviers à os	100-101
DEAN Ciseaux à amygdales	21
DEBAKEY HM Porte-aiguilles	38
DENHART Ouvre-bouche	80
DENHART-HOEFERT Ouvre-bouche	80
DESMARRES Releveurs à paupières	73
DIEFFENBACH Clamps Bulldog	41
DINGMAN Abaisse-langues	77, 117
DINGMAN Daviers à os	101



DINGMAN Elevateur zygomatique	88
DINGMAN Ouvre-bouche	79
DINGMAN Rugine	82
Dispositif	35
DOCKHORN Ecarteurs de joues	72
DOUGHTY-KILNER Abaisse-langues	77, 117
DOYEN Spatules à langue	75

E

Ecarteur alveolaire	64
Ecarteur pour le bord du maxillaire inférieur	64
Ecarteurs	54-64
Ecarteurs à os	99
Ecarteurs à rameau	66
Ecarteurs à veines	54-55
Ecarteurs autostatiques	74
Ecarteurs d'épine nasale	65
Ecarteurs de lèvres et de joues	71-72
Ecarteurs doubles	69-70
Ecarteurs extra-oraux	68
Ecarteurs fins	54-58
Ecarteurs intra-oraux	68
Ecarteurs mandibulaires	63
Ecarteurs nasaux	74
Ecarteurs pour la crête iliaque	125
Ecarteurs pour parties molles	67
Ecarteurs vestibulaires	71
Elévateur aspirateur	47
Elévateur zygomatique	88
Elévateurs	87-88, 115
Elévateurs pour sinus-lift	118-119
Embouts pour le tournevis	133
EPKER-CASTROVIEJO Compas	109
ERICH Arcs en fil	111

F

FERGUSON FRAZIER Canules aspiration	47
Fibula rugine	128
Fils à os	111
Fixe-menton	63
FOX Ciseaux à gencive	21
Fraises	131
FRAZIER Canules aspiration	47
FRAZIER Crochets à peau	56
FRAZIER (FERGUSON) Canules aspiration	47
FREER Elévateurs	87
FREER-OBWEGESER Elévateurs	87
FREER-OBWEGESER Rugines	82
FREER Rugines	86
FREER-SCHEER Elévateurs	115
FROHN Porte-cotons	50

G

GERALD Pincés anatomiques	30
GILLIES Ecarteurs fins	56
GILLIES Elévateurs	88
GILLIES HM Porte-aiguilles	38
GILLIES Pincés chirurgicales	31
Goniomètre	108
Gouges	124
GROSS Pincés à pansements	45
GUBISCH-AUFRIEHT Ecarteur nasale	74
GUTHRIE Ecarteurs fins	56

H

HAEK-KOFLER Pincés emporte-pièce	107
HAEK Maillets	90
HAKIM Fibula rugines	128
HALSTED-MOSQUITO Pincés hémostatiques	42
HANNA Spatule à langue	80
HARALDSSON Elévateurs aspirateurs	47
HARTMANN Abaisse-langues	78
HARTMANN (BABY-MOSQUITO) Pincés hémostatiques	41
HEGAR-MAYO HM Porte-aiguilles	37
HM Pincés coupe-fil	114
HM Râpe	137
HOEFERT DENHART Ouvre-bouche	80
HOSPITAL PROVIDENCE Pincés hémostatiques	42
HOURIGAN Rugines	82

I

Instruments à mesurer	108-109
Instruments d'aspiration	46-47
Instruments pour fils métalliques	112-114
Instruments pour fissures palatines	115-117
Instruments pour la crête iliaque	124-125
Instruments pour lèvres	115-117

J

JAEGER Plaque à paupières	74
JANSEN ZAUHAL Pince-gouge	105
JOSEPH Ciseaux délicats à dissection	24
JOSEPH Ecarteurs fins	54

K

KAHRE Rugines	115
KAHRE-WILLIGER Rugines	83
KELLY Ciseaux délicats à dissection	24
KELLY Pincés hémostatiques	42
KILNER-DOUGHTY Abaisse-langue	77, 117
KILNER-RAGNELL Ciseaux délicats à dissection	23

KLUBA Crochets orbitaux	73
KLUBA Spéculum	122
KOCHER Ecarteurs	59-60
KOCHER-LANGENBECK Ecarteurs	62
KOELN Ouvre-bouche	117
KOENIG Rugines	84
KOFLER-HAJEK Pince emporte-pièce	107
KRETSCHMER Ecarteurs	63
KRETSCHMER Pivot de référence	110
KRETSCHMER Support	110

L

LAMBOTTE MINI Ostéotomes	91
LAMBOTTE Ostéotomes	92
Lames de bistouris	14-15
Lames de bistouris mini	16
Lames de scie	134-137
LANGENBECK Ecarteurs	59
LANGENBECK Elévateurs	88
LANGENBECK-KOCHER Ecarteurs	62
LANGENBECK-PARKER (US ARMY) Ecarteurs	69
LINDEMANN Fraises	131
LISTON RUSKIN Pincés coupantes à os	102
LOCKLIN Ciseaux à gencive	21
LUCAE Ecarteurs fins	56
LUER Pincés-gouges	103
LUNIATSCHEK Porte-tampons	112

M

MACDONALD Elévateur	87
MAIER Pincés à pansements	45
Maillets	90
Manches pour bistouri s	14-15
Manches pour bistouris mini	16
MARCHAC Ecarteur à os	99
MARQUARDT Pincés-gouges	102
MATHIEU HM Porte-aiguilles	38-39
MAYO Ciseaux à dissection	26
MAYO-HEGAR HM Porte-aiguilles	37
MAYO-STILLE Ciseaux à dissection	26
MCINDOE Pince anatomique	28
MCINDOE Pince coupante à os	102
MCINDOE Rugines	116
MCKESSON Baïllons	79
MEAD Maillets	90
MEAD Pincés-gouges	103
MEDICON-COTTLE Ostéotomes	91
MERSHON Positionneur à fil	112
METZENBAUM-BABY Ciseaux délicats à dissection	24
METZENBAUM-SLIM Ciseaux à dissection	25
MICRO 2000 Pincés	32

MICRO 2000 Porte-aiguilles	40
MICRO-ADSON Pincés anatomiques	29
Micro pincés	32
Micro porte-aiguilles	40
Micro scie à guichet	137
Micro scie oscillante	134
Micro scie sagittale	135
Micro scies	134-139
MICRO-SLIM HM Porte-aiguilles	39
MIDDELDORPF Ecarteurs	61
MILLER-SENN Ecarteurs fins	54
MINI-RUSKIN Pincés-gouges	105
MINI-LAMBOTTE Ostéotomes	91
Mobilisateur pour maxillaire	96
MOD. USA Stylets avec chas	48
MOELTGEN Goniomètre	108
MOLT Rugine	82
MORITZ-SCHMIDT Abaisse-langue	76
MOSQUITO BABY HARTMANN Pincés hémostatiques	41
MOSQUITO HALSTED Pincés hémostatiques	42
Moulins à os	127
Mucotome	129

N

NELATON Sondes cannelées	50
Non-stick pincés bipolaires anti-adhésives	33-34

O

OBWEGESER Alènes	113
OBWEGESER Clamps à rameau	65
OBWEGESER Clamps d'adaptation de fragments osseux	97
OBWEGESER Ecarteur alveolaire	64
OBWEGESER Ecarteur pour le bord du maxillaire inférieur	64
OBWEGESER Ecarteurs à os	99
OBWEGESER Ecarteurs à rameau	66
OBWEGESER Ecarteurs d'épine nasale	65
OBWEGESER Ecarteurs iliaques	125
OBWEGESER Ecarteurs mandibulaires	63
OBWEGESER Ecarteurs pour parties molles	67
OBWEGESER Fixe-menton	63
OBWEGESER-FREER Elévateur	87
OBWEGESER-FREER Rugines	82
OBWEGESER HM Pince à torsader le fil	113
OBWEGESER Mobilisateur pour maxillaire	96
OBWEGESER Ostéotomes	92-94
OBWEGESER Ostéotomes à fendre	93
OBWEGESER Ostéotomes à rameau	93
OBWEGESER Ostéotomes cunéiformes	93
OBWEGESER Ostéotomes en lame	93



OBWEGESER Ostéotomes interdentaires	92
OBWEGESER Ostéotomes pour cloison nasale	96
OBWEGESER Ostéotomes pterygoïdes	93
OBWEGESER	
Pince pour œillets en fil métallique	113
OBWEGESER Rugines	84-86
Osséscalpel	136
Ostéotomes	91-96
Ostéotomes à fendre	93-94
Ostéotomes cunéiformes	93
Ostéotomes cylindriques	126
Ostéotomes en lame	93
Ostéotomes interdentaires	92
Ostéotomes pour cloison nasale	96
Ostéotomes pterygoïdes	93
Ouvre-bouches	79-80, 117
P	
PARKER Ecarteurs	69
PARKER-LANGENBECK (US ARMY) Ecarteurs	69
PARTSCH Ciseaux burins	91
PASSOW Ciseaux burins pour hémostase	107
Pièces à main chirurgicales	131
Pince à saisir les paupières	32
Pince à torsader le fil	113
Pince pour œillets en fil métallique	113
Pincés à champs	43-44
Pincés à dissection	43
Pincés à pansements	45
Pincés à réposition	98
Pincés anatomiques	27-30
Pincés bipolaires anti-adhésives	33-34
Pincés chirurgicales	29-31
Pincés coupantes à os	102
Pincés coupe-fil	114
Pincés emporte-pièce	107
Pincés en forme baïonnette	29
Pincés-gouges	102-105
Pincés hémostatiques	41-42
Pincés micro	32
Pincés nasales	106
Pincés plates	112
Pincés porte-lame	129
Pincés pour os ethmoïdal	106
Pincés pour saisir le tissu	32
Pincés tire-langue	78
Pivot de référence	110
Plaque à paupières	74
Porte-aiguilles	36-40
Porte-aiguilles micro	40
Porte-cotons	50
Porte-forets	124

Positionneur	99
Positionneur à fil	112
POTTS-SMITH HM Pincés anatomiques	28
Poussoir à os	107
PROVIDENCE-HOSPITAL	
Pincés hémostatiques	42
R	
RAGNELL (KILNER)	
Ciseaux délicats à dissection	23
Râpe en carbure de tungstène	137
Râpes nasales	123
Règle pour radiographie	108
Règles	108
Releveurs à paupières	73
ROEDER-BACKHAUS Pincés à champs	44
ROUX Ecarteurs	70
ROWE Pincés à réposition	98
Rugine fibula	128
Rugine pour fissures palatines	115
Rugines	82-86, 115
RUSKIN-LISTON Pincés coupantes à os	102
RUSKIN-MINI Pincés-gouges	105
RUSKIN Pincés-gouges	104-105
S	
SACHSE Micro scie oscillante	134
SACHSE Micro scie sagittale	135
SACHSE Osséscalpel	136
SCHAEFER FREER Elévateur	115
SCHMIDT MORITZ Abaisse-langue	76
SEMB Daviers à os	101
SENN-MILLER Ecarteurs fins	54
Servotronic	130
SHEPARD Ostéotomes cylindriques	126
SHEPARD Perforateurs cortical	126
SILVER Ostéotomes	95
SLIM METZENBAUM Ciseaux à dissection	25
SLIM MICRO HM Porte-aiguilles	39
SMITH Ecarteur à os	99
SMITH POTTS HM Pincés anatomiques	28
Sondes cannelées	50
Sondes exploratrices pour le canal lacrymal	49
Spatules à langue	75, 80
Spéculum	122
STEINHAEUSER Daviers à os	100
STEINHAEUSER Mucotome	129
STEINHAEUSER Tendeur de muqueuse	129
STELLBRINK Pincés-gouges	104
STERNBERG Ecarteur de lèvres et de joues	71
STILLE-MAYO Ciseaux à dissection	26
STILLER Canule aspiration	46

STILLER Compresseur	119
STILLER Elévateurs pour sinus-lift	118-119
STILLER Rugine	82
Stylets avec chas	48
Stylets feuille de myrte	48
Système de micromoteur	130

T

TAYLOR-CUSHING Pince en forme baïonnette	29
Tendeur de muqueuse	129
TESSIER Crochets à mobilisation	98
TESSIER Ostéotomes	94
TOBOLD Abaisse-langue	76
TOENNIS-ADSON Ciseaux à dissection	24
Tournevis angulaire	132-133
Trépans	124

U

UNIV. MINNESOTA CAWOOD Ecarteur de lèvres et de joues	72
UNIVERSAL HM Ciseaux coupe-fil	114
US-ARMY Ecarteurs	69

V

VOLKMANN Curettes tranchantes	89
VOLKMANN Ecarteurs	58, 60

W

WAGNER Ciseaux délicats	20
WALTER Pince à saisir les paupières	32
WANG Rugines	116
WANGERIN Positionneur	99
WASSMUND Ecarteur	61
WEIL-BLAKESLEY Pinces pour os ethmoïdal	106
WEITLANER-WULLSTEIN Ecarteurs autostatiques	74
WIEDER Abaisse-langues	76
WILLIAMS BOWMAN Sondes exploratrices pour le canal lacrymal	49
WILLIGER KAHRE Rugines	83
WILLIGER Rugines	85
WOOD CRILE HM Porte-aiguilles	38
WOOD CRILE Porte-aiguilles	37
WULLSTEIN WEITLANER Ecarteurs autostatiques	74

Y

YOUNG Pince tire-langue	78
-------------------------	----

Z

ZAUFAL-JANSEN Pince-gouge	105
---------------------------	-----





A	
Abassalingua	76-79, 117
ADSON-BABY Pinze per dissezione	43
ADSON Elevatore	88
ADSON HM Pinza anatomica	28
ADSON MICRO Pinze anatomiche	29
ADSON Periostotomi	83
ADSON Pinza anatomica	28
ADSON-TOENNIS Forbici per dissezione	24
Apribocca	79-80, 117
Arci di filo	111
AUFRICHT Divaricatori nasale	74
AUFRICHT GUBISCH Divaricatori nasale	74
B	
BABY ADSON Pinze per dissezione	43
BABY-CRILE-WOOD HM Portaghi	37
BABY-METZENBAUM Forbici delicate per dissezione	24
BABY-MOSQUITO HARTMANN Pinze emostatiche	41
BACKHAUS Pinze fissateli	43-44
BACKHAUS-ROEDER Pinza fissateli	44
BARSKY Uncini per pelle	56
BENICKE Divaricatori delicati	55
BENNET Elevatore	87
BEUSE Forbici delicate per dissezione	23
BEYER Pinze sgorbie	103-104
Bisturi	14-16
BLAKE Manico per bisturi	14
BLAKESLEY WEIL Pinze per osso etmoidale	106
BLOCKSMA Uncini	115
BLUME Osteotomo	95
BLUMENTHAL Pinze sgorbie	103
BOWMAN Sonde esploratrici per canale lacrimale	49
BOWMAN (WILLIAMS) Sonde esploratrici per canale lacrimale	49
BROWN Pinze per afferrare tessuti	32
BRUENINGS Scalpelli	92
BRUENINGS Spatola per lingua	75
BUCHWALD Spatola per lingua	75
Bulldog pinze	41
C	
Cacciaviti angolati	132-133
Cannule aspirazione	46-47
Cannule con oliva	46
CASTROVIEJO Compassi	109
CASTROVIEJO-EPKER Compassi	109
Cavi di connessione	35
CAWOOD Divaricatore di labbra e guance	72

CINELLI Osteotomi	95
CLAUDINHA Spatola per lingua	80
COLLIN Divaricatore	69
COLLIN Pinza tiringua	78
Compassi	109
Compasso per ossa	108
Compressore	119
COTTLE-MEDICON Osteotomi	91
COTTLE Osteotomi	94
CRILE-WOOD BABY HM Portaghi	37
CRILE-WOOD HM Portaghi	38
CRILE-WOOD Portaghi	37
Cucchiari taglienti	89
Cucchiaio per la cresta iliaca	124
CUSHING Divaricatori per vene	54-55
CUSHING HM Pinze anatomiche	30
CUSHING Pinze anatomiche	30
CUSHING Pinze chirurgiche	30
CUSHING (TAYLOR) Pinza a forma di baionetta	29
CUSHING Uncini per nervi	54
D	
DANDY Pinze emostatiche	41
DAUBENSPECK Cucchiari taglienti	89
DAUTREY Archi di filo	111
DEAN Forbice per tonsille	21
DEBAKEY HM Portaghi	38
DENHART Apribocca	80
DENHART-HOEFERT Apribocca	80
DESMARRES Elevatori per palpebre	73
DIEFFENBACH Pinze Bulldog	41
DINGMAN Abassalingua	77, 117
DINGMAN Apribocca	79
DINGMAN Elevatore zigomatico	88
DINGMAN Periostotomo	82
DINGMAN Tenaglie per ossa	101
Dispositivo	35
Divaricatore per il bordo della mascella inferiore	64
Divaricatore per spina nasale	65
Divaricatori	54-64
Divaricatori autostatici	74
Divaricatori delicati	54-58
Divaricatori doppi	69-70
Divaricatori extraorali	68
Divaricatori intraorali	68
Divaricatori nasali	74
Divaricatori osseo	99
Divaricatori per cresta iliaca	125
Divaricatori per labbra e guance	71-72
Divaricatori per mobilizzazione	98
Divaricatori per ramo	66
Divaricatori per tessuti molli	67

Divaricatori per vene	54-55
Divaricatori vestibulari	71
DOCKHORN Divaricatori delle guance	72
DOUGHTY KILNER Abassalingua	77, 117
DOYEN Spatole per lingua	75

E

Elevatore con aspirazione	47
Elevatore zigomatico	88
Elevatori	87-88, 115
Elevatori per palpebre	73
Elevatori per sinus-lifting	118-119
EPKER CASTROVIEJO Compassi	109
ERICH Archi di filo	111

F

FERGUSSON FRAZIER Cannula aspirazione	47
Fibula periostotomo	128
Fili per ossa	111
Forbici chirurgiche	22-23
Forbici delicate	20
Forbici delicate per dissezione	20, 23-24
Forbici per dissezione	24-26
Forbici per fili d'acciaio	114
Forbici per gengiva	21
Forbici per tonsille	21
FOX Forbici per gengiva	21
FRAZIER Cannule aspirazione	47
FRAZIER (FERGUSSON) Cannule aspirazione	47
FRAZIER Uncino per pelle	56
FREER Elevatori	87
FREER OBWEGESER Elevatori	87
FREER OBWEGESER Periostotomi	82
FREER Periostotomo	86
FREER-SCHEER Elevatore	115
Frese	131
FROHN Portacotone	50

G

Gancio per mento	63
GERALD Pinze anatomiche	30
GILLIES Divaricatori delicati	56
GILLIES Elevatore	88
GILLIES HM Portaghi	38
GILLIES Pinza chirurgica	31
Goniometro	108
GROSS Pinze per medicazione	45
GUBISCH-AUFRICHT Divaricatore nasale	74
GUTHRIE Divaricatori delicati	56

H

HAJEK-KOFLER Pinza tagliente	107
------------------------------	-----

HAJEK Martello	90
HAKIM Fibula periostotomi	128
HALSTED-MOSQUITO Pinze emostatiche	42
HANNA Spatola per lingua	80
HARALDSSON Elevatore aspiratore	47
HARTMANN Abassalingua	78
HARTMANN (BABY-MOSQUITO) Pinze emostatiche	41
HEGAR MAYO HM Portaghi	37
HM Pinze per tagliare fili d'acciaio	114
HM Raspa	137
HOEFERT-DENHART Apribocca	80
HOSPITAL PROVIDENCE Pinze emostatiche	42
HOURIGAN Periostotomi	82

I

Impattatori per ossa	107
Inseri per cacciavite	133

J

JAEGER Piastra per palpebre	74
JANSEN ZAUFAL Pinza sgorbia	105
JOSEPH Divaricatori delicati	54
JOSEPH Forbici delicate per dissezione	24

K

KAHRE Periostotomo	115
KAHRE-WILLIGER Periostotomi	83
KELLY Forbici delicate per dissezione	24
KELLY Pinze emostatiche	42
KILNER-DOUGHTY Abassalingua	77, 117
KILNER-RAGNELL Forbici delicate per dissezione	23
KLUBA Retrattori orbitale	73
KLUBA Specolo	122
KOCHER Divaricatori	59-60
KOCHER LANGENBECK Divaricatori	62
KOELN Apribocca	117
KOENIG Periostotomo	84
KOFLER-HAJEK Pinza tagliente	107
KRETSCHMER Divaricatore	63
KRETSCHMER Perno di referenza	110
KRETSCHMER Sostegno	110

L

LAMBOTTE-MINI Osteotomi	91
LAMBOTTE Osteotomi	92
Lame da sega	134-137
Lame per bisturi	14-15
Lame per bisturi mini	16
LANGENBECK Divaricatori	59
LANGENBECK Elevatori	88



LANGENBECK-KOCHER Divaricatori	62
LANGENBECK-PARKER (US ARMY) Divaricatori	69
LINDEMANN Frese	131
LISTON RUSKIN Pinze ossivore	102
LOCKLIN Forbici per gengiva	21
LUCAE Divaricatori delicati	56
LUER Pinze sgorbie	103
LUNIATSCHEK Portatampone	112

M

MACDONALD Elevatore	87
MAIER Pinze per medicazione	45
Manici per bisturi	14-15
Manici per bisturi mini	16
Manipoli chirurgici	131
MARCHAC Separatore osseo	99
MARQUARDT Pinze sgorbie	102
Martelli	90
MATHIEU HM Portaghi	38-39
MAYO Forbici per dissezione	26
MAYO-HEGAR HM Portaghi	37
MAYO-STILLE Forbici per dissezione	26
MCINDOE Periostotomi	116
MCINDOE Pinza anatomica	28
MCINDOE Pinza ossivore	102
MCKESSON Apribocca	79
MEAD Martelli	90
MEAD Pinze sgorbie	103
MEDICON COTTLE Osteotomi	91
MERSHON Posizionatore per filo	112
METZENBAUM BABY Forbici delicate per dissezione	24
METZENBAUM-SLIM Forbici per dissezione	25
MICRO 2000 Pinze	32
MICRO 2000 Portaghi	40
MICRO-ADSON Pinze anatomiche	29
Micro pinze	32
Micro portaghi	40
Micro sega	137
Micro sega oscillante	134
Micro sega sagittale	135
Micro seghe	134-139
MICRO SLIM HM Portaghi	39
MIDDELDORPF Divaricatori	61
MILLER-SENN Divaricatori delicati	54
MINI-LAMBOTTE Osteotomi	91
MINI RUSKIN Pinze sgorbie	105
Mobilizzatore per mascella	96
MOD. USA Specilli con ansa	48
MOELTGEN Goniometro	108
MOLT Periostotomo	82

MORITZ-SCHMIDT Abassalingua	76
MOSQUITO BABY HARTMANN Pinze emostatiche	41
MOSQUITO HALSTED Pinze emostatiche	42
Mucotomo	129
Mulini per ossa	127

N

NELATON Sonde scanalate	50
Non-stick pinze bipolari antiaderenti	33-34

O

OBWEGESER Divaricatore per il bordo della mascella inferiore	64
OBWEGESER Divaricatore osseo	99
OBWEGESER Divaricatori mandibolari	63
OBWEGESER Divaricatori per cresta iliaca	125
OBWEGESER Divaricatori per ramo	66
OBWEGESER Divaricatori per spina nasale	65
OBWEGESER Divaricatori per tessuti molli	67
OBWEGESER-FREER Elevatori	87
OBWEGESER-FREER Periostotomi	82
OBWEGESER Gancio per mento	63
OBWEGESER HM Pinza per torcere fili	113
OBWEGESER Mobilizzatore per mascella	96
OBWEGESER Osteotomi	92-94
OBWEGESER Osteotomi a forma di cuneo	93
OBWEGESER Osteotomi a forma di lama	93
OBWEGESER Osteotomi per splittaggio osseo	93
OBWEGESER Osteotomi interdentali	92
OBWEGESER Osteotomi per ramo	93
OBWEGESER Osteotomi per setto nasale	96
OBWEGESER Osteotomi per tubercolo	93
OBWEGESER Osteotomi pterigoidei	93
OBWEGESER Periostotomi	84-86
OBWEGESER Pinza occhiello per filo metallico	113
OBWEGESER Pinze per avvicinare frammenti	97
OBWEGESER Pinze per ramus	65
OBWEGESER Punteruoli	113
OBWEGESER Uncino alveolare	64
Osseoscalpello	136
Osteotomi	91-96
Osteotomi a forma di cuneo	93
Osteotomi a forma di lama	93
Osteotomi cilindrici	126
Osteotomi interdentali	92
Osteotomi per setto nasale	96
Osteotomi per splittaggio osseo	93-94
Osteotomi per tubercolo	93
Osteotomi pterigoidei	93

P	
PARKER Divaricatori	69
PARKER-LANGENBECK (US ARMY) Divaricatori	69
PARTSCH Scalpelli	91
PASSOW Scalpelli per emostasi	107
Periostotomi	82-86, 115
Periostotomi per fessura del palato	115
Periostotomo fibula	128
Perno di referenza	110
Piastra per palpebre	74
Pinza occhiello per filo metallico	113
Pinza per torcere fili	113
Pinze a forma di baionetta	29
Pinze anatomiche	27-30
Pinze bipolari antiaderenti	33-34
Pinze Bulldog	41
Pinze chirurgiche	29-31
Pinze d'addattamento	97
Pinze emostatiche	41-42
Pinze fissateli	43-44
Pinze micro	32
Pinze nasali	106
Pinze ossivore	102
Pinze per afferrare palpebre	32
Pinze per afferrare tessuti	32
Pinze per avvicinare frammenti	97
Pinze per dissezione	43
Pinze per medicazione	45
Pinze per osso etmoidale	106
Pinze per ramo	65
Pinze per riposizione	98
Pinze per tagliare fili d'acciaio	114
Pinze portalame	129
Pinze sgorbie	102-105
Pinze taglienti	107
Pinze tiralingua	78
Portacotone	50
Portaghi	36-40
Portaghi micro	40
Posizionatore	99
Posizionatore per filo	112
POTTS-SMITH HM Pinze anatomiche	28
PROVIDENCE-HOSPITAL Pinze emostatiche	42
Punteruoli	113
R	
RAGNELL (KILNER) Forbici delicate per dissezione	23
Raspa in carburo di tungsteno	137
Raspe nasali	123
Retrattori orbitale	73

Righe	108
Righello per radiografia	108
ROEDER BACKHAUS Pinza fissateli	44
ROUX Divaricatori	70
ROWE Pinze per riposizione	98
RUSKIN-LISTON Pinze ossivore	102
RUSKIN-MINI Pinze sgorbie	105
RUSKIN Pinze sgorbie	104-105
S	
SACHSE Micro sega oscillante	134
SACHSE Micro sega sagittale	135
SACHSE Osseoscalpello	136
Scalpelli	91-92
Scalpelli per emostasi	107
SCHEER FREER Elevatore	115
SCHMIDT MORITZ Abassalingua	76
Scodella per miscelare	124
SEMB Tenaglie per ossa	101
SENN-MILLER Divaricatori delicati	54
Separatori mandibolari	63
Servotronic	130
Sgorbia	124
SHEPARD Osteotomi cilindrici	126
SHEPARD Perforatore corticale	126
SILVER Osteotomi	95
Sistema micromotore	130
SLIM METZENBAUM Forbici per dissezione	25
SLIM MICRO HM Portaghi	39
SMITH POTTS HM Pinze anatomiche	28
SMITH Separatore osseo	99
Sonde esploratrici per canale lacrimale	49
Spatole per lingua	75, 80
Specilli a foglia di mirto	48
Specilli con ansa	48
Specilli scanalati	50
Specolo	122
STEINHAEUSER Mucotomo	129
STEINHAEUSER Tenaglie per ossa	100
STEINHAEUSER Tenditore di mucosa	129
STELLBRINK Pinze sgorbie	104
STERNBERG Divaricatore di labbra e guance	71
STILLE MAYO Forbici per dissezione	26
STILLER Cannula aspirazione	46
STILLER Compressore	119
STILLER Elevatori per sinus-lifting	118-119
STILLER Periostotomo	82
Strumenti per aspirazione	46-47
Strumenti per fessure del palato	115-117
Strumenti per fili	112-114
Strumenti per la cresta iliaca	124-125
Strumenti per labbra	115-117



Strumenti per marcare	110
Strumenti per misurare	108-109
Supporto perforatori	124
T	
TAYLOR CUSHING Pinza a forma di baionetta	29
Tenaglia piatta	112
Tenaglie per ossa	100-101
Tenditore di mucosa	129
TESSIER Divaricatori per mobilizzazione	98
TESSIER Osteotomi	94
TOBOLD Abassalingua	76
TOENNIS-ADSON Forbici per dissezione	24
Trapani	124
U	
Uncini per nervi	54
Uncini per pelle	56
Uncino alveolare	64
UNIV. MINNESOTA CAWOOD Divaricatore di labbra e guance	72
UNIVERSAL HM Forbice per fili d'acciaio	114
US-ARMY Divaricatori	69
V	
VOLKMANN Cucchiali taglienti	89
VOLKMANN Divaricatori	58, 60
W	
WAGNER Forbice delicata	20
WALTER Pinza per afferrare palpebre	32
WANG Periostotomi	116
WANGERIN Posizionatore	99
WASSMUND Divaricatore	61
WEIL-BLAKESLEY Pinze per osso etmoidale	106
WEITLANER-WULLSTEIN Divaricatori autostatici	74
WIEDER Abassalingua	76
WILLIAMS BOWMAN Sonde esploratrici per canale lacrimale	49
WILLIGER KAHRE Periostotomi	83
WILLIGER Periostotomi	85
WOOD CRILE HM Portaghi	38
WOOD CRILE Portaghi	37
WULLSTEIN WEITLANER Divaricatori autostatici	74
Y	
YOUNG Pinze tirlingua	78
Z	
ZAUFAL-JANSEN Pinza sgorbia	105



MEDICON

instruments

OMF SURGERY





NUMERICAL INDEX



Numerischer Index
Numerical Index
Indice numérico
Index numérique
Indice numerico

01.22.10	14	03.56.15	26	06.11.16	31	09.20.16	50
01.22.11	14	03.56.65	26	06.11.20	31	09.60.08	46
01.22.12	14	03.57.15	26	06.11.84	31	09.60.10	46
01.22.15	14	03.57.65	26	06.11.86	31	09.60.12	46
01.22.18	15	04.13.13	23	06.20.12	28	09.60.14	46
01.22.19	15	04.13.15	23	06.20.62	28	09.60.16	46
01.22.20	15	04.32.11	24	06.22.12	29	09.60.18	46
01.22.21	15	04.33.11	24	06.22.15	29	09.79.70	46
01.22.22	15	04.34.14	25	06.23.12	29	09.79.71	46
01.22.23	15	04.34.18	25	06.23.15	29	09.79.72	46
01.22.24	15	04.34.20	25	06.40.15	28	09.79.73	46
01.22.25	15	04.34.64	25	06.40.85	31	09.79.74	46
01.27.03	14	04.34.68	25	06.60.17	30	09.79.75	46
01.27.07	14	04.34.70	25	06.60.18	30	09.79.76	46
01.27.13	14	04.35.14	25	06.60.68	30	09.79.85	46
01.27.17	14	04.35.18	25	06.60.69	30	09.83.07	46
01.27.23	14	04.35.20	25	06.60.87	30	09.83.26	47
01.27.40	14	04.35.64	25	06.60.88	30	09.83.28	47
01.28.04	15	04.35.68	25	06.60.90	30	09.83.30	47
01.28.14	15	04.35.70	25	06.60.91	30	09.83.32	47
01.28.24	15	04.50.15	24	06.60.92	30	09.83.34	47
01.30.32	16	04.51.15	24	06.60.93	30	09.83.56	47
01.30.36	16	04.54.16	24	07.10.15	32	09.83.58	47
01.30.38	14	04.55.16	24	07.10.20	32	09.83.60	47
01.30.65	16	04.63.18	24	07.10.25	32	09.83.62	47
01.30.67	16	04.63.68	24	07.26.18	29	10.18.65	37
02.06.12	20	04.80.13	21	07.64.03	32	10.18.68	37
02.07.12	20	04.81.13	21	07.64.04	32	10.18.70	37
02.26.12	20	04.83.17	21	07.64.13	32	10.18.73	37
02.27.12	20	04.83.27	21	07.64.14	32	10.18.74	37
02.40.12	20	06.00.11	27	09.08.13	48	10.18.76	37
02.40.62	20	06.00.13	27	09.08.14	48	10.18.80	37
02.41.12	20	06.00.14	27	09.08.16	48	10.18.85	37
02.41.62	20	06.00.15	27	09.08.20	48	10.18.88	37
02.70.14	23	06.00.16	27	09.08.24	48	10.18.90	37
02.71.14	23	06.00.18	27	09.10.13	48	10.18.93	37
03.02.14	22	06.02.11	27	09.10.14	48	10.20.15	37
03.02.64	22	06.02.13	27	09.10.16	48	10.20.18	37
03.03.14	22	06.02.14	27	09.10.20	48	10.20.20	37
03.03.64	22	06.02.15	27	09.11.13	48	10.20.23	37
03.04.14	22	06.02.16	27	09.11.14	48	10.20.64	37
03.04.64	22	06.02.18	27	09.11.15	48	10.20.65	38
03.05.14	22	06.03.65	28	09.11.18	48	10.20.68	38
03.05.64	22	06.03.68	28	09.11.20	48	10.20.70	38
03.06.14	23	06.03.73	28	09.15.11	50	10.20.73	38
03.06.64	23	06.10.13	31	09.15.14	50	10.20.75	38
03.07.14	23	06.10.14	31	09.15.16	50	10.20.76	38
03.07.64	23	06.10.16	31	09.15.18	50	10.20.80	38
03.50.14	26	06.10.18	31	09.15.20	50	10.24.65	39
03.50.64	26	06.10.20	31	09.16.66	50	10.24.66	39
03.51.14	26	06.11.13	31	09.20.12	50	10.24.68	39
03.51.64	26	06.11.14	31	09.20.14	50	10.24.69	39

10.24.70	39	19.14.26	45	20.66.02	57	24.26.14	74
10.24.71	39	19.15.20	45	20.66.03	57	26.29.07	88
10.24.73	39	19.15.26	45	20.66.04	57	26.29.10	88
10.59.65	38	19.16.20	45	20.67.01	57	26.35.00	115
11.20.64	39	19.16.26	45	20.67.02	57	26.35.01	86
11.20.67	39	19.17.20	45	20.67.03	57	26.35.02	87
11.20.70	39	19.17.26	45	20.67.04	57	26.35.03	87
11.20.74	39	20.05.08	54	22.12.15	69	26.37.07	82
11.22.64	38	20.05.09	54	22.14.13	69	26.37.08	82
11.22.67	38	20.17.08	55	22.14.18	69	26.37.12	87
11.22.70	38	20.17.10	55	22.16.00	70	26.37.90	87
12.18.66	40	20.17.12	55	22.16.14	70	26.40.06	84
12.18.67	40	20.17.14	55	22.16.15	70	26.42.03	85
12.18.68	40	20.17.16	55	22.16.16	70	26.42.05	85
12.18.69	40	20.17.18	55	22.18.21	69	26.42.07	85
12.18.74	40	20.17.28	55	22.30.02	60	26.42.14	83
12.18.75	40	20.17.30	55	22.30.03	60	26.42.15	83
14.23.62	114	20.17.32	55	22.30.04	60	26.42.56	83
14.30.11	114	20.17.34	55	22.31.02	60	26.42.58	83
14.30.13	114	20.17.36	55	22.31.03	60	26.48.01	83
14.30.17	114	20.17.38	55	22.31.04	60	26.48.02	88
14.46.14	112	20.17.50	54	22.34.01	58	26.48.03	83
15.10.38	41	20.22.01	56	22.34.51	58	26.48.04	83
15.10.51	41	20.22.02	56	22.35.01	58	27.04.20	90
15.11.38	41	20.22.03	56	22.42.01	59	27.06.20	90
15.11.51	41	20.22.31	54	22.43.01	59	27.06.30	90
15.12.55	41	20.22.32	54	23.05.10	59	27.10.31	90
15.13.55	41	20.30.12	56	23.05.14	59	27.10.32	90
15.32.09	41	20.30.19	56	23.05.16	59	27.57.02	91
15.33.09	41	20.30.20	56	23.21.01	60	27.57.04	91
15.44.12	42	20.35.01	56	23.21.02	60	27.57.06	91
15.44.14	42	20.35.02	56	23.25.01	62	27.57.08	91
15.45.12	42	20.48.10	55	23.25.02	62	27.57.10	91
15.45.14	42	20.48.11	55	23.25.03	62	27.57.12	91
15.46.12	42	20.50.02	54	23.25.04	62	27.57.15	91
15.47.12	42	20.50.05	54	23.25.05	62	27.57.90	91
15.50.14	42	20.50.07	54	23.25.06	62	27.61.02	91
15.51.14	42	20.50.10	54	23.25.07	62	27.61.03	91
15.70.14	42	20.52.10	56	23.25.08	62	27.61.04	91
15.71.14	42	20.52.11	56	23.25.09	62	27.61.06	91
16.11.84	41	20.53.42	58	23.25.10	62	27.61.08	91
16.11.94	41	20.53.43	58	23.25.11	62	27.64.04	91
17.05.14	43	20.53.50	58	23.25.12	62	27.64.07	91
17.05.19	43	20.64.01	57	23.25.13	62	27.64.09	91
17.55.08	43	20.64.02	57	23.25.14	62	27.64.12	91
17.55.10	43	20.64.03	57	23.33.01	61	27.92.04	92
17.55.13	43	20.64.04	57	23.33.02	61	27.92.06	92
17.55.15	43	20.65.01	57	23.33.03	61	27.92.08	92
17.55.20	44	20.65.02	57	23.33.11	61	27.92.10	92
17.55.23	44	20.65.03	57	23.33.12	61	27.95.03	107
17.55.83	44	20.65.04	57	23.33.13	61	27.95.05	107
19.14.20	45	20.66.01	57	24.26.13	74	27.95.07	107



27.95.09	107	31.11.04	103	60.34.18	49	67.38.11	95
27.95.11	107	31.11.05	105	60.34.21	49	67.38.12	95
27.95.12	107	31.11.13	102	60.34.22	49	67.61.00	123
28.62.26	124	33.56.18	102	60.34.24	49	67.61.01	123
28.94.04	92	33.57.18	102	60.34.26	49	67.61.03	123
28.94.06	92	33.59.17	102	60.34.28	49	67.61.10	123
28.94.08	92	35.11.13	100	60.34.31	49	67.61.11	123
28.94.10	92	35.11.14	100	60.34.32	49	67.61.12	123
28.94.12	92	35.15.18	101	60.34.34	49	67.61.13	123
28.94.15	92	35.15.19	101	60.34.36	49	67.61.14	123
28.94.20	92	35.20.20	101	60.34.38	49	67.61.15	123
28.94.25	92	35.24.20	101	60.55.40	32	67.61.16	123
28.94.30	92	44.37.15	108	63.45.07	131	67.61.17	123
28.94.40	92	44.37.20	108	63.45.11	131	67.61.18	123
28.94.44	92	44.37.30	108	63.45.13	131	67.61.19	123
28.94.50	92	44.37.50	108	63.45.15	131	68.01.20	65
29.51.24	89	44.37.95	108	63.90.70	124	68.01.25	66
29.51.33	89	44.38.10	108	63.90.80	124	68.01.31	67
29.51.42	89	44.38.40	108	66.01.20	122	68.01.32	67
29.51.50	89	45.52.30	117	66.28.01	106	68.01.33	67
29.51.51	89	45.52.31	117	66.28.02	106	68.01.34	67
29.51.52	89	45.57.11	77, 117	66.28.03	106	68.01.35	67
29.51.53	89	45.57.12	77	66.28.04	106	68.01.36	67
29.51.54	89	45.57.13	77	66.28.05	106	68.01.37	67
29.51.55	89	45.57.14	77	66.28.11	106	68.01.41	67
29.51.56	89	45.57.15	77	66.28.12	106	68.01.42	67
29.51.60	124	45.81.17	78	66.28.13	106	68.01.43	67
29.68.42	89	45.82.16	78	66.28.14	106	68.01.44	67
29.68.50	89	45.82.17	78	66.28.31	106	68.01.45	67
29.68.51	89	46.35.22	124	66.28.32	106	68.01.46	67
29.68.52	89	47.50.60	124	66.28.33	106	68.01.47	67
30.07.14	102	60.00.40	109	66.28.34	106	68.01.53	64
30.07.15	102	60.00.41	109	66.28.71	106	68.01.56	66
30.15.14	103	60.00.42	109	66.28.72	106	68.01.57	66
30.15.17	103	60.00.43	109	66.28.73	106	68.01.63	64
30.25.30	103	60.05.10	73	66.28.74	106	68.01.65	65
30.25.45	103	60.05.11	73	66.28.75	106	68.01.67	125
30.25.90	103	60.05.12	73	66.28.81	106	68.01.68	125
30.30.15	103	60.05.13	73	66.28.82	106	68.01.72	65
30.30.35	103	60.05.14	73	66.28.83	106	68.01.73	65
30.71.02	104	60.05.95	74	66.28.84	106	68.01.80	63
30.71.03	104	60.34.00	49	66.38.10	106	68.01.81	63
30.76.17	104	60.34.01	49	67.15.98	47	68.01.82	63
30.76.18	104	60.34.02	49	67.21.33	74	68.01.97	71
31.04.02	105	60.34.04	49	67.21.35	74	68.01.98	71
31.04.03	105	60.34.06	49	67.32.80	94	68.01.99	71
31.05.02	105	60.34.08	49	67.37.10	95	68.02.00	82
31.05.03	105	60.34.10	49	67.37.12	95	68.02.01	84
31.06.05	105	60.34.11	49	67.37.14	95	68.02.02	84
31.06.25	104	60.34.12	49	67.37.16	95	68.02.03	84
31.07.05	105	60.34.14	49	67.37.20	95	68.02.04	84
31.07.25	104	60.34.16	49	67.38.10	95	68.02.06	85

68.02.07	85	68.04.76	113	68.30.07	132	68.82.55	118
68.02.08	86	68.04.93	111	68.30.08	132	68.82.56	119
68.02.09	86	68.05.20	99	68.30.10	132	68.82.57	119
68.02.11	84	68.05.30	63	68.30.18	133	68.82.58	119
68.02.12	84	68.09.05	82	68.30.19	133	68.82.75	127
68.02.13	84	68.09.20	88	68.30.20	133	68.82.76	127
68.02.19	87	68.15.05	111	68.30.21	133	68.82.81	116
68.02.20	82	68.15.10	111	68.30.34	133	68.82.82	116
68.02.21	82	68.15.50	112	68.30.36	133	68.82.83	116
68.02.22	82	68.18.91	61	68.30.37	133	68.82.84	116
68.02.24	86	68.18.92	72	68.30.38	133	68.84.00	110
68.02.25	86	68.18.93	72	68.30.39	133	68.84.05	110
68.02.31	85	68.24.00	134	68.30.41	133	68.84.06	110
68.02.33	85	68.24.02	135	68.30.43	133	72.00.01	75
68.02.40	128	68.24.05	136	68.30.44	133	72.00.10	75
68.02.69	68	68.24.10	137	68.30.47	133	72.00.15	75
68.02.70	68	68.24.12	137	68.30.48	133	72.00.18	75
68.02.73	68	68.24.13	137	68.30.49	133	72.00.27	75
68.02.74	68	68.24.14	137	68.30.50	133	72.00.28	75
68.02.75	68	68.24.15	137	68.30.51	133	72.00.50	75
68.02.76	68	68.24.16	137	68.30.52	133	72.00.52	80
68.02.77	68	68.24.19	134-137	68.30.53	133	72.00.56	80
68.02.78	68	68.24.20	134-137	68.40.01	97	72.00.85	76
68.03.02	92	68.24.21	137	68.40.02	97	72.01.15	76
68.03.04	92	68.24.22	137	68.40.04	99	72.01.25	78
68.03.07	93	68.24.24	134	68.40.08	99	72.01.40	76
68.03.10	93	68.24.25	134	68.40.10	99	72.01.41	76
68.03.12	93	68.24.26	134	68.45.10	88	72.02.10	72
68.03.13	93	68.24.27	134	68.50.01	98	72.02.15	71
68.03.14	93	68.24.28	134	68.50.02	98	72.05.60	80
68.03.16	93	68.24.29	134	68.50.03	98	72.05.63	80
68.03.17	93	68.24.30	134	68.50.04	98	72.08.00	79
68.03.18	93	68.24.31	134	68.51.01	98	72.08.11	77, 79, 117
68.03.29	96	68.24.35	136	68.51.02	98	72.08.12	77, 79, 117
68.03.30	93	68.24.36	136	68.61.01	131	72.08.13	77, 79, 117
68.03.31	93	68.24.37	136	68.61.02	131	72.08.20	79
68.03.32	93	68.24.70	135	68.61.03	131	72.10.01	79
68.03.34	94	68.24.71	135	68.81.31	115	72.10.02	79
68.03.35	94	68.24.72	135	68.81.32	115	72.10.03	79
68.03.39	92	68.24.73	135	68.82.11	115	72.45.50	21
68.03.50	94	68.24.74	135	68.82.12	115	76.01.03	111
68.03.51	94	68.24.75	135	68.82.20	115	76.01.04	111
68.03.52	94	68.25.03	129	68.82.25	116	76.01.05	111
68.03.53	94	68.25.15	129	68.82.27	116	78.41.02	126
68.03.71	96	68.25.17	129	68.82.31	73	78.41.05	126
68.03.72	96	68.25.20	129	68.82.32	73	78.41.06	126
68.03.73	96	68.25.21	129	68.82.33	73	78.41.08	126
68.03.76	96	68.25.88	100	68.82.49	118	78.41.11	126
68.04.05	113	68.25.89	100	68.82.50	118	78.41.12	126
68.04.10	113	68.30.01	132	68.82.51	118	78.41.13	126
68.04.15	113	68.30.05	132	68.82.53	118	78.41.14	126
68.04.73	113	68.30.06	132	68.82.54	118	78.41.15	126



Numerischer Index
Numerical Index
Indice numérico
Index numérique
Indice numerico

78.41.16	126	204.34.20	25
78.41.18	126	204.34.64	25
88.00.20	35	204.34.68	25
88.00.21	35	204.34.70	25
88.00.22	35	204.35.14	25
88.00.24	35	204.35.18	25
88.00.40	35	204.35.20	25
88.07.02	34	204.35.64	25
88.07.03	34	204.35.68	25
88.07.07	34	204.35.70	25
88.07.08	34	204.63.18	24
88.07.12	34	204.63.68	24
88.07.13	34	212.40.12	20
88.08.01	34	212.41.12	20
88.08.02	34	213.02.14	22
88.08.03	34	213.03.14	22
88.08.04	34	213.04.14	22
88.08.05	34	213.05.14	22
88.08.06	34	213.06.14	23
88.08.07	34	213.07.14	23
88.08.08	34	213.50.14	26
88.08.09	34	213.51.14	26
88.08.10	34	213.56.15	26
88.08.11	34	213.57.15	26
88.08.12	34	214.34.14	25
88.08.13	34	214.34.18	25
88.08.14	34	214.34.20	25
88.08.15	34	214.35.14	25
92.11.10	130	214.35.18	25
92.11.20	130	214.35.20	25
92.11.27	130	214.63.18	24
92.20.25	130	222.40.62	20
202.40.12	20	222.41.62	20
202.40.62	20	223.50.64	26
202.41.12	20	223.51.64	26
202.41.62	20	223.56.65	26
203.02.14	22	223.57.65	26
203.03.14	22	224.35.64	25
203.04.14	22	224.35.68	25
203.05.14	22	224.35.70	25
203.06.14	23	224.63.68	24
203.07.14	23	330.01.80	112
203.50.14	26	330.01.85	112
203.50.64	26	330.01.86	112
203.51.14	26		
203.51.64	26		
203.56.15	26		
203.56.65	26		
203.57.15	26		
203.57.65	26		
204.34.14	25		
204.34.18	25		

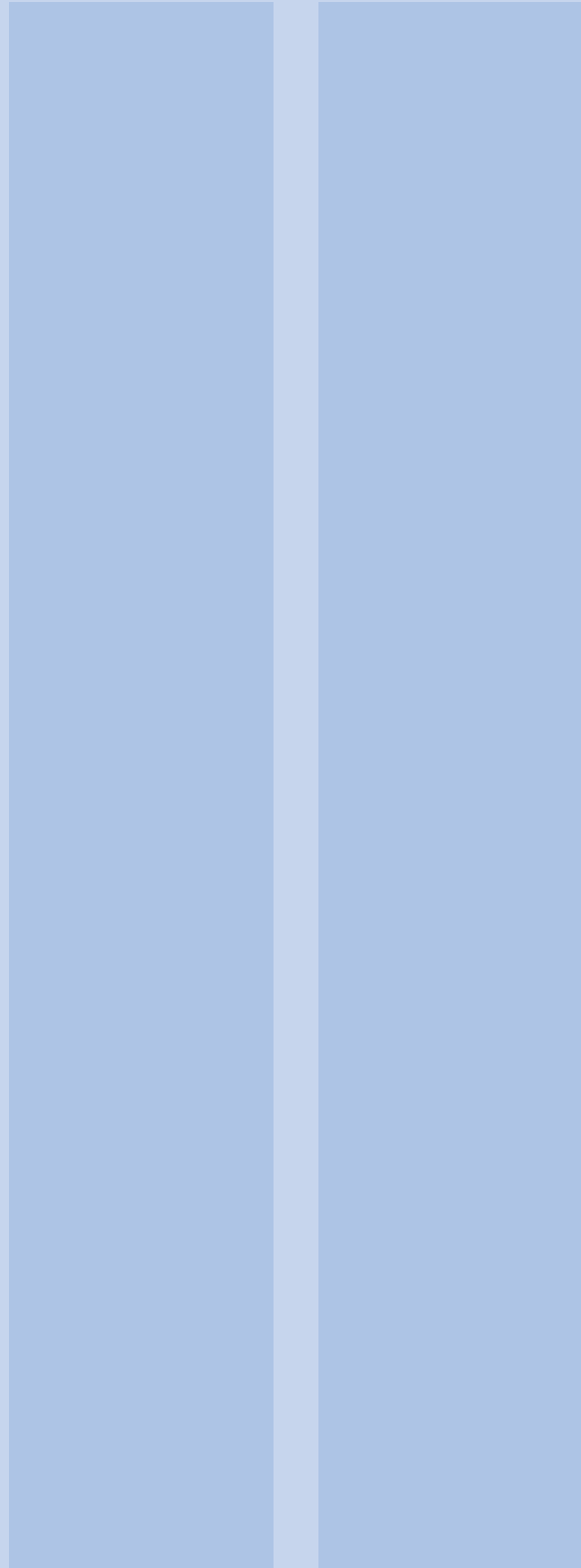

e-mail: sales@medicon.de

internet: www.medicon.de



Medicon eG

Gänsäcker 15
D-78532 Tuttlingen

P. O. Box 44 55
D-78509 Tuttlingen

Tel.: +49 (0) 74 62 / 20 09-0
Fax: +49 (0) 74 62 / 20 09-50

E-Mail: sales@medicon.de
Internet: www.medicon.de

Germany

made in Germany